



Smith Business
Services, LLC

19 Wintergreen Avenue East
Edison, New Jersey 08820, USA
Phone: 908-428-7796
Email: shi.xiaowei508@gmail.com

GRN 000779

April 3, 2018

Food and Drug Administration
Center for Food Safety & Applied Nutrition
Office of Food Additive Safety (HFS-200)
5100 Paint Branch Parkway
College Park, MD 20740-3835



Dear Sir/Madam:

On behalf of Baolingbao Biology Co. Ltd., Yucheng, Shandong province, P. R. China, I submit FDA the GRAS notice for Isomaltooligosacchride (IMO), the submission includes:

1. Form 3667 (on CD);
2. GRAS notification for isomaltooligosacchride (on CD);
3. Expert Panel Report for isomaltooligosacchride (on CD);
4. Appendix for isomaltooligosacchride (on CD);
5. Attachment for isomaltooligosacchride (on CD);
6. Signature of Form 3667;
7. Signatures of Expert Panel members; and
8. Signature of GRAS notice.

I also wish to advise you that the CD provided for the agency review if free of viruses.

If additional information or clarification is needed as you proceed with the review, please feel free to contact me via email or telephone.

Sincerely,

(b) (6)

Xiaowei Shi
President
Smith Business Services, LLC
19 Wintergreen Avenue East
Edison, NJ 088200
Phone: 908-428-7796
Email: shi.xiaowei508@gmail.com

FDA USE ONLY

GRN NUMBER	DATE OF RECEIPT
ESTIMATED DAILY INTAKE	INTENDED USE FOR INTERNET
NAME FOR INTERNET	
KEYWORDS	

DEPARTMENT OF HEALTH AND HUMAN SERVICES
Food and Drug Administration

**GENERALLY RECOGNIZED AS SAFE
(GRAS) NOTICE** (Subpart E of Part 170)

Transmit completed form and attachments electronically via the Electronic Submission Gateway (*see Instructions*); OR Transmit completed form and attachments in paper format or on physical media to: Office of Food Additive Safety (*HFS-200*), Center for Food Safety and Applied Nutrition, Food and Drug Administration, 5001 Campus Drive, College Park, MD 20740-3835.

SECTION A – INTRODUCTORY INFORMATION ABOUT THE SUBMISSION

1. Type of Submission (*Check one*)
 New Amendment to GRN No. _____ Supplement to GRN No. _____

2. All electronic files included in this submission have been checked and found to be virus free. (*Check box to verify*)

3. Most recent presubmission meeting (*if any*) with FDA on the subject substance (*yyyy/mm/dd*): _____

4. For Amendments or Supplements: Is your amendment or supplement submitted in response to a communication from FDA? (*Check one*)
 Yes If yes, enter the date of communication (*yyyy/mm/dd*): _____
 No

SECTION B – INFORMATION ABOUT THE NOTIFIER

1a. Notifier	Name of Contact Person Peigong Li	Position or Title Director of Regulatory Affair	
	Organization (<i>if applicable</i>) Baolingbao Biology Co., Ltd.		
	Mailing Address (<i>number and street</i>) 1 Dongwaihuan Road, High-tech Development Zone		
City Yucheng	State or Province Shandong	Zip Code/Postal Code 251200	Country
Telephone Number 86-0534-2126099	Fax Number 86-0534-1216097	E-Mail Address lpg666@126.com	
1b. Agent or Attorney (if applicable)	Name of Contact Person Xiaowei Shi	Position or Title President	
	Organization (<i>if applicable</i>) Smith Business Services, LLC		
	Mailing Address (<i>number and street</i>) 19 Wintergreen Avenue East		
City Edison	State or Province New Jersey	Zip Code/Postal Code 08820	Country
Telephone Number 908-428-7796	Fax Number	E-Mail Address shi.xiaowei508@gmail.com	

SECTION C – GENERAL ADMINISTRATIVE INFORMATION

1. Name of notified substance, using an appropriately descriptive term

Isomalto-oligosaccharide (IMO)

2. Submission Format: *(Check appropriate box(es))*

Electronic Submission Gateway Electronic files on physical media

Paper

If applicable give number and type of physical media

One (1) CD-ROM

3. For paper submissions only:

Number of volumes _____

Total number of pages _____

4. Does this submission incorporate any information in CFSAN's files? *(Check one)*

Yes *(Proceed to Item 5)* No *(Proceed to Item 6)*

5. The submission incorporates information from a previous submission to FDA as indicated below *(Check all that apply)*

a) GRAS Notice No. GRN 000246

b) GRAS Affirmation Petition No. GRP _____

c) Food Additive Petition No. FAP _____

d) Food Master File No. FMF _____

e) Other or Additional *(describe or enter information as above)* _____

6. Statutory basis for conclusions of GRAS status *(Check one)*

Scientific procedures *(21 CFR 170.30(a) and (b))* Experience based on common use in food *(21 CFR 170.30(a) and (c))*

7. Does the submission (including information that you are incorporating) contain information that you view as trade secret or as confidential commercial or financial information? *(see 21 CFR 170.225(c)(8))*

Yes *(Proceed to Item 8)*

No *(Proceed to Section D)*

8. Have you designated information in your submission that you view as trade secret or as confidential commercial or financial information *(Check all that apply)*

Yes, information is designated at the place where it occurs in the submission

No

9. Have you attached a redacted copy of some or all of the submission? *(Check one)*

Yes, a redacted copy of the complete submission

Yes, a redacted copy of part(s) of the submission

No

SECTION D – INTENDED USE

1. Describe the intended conditions of use of the notified substance, including the foods in which the substance will be used, the levels of use in such foods, and the purposes for which the substance will be used, including, when appropriate, a description of a subpopulation expected to consume the notified substance.

Isomalto-oligosaccharide (IMO) is a partially digestible, low calorie sweetener with a relative sweetness level equal to approximately 60% of that of sucrose. The general population uses IMO as a low calorie sweetener in a variety of foods, including, but not limited to, baked goods and baking mixes, beverages and beverage bases, condiments, salad dressings, frozen dairy deserts and mixes, gravies, sauces, hard and soft candies, jams, nut products, processed fruits and vegetables, sugar substitutes, sweet sauces, and toppings. IMO also is used in nutrition bars, tofu, confectionery, candy and chocolate bars, milk products, instant powders, powder milk, yogurts, ice creams, sorbets, sherbets, cereals, soups and home cooking ingredients.

2. Does the intended use of the notified substance include any use in product(s) subject to regulation by the Food Safety and Inspection Service (FSIS) of the U.S. Department of Agriculture?

(Check one)

Yes No

3. If your submission contains trade secrets, do you authorize FDA to provide this information to the Food Safety and Inspection Service of the U.S. Department of Agriculture?

(Check one)

Yes No, you ask us to exclude trade secrets from the information FDA will send to FSIS.

SECTION E – PARTS 2 -7 OF YOUR GRAS NOTICE

(check list to help ensure your submission is complete – PART 1 is addressed in other sections of this form)

- PART 2 of a GRAS notice: Identity, method of manufacture, specifications, and physical or technical effect (170.230).
- PART 3 of a GRAS notice: Dietary exposure (170.235).
- PART 4 of a GRAS notice: Self-limiting levels of use (170.240).
- PART 5 of a GRAS notice: Experience based on common use in foods before 1958 (170.245).
- PART 6 of a GRAS notice: Narrative (170.250).
- PART 7 of a GRAS notice: List of supporting data and information in your GRAS notice (170.255)

Other Information

Did you include any other information that you want FDA to consider in evaluating your GRAS notice?

Yes No

Did you include this other information in the list of attachments?

Yes No

SECTION F – SIGNATURE AND CERTIFICATION STATEMENTS

1. The undersigned is informing FDA that Baolingbao Biology Co., Ltd.
(name of notifier)

has concluded that the intended use(s) of Isomalto-oligosaccharide (IMO)
(name of notified substance)

described on this form, as discussed in the attached notice, is (are) not subject to the premarket approval requirements of the Federal Food, Drug, and Cosmetic Act based on your conclusion that the substance is generally recognized as safe recognized as safe under the conditions of its intended use in accordance with § 170.30.

2. Baolingbao Biology Co., Ltd. *(name of notifier)* agrees to make the data and information that are the basis for the conclusion of GRAS status available to FDA if FDA asks to see them; agrees to allow FDA to review and copy these data and information during customary business hours at the following location if FDA asks to do so; agrees to send these data and information to FDA if FDA asks to do so.

1 Dongwaihuan Road, High-tech Development Zone, Yucheng, Shandong Province, P. R. China
(address of notifier or other location)

The notifying party certifies that this GRAS notice is a complete, representative, and balanced submission that includes unfavorable, as well as favorable information, pertinent to the evaluation of the safety and GRAS status of the use of the substance. The notifying party certifies that the information provided herein is accurate and complete to the best of his/her knowledge. Any knowing and willful misinterpretation is subject to criminal penalty pursuant to 18 U.S.C. 1001.

3. Signature of Responsible Official, Agent, or Attorney	Printed Name and Title	Date (mm/dd/yyyy)
(b) (6)	Xiaowei Shi, President	04/03/2018

SECTION G – LIST OF ATTACHMENTS

List your attached files or documents containing your submission, forms, amendments or supplements, and other pertinent information. Clearly identify the attachment with appropriate descriptive file names (or titles for paper documents), preferably as suggested in the guidance associated with this form. Number your attachments consecutively. When submitting paper documents, enter the inclusive page numbers of each portion of the document below.

Attachment Number	Attachment Name	Folder Location (select from menu) (Page Number(s) for paper Copy Only)
	Form3667_IMO_2018-04-03.pdf	Administrative
	GRAS Notification for IMO-04-03-2018.pdf	Submission
	ExpertPanelReport_IMO_2017-12-25.pdf	Submission
	Appendix_IMO_2018-04-03.pdf	Submission
	Attachment_IMO_2018-04-03.pdf	Submission

OMB Statement: Public reporting burden for this collection of information is estimated to average 170 hours per response, including the time for reviewing instructions, searching existing data sources, gathering and maintaining the data needed, and completing and reviewing the collection of information. Send comments regarding this burden estimate or any other aspect of this collection of information, including suggestions for reducing this burden to: Department of Health and Human Services, Food and Drug Administration, Office of Chief Information Officer, PRStaff@fda.hhs.gov. (Please do NOT return the form to this address.). An agency may not conduct or sponsor, and a person is not required to respond to, a collection of information unless it displays a currently valid OMB control number.

**GRAS NOTIFICATION
FOR ISOMALTOOLIGOSACCHARIDE
MIXTURE (BLB[®] IMO)**

Prepared for: Office of Food Additive Safety (FHS-200)
Center for Food Safety and Applied Nutrition
Food and Drug Administration
5100 Campus Drive
College Park, MD 20740

Submitted by: Smith Business Services, LLC
19 Wintergreen Avenue East
Edison, New Jersey 08820

April 3, 2018

**GRAS NOTIFICATION
FOR ISOMALTOOLIGOSACCHARIDE
MIXTURE (BLB[®] IMO)**

Table of Contents

Part 1 Signed Statements and Certification.....	5
1. GRAS Notification to FDA for Isomalto-oligosaccharide (BLB [®] IMO).....	5
2. Name and Address of Notifier.....	6
3. Common Name of the Notified Substance	6
4. Conditions of Intended use in Food.....	6
5. Basis for GRAS Determination	7
6. Conclusion of GRAS Status for Isomalto-oligosaccharide (BLB [®] IMO).....	7
7. Availability of Information	7
8. Disclosure the Data and Information under the Freedom of Information Act, 5 U.S.C. 552.....	8
9. Statement for this GRAS Notice Submission.....	8
Part 2 Identity, Method of Manufacture, Specifications, and Physical or Technical Effect.....	8
1. Identity	8
2. Method of Manufacture	10
2.1 Manufacturing Process.....	10
2.2 Raw Materials and Processing Aids	11
3. Product Specification and Batch Analysis.....	13
3.1 Product Specifications	13
3.2 Batch Analysis	15
4. Stability of Product	16
Part 3 Dietary Exposure.....	17
1. Intended Uses of BLB [®] IMO Product	17
2. Natural Occurrence of IMO.....	17
3. Formulated Product Exposure.....	18
4. Daily Intake Estimates	18
Part 4 Self-limiting Levels of Use	18
Part 5 Experience Based on Common Use in Food before 1958.....	18

Part 6 Narrative.....	19
1. Absorption, Distribution, Metabolism and Excretion.....	19
2. Published Toxicology Studies.....	19
2.1 Acute Studies.....	19
2.2 Subchronic Studies.....	19
2.3 Genotoxicity Studies.....	23
2.4 Human Tolerance Studies.....	23
3. Safety Evaluations by Authoritative Bodies.....	25
4. Summary.....	26
5. Conclusion.....	29
Part 7 List of Supporting Data and Information.....	29

List of Figures and Tables

Figure 1 Schematic Chart of Manufacturing Process of BLB [®] IMO Products.....	12
Table 1 Summary of Conditions of Intended Uses of BLB [®] IMO Products in Foods.....	6
Table 2 Chemical Description of the Saccharides in IMO Products.....	9
Table 3 Distribution of Major Components of BLB [®] IMO products (%)......	10
Table 4 Standards for Starting Materials and Processing Aids.....	13
Table 5 Organoleptic Specifications of BLB [®] IMO Products	13
Table 6 Physical and Chemical Specifications for BLB [®] IMO Products.....	14
Table 7 Contamination Specifications for BLB [®] IMO Products.....	14
Table 8 Microbiological Specifications for BLB [®] IMO Products.....	14
Table 9 Certificate of Analysis for BLB [®] IMO-90 Syrup.....	15
Table 10 Certificate of Analysis for BLB [®] IMO-90 Powder.....	16
Table 11 History of Traditional Exposure in Japan.....	17
Table 12 Demand for Oligosaccharides in Japan, 2002.....	18
Table 13 Summary of Oral Subchronic and Chronic Animal Toxicity Studies with Isomalto- oligosaccharide (IMO) Products.....	20
Table 14 Summary of Human Tolerance Studies with IMO Products	24

Appendices

- Appendix A1 Analytical Results for BLB[®] IMO-90 Syrup (Lot No. 14070533)
- Appendix A2 Analytical Results for BLB[®] IMO-90 Syrup (Lot No. 14091132)
- Appendix A3 Analytical Results for BLB[®] IMO-90 Syrup (Lot No. 14092633)
- Appendix B1 Analytical Results for Lot BLB[®] IMO-90 Powder (Lot No. 14071631)
- Appendix B2 Analytical Results for Lot BLB[®] IMO-90 Powder (Lot No. 14081032)
- Appendix B3 Analytical Results for Lot BLB[®] IMO-90 Powder (Lot No. 14090231)
- Appendix C1 Microbiological Analytical Results for BLB[®] IMO-90 Syrup (Lot No. 14070533)
- Appendix C2 Microbiological Analytical Results for BLB[®] IMO-90 Syrup (Lot No. 14091132)
- Appendix C3 Microbiological Analytical Results for BLB[®] IMO-90 Syrup (Lot No. 14092633)
- Appendix D1 Microbiological Analytical Results for BLB[®] IMO-90 Powder (Lot No. 14071631)
- Appendix D2 Microbiological Analytical Results for BLB[®] IMO-90 Powder (Lot No. 14081032)
- Appendix D3 Microbiological Analytical Results for BLB[®] IMO-90 Powder (Lot No. 14090231)
- Appendix E GB 8885-2008 Edible corn starch (EN)
- Appendix F GB 8275-2009 Alpha-amylase preparation (EN)
- Appendix G QB 2526-2001 Fungi alpha-amylase (EN)
- Appendix H GB 25594-2010 Enzyme preparations used in food industry (EN)
- Appendix I QB 2525-2001 Alpha-glucosidase (EN)
- Appendix J GB 1886-2008 Sodium carbonate (EN)
- Appendix K GB 1897-2008 Hydrochloric acid (EN)
- Appendix L GB 5175-2008 Sodium hydroxide (EN)
- Appendix M GB 29215-2012 Activated Charcoal (EN)
- Appendix N GB 16579-2013 D001 Cation exchange resins (EN)
- Appendix O HG 2165-91 D301 Anion exchange resins (EN)
- Appendix P GB/T 20881-2007 IMO (EN)

Attachment

- Attachment 1 Vita of Dr. Chi-Tang Ho
- Attachment 2 Vita of Dr. Xiuling Lu
- Attachment 3 Vita of Dr. Shiru Jia

**GRAS NOTIFICATION
FOR ISOMALTOOLIGOSACCHARIDE
MIXTURE (BLB[®] IMO)**

Part 1 Signed Statements and Certification

1. GRAS Notification to FDA for Isomalto-oligosaccharide (BLB[®] IMO)

In accordance with 21 CFR §170 Subpart E consisting of §170.203 through §170.285, Baolingbao Biology Co., Ltd. hereby notifies the agency of its view that the use of isomalto-oligosaccharide (BLB[®] IMO) is not subject to the premarket approval requirements of the Federal Food, Drug, and Cosmetic Act based on scientific procedures and our conclusion that the notified substance is General Recognized as Safe (GRAS) under the conditions of its intended use described in below. In addition, as the agent for Baolingbao Biology Co., Ltd. Xiaowei Shi, hereby certifies that all data and information presented in this notice constitute a complete, representative and balanced submission.

Signed,

(b) (6)

April 3, 2018

Xiaowei Shi
President
Smith Business Services, LLC on behalf of
Baolingbao Biology Co., Ltd.

Date

2. Name and Address of Notifier

Baolingbao Biology Co., Ltd.
1 Dongwaihuan Road, High-tech Development Zone, Yucheng, Shandong Province, P. R. China

3. Common Name of the Notified Substance

Isomaltooligosaccharide, Isomalto-oligosaccharide and IMO

4. Conditions of Intended use in Food

Isomalto-oligosaccharide (IMO) is a non-digestible, low calorie sweetener with a relative sweetness level equal to approximately 60% of sucrose. IMO also supports the proliferation of the beneficial bacteria residing in the large intestine, therefore acts as a prebiotic. The general population uses IMO as a low-calorie sweetener in a variety of foods. The conditions of intended use and levels are summarized in Table 1 below.

Table 1 Summary of Conditions of Intended Uses of BLB[®] IMO Products in Foods

Food Category	Serving Size (g)¹	Maximum Use Level (%)	IMO Amount per Serving (g)
Baked Goods and Baking Mixes	60	25	15
Beverages and Beverage Bases	240	5	12
Breakfast Cereals	50	20	10
Condiments and Relishes	23	20	5
Dairy Product Analogs	240	5	12
Mayonnaise & Mayonnaise –type Dressings	23	30	7
Salad Dressings	30	30	9
Frozen Dairy Desserts and Mixes	100	10	10
Gelatins, Puddings, and Fillings	100	15	15
Gravies and Sauces	70	20	14
Hard Candies	10	100	10
Jams and Jellies	15	75	11
Milk and Milk Products	110	5	5.5
Nut Products	30	10	3
Processed Fruits and Fruit Juices	140	5	7
Snack Foods	30	5	1.5
Soft Candy	35	40	14
Sugar Substitutes	4	100	4
Sweet Sauces, Toppings and Syrups	30	50	15
Processed Vegetables and Vegetable Juices	100	15	15

¹Based on the Reference Amounts Customarily Consumed (RACC) Per Eating Occasion (21 CFR §101.12) Adopted and modified from FDA GRN (2009)

5. Basis for GRAS Determination

This GRAS determination for the use of IMO (BLB[®] IMO) for the intended uses specified above has been shown to be safe, using scientific procedures under the Federal Food, Drug, and Cosmetic Act (FFDCA), as described under 21 CFR 170.30(a) and (b).

6. Conclusion of GRAS Status for Isomalto-oligosaccharide (BLB[®] IMO)

The isomalto-oligosaccharides (BLB[®] IMO) for the intended uses have been shown to be safe and be a GRAS substance. A comprehensive search of the scientific literature for safety and toxicity information on isomalto-oligosaccharides was conducted both by Smith Business Services, LLC and the Expert Panel members. The GRAS status of isomalto-oligosaccharides (BLB[®] IMO) is based on and supported by the views of an independent panel of recognized experts (Expert Panel)¹, qualified by their scientific training and relevant national and international experience to evaluate the safety of IMO as a food ingredient, and information generally available in the public domain on related isomalto-oligosaccharide ingredients, as discussed herein and in the accompanying documents in the Expert Panel evaluation ([Expert Panel Report for the Generally Recognized as Safe \(GRAS\) Status of BLB-IMO, an Isomaltooligosaccharide \(IMO\) Mixture, for use in Foods](#)). The Expert Panel unanimously agrees to the decision that BLB[®] IMO is a GRAS substance under the conditions of intended use in foods described herein.

7. Availability of Data and Information

The data and information that serve as the basis for this GRAS Notification will be made available to the FDA either during or after FDA evaluation of this GRAS notice. Upon FDA request, we will provide FDA a complete copy of data and information either in an electronic format or on paper. Our contact information is as follows:

Smith Business Services, LLC
19 Wintergreen Avenue East
Edison, New Jersey 088200
Phone: (908) 428-7796
Mobile: (908) 205-1834
Email: shi.xiaowei508@gmail.com

8. Disclosure the Data and Information under the Freedom of Information Act, 5 U.S.C. 552

There is no any data and information in this GRAS notice is exempt from disclosure under the Freedom of Information Act, 5 U.S.C. 552.

9. Statement for this GRAS Notice Submission

To the best of our knowledge, Smith Business Services, LLC certifies that this GRAS Notice is a complete, representative and balanced submission.

¹ See Attachments (curriculum vitas) for the members of the Expert Panel documenting their expertise of scientific training and relevant experience to evaluate the safety of food.

Baolingbao Biotechnology Inc. assures that all unpublished information in its possession and relevant to the subject of this determination provided to Smith Business Services, LLC, are true and accurate based on its best knowledge.

Part 2 Identity, Method of Manufacture, Specifications, and Physical or Technical Effect

1. Identity

BLB[®] IMO products have two forms: syrup and solid. The syrup of BLB[®] IMO is colorless or pale yellow and transparent viscous liquid with light and gentle sweetness. The solid form of BLB[®] IMO appears white and amorphous powder with light and gentle sweetness. Both of the syrup and powder are odorless.

Isomalto-oligosaccharides are glucose oligomers with α -D-(1,6) and α -(1,4)-linkages, including isomaltose, panose, isomaltotriose, isomaltopentose and higher branched oligosaccharides (Kaneko *et al.*, 1995; Ketabi, 2001a; Nakakuki, 2002). The majority of oligosaccharides found in IMO consist of 3 to 7 monosaccharide units linked together; however, disaccharides, as well as longer oligosaccharides (up to 9 units) are also present. The disaccharide fraction of IMO consists of α -(1,4)-glycosidic bond linked maltose and α -D-(1,6)-glycosidic bond linked isomaltose, while maltotriose, panose, and isomaltotriose make up the trisaccharide fraction. Maltotetraose, maltopentaose, maltohexaose, maltoheptaose, and small amounts of oligomers with 8 or higher degrees of polymerization (DP) comprise the remaining oligomers in the product. The chemical names, CAS numbers and empirical formulas of some of the lower weight saccharides identified in the IMO products are summarized in Table 2.

Table 2 Chemical Description of the Saccharides in IMO Products

Common Name	CAS No.	Empirical Formula	Chemical Name
<i>Monosaccharides (DP¹1)</i>			
Glucose	50-99-7	C ₆ H ₁₂ O ₆	D-Glucose
<i>Disaccharides (DP²2)</i>			
Maltose	69-79-4	C ₁₂ H ₂₂ O ₁₁	4-O- α -D-glucopyranosyl-D-glucose
Isomaltose	488-40-1	C ₁₂ H ₂₂ O ₁₁	6-O- α -D-glucopyranosyl-D-glucose
<i>Trisaccharides (DP³3)</i>			
Maltotriose	1109-28-0	C ₁₈ H ₃₂ O ₁₆	O- α -D-glucopyranosyl-(1,4)- O- α -D-glucopyranosyl-(1,4)-D-glucose
Panose	33401-87-5	C ₁₈ H ₃₂ O ₁₆	O- α -D-glucopyranosyl-(1,6)- O- α -D-glucopyranosyl-(1,4)-D-glucose
Isomaltotriose	3371-50-4	C ₁₈ H ₃₂ O ₁₆	O- α -D-glucopyranosyl-(1,6)- O- α -D-glucopyranosyl-(1,6)-D-glucose

Table 2 Chemical Description of the Saccharides in IMO Products (Continued)

Common Name	CAS No.	Empirical Formula	Chemical Name
<i>Oligo- and Polysaccharides (DP4 to DP9)</i>			
Isomaltotetraose (DP4)	35997-20-7	C ₂₄ H ₄₂ O ₂₁	O- α -D-glucopyranosyl-(1,6)- O- α -D-glucopyranosyl-(1,6)- O- α -D-glucopyranosyl-(1,6)-D-glucose
Isomaltopentaose (DP5)	6082-32-2	C ₃₀ H ₅₂ O ₂₆	O- α -D-glucopyranosyl-(1,6)- O- α -D-glucopyranosyl-(1,6)- O- α -D-glucopyranosyl-(1,6)- O- α -D-glucopyranosyl-(1,6)-D-glucose
Isomaltohexaose (DP6)	6175-02-6	C ₃₆ H ₆₂ O ₃₁	O- α -D-glucopyranosyl-(1,6)- O- α -D-glucopyranosyl-(1,6)- O- α -D-glucopyranosyl-(1,6)- O- α -D-glucopyranosyl-(1,6)- O- α -D-glucopyranosyl-(1,6)-D-glucose
Isomaltoheptaose (DP7)	6513-12-8	C ₄₂ H ₇₂ O ₃₆	O- α -D-glucopyranosyl-(1,6)- O- α -D-glucopyranosyl-(1,6)- O- α -D-glucopyranosyl-(1,6)- O- α -D-glucopyranosyl-(1,6)- O- α -D-glucopyranosyl-(1,6)- O- α -D-glucopyranosyl-(1,6)-D-glucose
Isomaltooctaose (DP8)	6156-84-9	C ₄₈ H ₈₂ O ₄₁	O- α -D-glucopyranosyl-(1,6)- O- α -D-glucopyranosyl-(1,6)- O- α -D-glucopyranosyl-(1,6)- O- α -D-glucopyranosyl-(1,6)- O- α -D-glucopyranosyl-(1,6)- O- α -D-glucopyranosyl-(1,6)- O- α -D-glucopyranosyl-(1,6)- D-glucose
Isomaltononaose (DP9)	6471-60-9	C ₅₄ H ₉₂ O ₄₆	O- α -D-glucopyranosyl-(1,6)- O- α -D-glucopyranosyl-(1,6)- O- α -D-glucopyranosyl-(1,6)- O- α -D-glucopyranosyl-(1,6)- O- α -D-glucopyranosyl-(1,6)- O- α -D-glucopyranosyl-(1,6)- O- α -D-glucopyranosyl-(1,6)- O- α -D-glucopyranosyl-(1,6)- D-glucose

¹ DP – Degree of polymerization

Excerpted from and modified to GRAS Notice for Vitasugar[™] GRN (FDA GRN 2009).

The compositional analysis of BLB[®] IMO products presented that the syrup and powder formulations contain less than 1% glucose both in IMO syrup and powder; contain 33% and 35% smaller saccharides (fewer than 3 glucose unit), respectively; oligosaccharides with DP3 take up approximately 22% and 20%, respectively. Oligomers (4 or more glucose units) account for

approximately 44%, both in IMO syrup and powder. The major components of BLB[®] IMO products are shown in Table 3.

Table 3 Distribution of Major Components of BLB[®] IMO products (%)

Product Type	Lot No. ¹	Glu	M	IsoM	Mtri	P	IsoMtri	DP4 & Higher	IMO
IMO Syrup	1	0.32	7.27	27.16	1.5	10.14	8.8	44.82	90.91
	2	0.35	7.42	24.93	2	11.08	10.08	44.14	90.23
	3	0.39	8.28	24.22	1.31	12.09	9.7	44.01	90.02
Average		0.35	7.66	25.44	1.60	11.10	9.53	44.32	90.39
IMO Powder	4	0.97	6.92	27.84	1.36	9.9	8.07	44.94	90.75
	5	0.95	8	26.78	1.01	10.52	8.97	43.77	90.04
	6	0.94	8.07	27.64	0.97	9.75	8.22	44.41	90.02
SAverage		0.95	7.66	27.42	1.11	10.06	8.42	44.37	90.27

¹ IMO Syrup Lot No.: 1-14070533; 2-14091132; 3-14092633;

IMO Powder Lot No.: 4-14071631; 5-14081032; 6-14090231

Glu–Glucose; M–Maltose; IsoM–Isomaltose; Mtri–Maltotriose; P–Panose; DP4 & Higher–Tetrasaccharides or higher; IMO–Isomaltooligosaccharides; DP–Degree of polymerization

2. Method of Manufacture

2.1 Manufacturing Process

BLB[®] IMO products are produced, in accordance with current good manufacturing practice (cGMP), from corn starch *via* highly controlled enzyme-hydrolyzed process that converts the starch molecules into isomalto-oligosaccharides mixture (BLB[®] IMO). All starting materials are appropriate for use in food and meet the specifications of the China National Standards.

A starting starch is mixed with water to prepare starch slurry to which salt and water (adjust pH), and α -amylase of bacterial origin from *Bacillus licheniformis* are added to prepare the liquefaction of the starch. The starch particles are broken and partially hydrolyzed *via* high temperature and enzyme in liquefaction. In saccharification process, α -amylase of fungal origin from *Aspergillus oryzae* further hydrolyzes dextrin into maltose and malto-oligosaccharides, and α -glucosidase from *Aspergillus niger* is used to convert α -(1,4)-linkages (maltose and malto-oligosaccharides) to α -(1,6)-linkages that comprise the isomalto units, including isomaltose, penose, isomaltotriose, isomaltotetraose, etc. The temperature of the mixture is increased to at least 90°C to terminate the enzymatic activity. Several down-stream steps, including decolonization, filtration, ion exchange and chromatographic separation, etc., are performed in the manufacturing process of BLB[®] IMO to minimize the potential residues of biocatalysts or other processing aids used during the production. The mixture is then concentrated to syrup type final products. The concentrate is spray-dried to form the powder type final products. The schematic chart of the manufacturing process of BLB[®] IMO is provided in Figure 1.

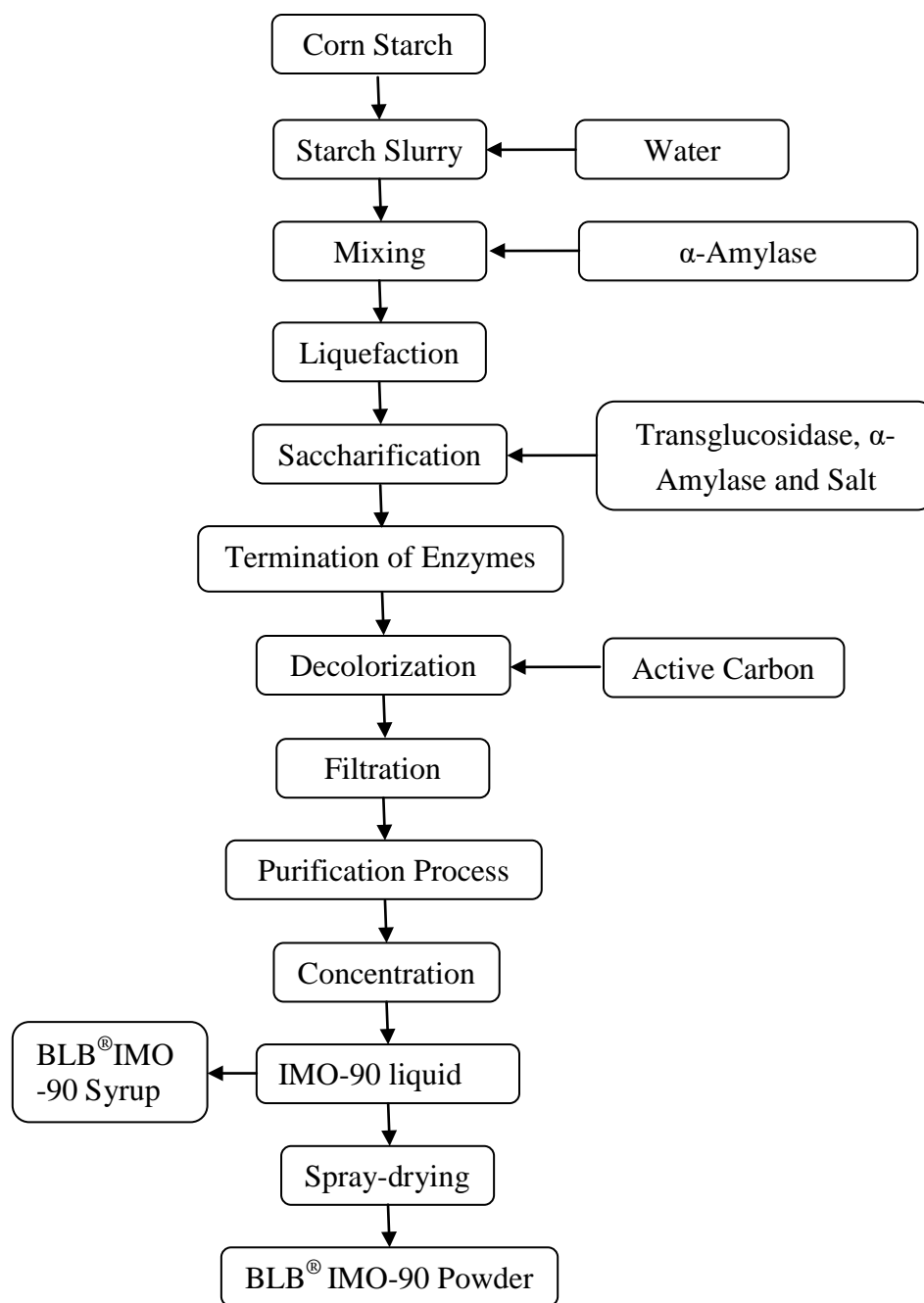

Figure 1 Schematic Chart of Manufacturing Process of BLB[®] IMO Products

2.2 Raw Materials and Processing Aids

The entire manufacturing process is accordance the requirements of cGMP. All water used in the production is treated by mechanical filtrations, and reverse osmosis membrane filtration. The CIP cleaning system covers all production equipment, pipelines and containers/reactors to assure effective cleaning in timely manner, and to assure the safety and stability of the final products. All

starting materials, enzymes, chemicals and reagents and processing aids are appropriate for use in food and meet the related specifications of the China National Standards (GB²), shown in Table 4.

Table 4 Standards for Starting Materials and Processing Aids

Items	China National Standards
Corn Starch	GB/T 8885-2008 (see Appendix E)
Heat-resisting α -Amylase	GB 8275-2009 (see Appendix F) and GB 25594-2010 (see Appendix H)
Fungal α -Amylase	QB ³ 2526-2001 (see Appendix G) and GB 25594-2010 (see Appendix H)
Transglucosidase	QB 2525-2001 (see Appendix I) and GB 25594-2010 (see Appendix H)
Sodium carbonate (Na ₂ CO ₃)	GB 1886-2008 (see Appendix J)
Hydrochloric acid (HCl)	GB 1897-2008 (see Appendix K)
Sodium hydroxide (NaOH)	GB 5175-2008 (see Appendix L)
Activated carbon powder	GB 29215-2012 (see Appendix M)
D001 macroporous strongly acidic styrene type cation exchange resin	GB/T 16579-2013 (see Appendix N)
D301 macroporous weakly basic styrene type anion exchange resin	HB ⁴ 2165-91 (see Appendix O)

3. Product Specification and Batch Analysis

3.1 Specifications of BLB[®] IMO products

The organoleptic specification and the chemical, physical and microbiological specifications for BLB[®] IMO products (syrup and powder) are presented in Table 5 and Table 6, respectively. The contamination and microbiological specifications for BLB[®] IMO products listed in Table 7 and Table 8, respectively. BLB[®] IMO products are consistent with the China National Standard of Isomalto-oligosaccharides specified in GB/T 20881-2007 (see Appendix P).

Table 5 Organoleptic Specifications of BLB[®] IMO Products

Items	Specifications		Analytical Methods
	BLB [®] IMO Syrup	BLB [®] IMO Powder	
Color	Colorless or Pale yellow and transparent viscous liquid	White and amorphous powder	Visual
Taste	Light and gentle sweetness	Light and gentle sweetness	–
Odor	Odorless	Odorless	–
Impurity	No visible impurities	No visible impurities	Visual

² GB – National Standard of the People’s Republic of China

³ QB – Light Industry Standard of the People’s Republic of China

⁴ HB – Chemical Industry Standard of the People’s Republic of China

Table 6 Physical and Chemical Specifications for BLB[®] IMO Products

Items	Specifications		Analytical Methods
	BLB [®] IMO Syrup	BLB [®] IMO Powder	
IMO (% , dry basis)	≥90	≥90	HPLC analysis GB/T ² 20881-2007
IG ₂ +P+IG ₃ ¹ (% , Dry basis)	≥45	≥45	HPLC analysis GB20881-2007
Dried Solid (%)	≥75	N/A	Abbe's refractometer GB/T20885-2007
Moisture (%)	N/A	≤5	Direct Drying GB/T 20884-2007
pH		4.0 – 6.0	GB/T 20885-2007
Solubility (water) (%)	N/A	≥99	Gravimeter GB/T 20884-2007
Transmittance (%)	≥95	N/A	Spectrophotometer GB/T 20885-2007
Sulphated Ash		≤0.3	GB/T 20885-2007

¹ IG₂–Isomaltose; P–Panose; IG₃–Isomaltotriose; ² GB – China National Standards

Table 7 Contaminations

Items	Specifications		Analytical Methods
	Syrup	Powder	
<i>Contamination</i>			
Arsenic (As) (mg/kg)		≤0.5	Hydride generation atomic fluorescence spectrum GB /T 5009.11-2003
Lead (Pb) (mg/kg)		≤0.5	Graphite furnace atomic absorption spectrometry GB 5009.12-2010
Sulfur Dioxide (g/kg)		≤0.04	Distillation GB/T 5009.34-2003

Table 8 Microbiological Specifications for BLB[®] IMO Products

Items	Specifications		Analytical Methods
	Syrup	Powder	
<i>Microbiological Specifications</i>			
Total Aerobic Plate Count (CFU/g)		≤3,000	Plate count GB 4789.2-2010
<i>Escherichia Coli</i> (MPN/g)		≤0.3	MPN count GB 4789.2-2010
<i>Salmonella</i> (CFU/g)		Absent	GB 4789.2-2010

3.2 Batch Analysis

Analysis of non-consecutive representative lots demonstrated compliance with the specifications of the final products (syrup: BLB[®] IMO-90 and powder: BLB[®] IMO-90). The analytical results for the non-consecutive lots provided in the Table 9 and Table 10, respectively.

Table 9 Certificate of Analysis for BLB[®] IMO-90 Syrup (see Appendix A1-A3; C1-C3)

Item	Specification	Batch No.		
		14070533	14091132	14092633
Organoleptic	Colorless or pale yellow; transparent viscous liquid. Light and gentle sweetness. Odorless, no visible impurities.	Light yellow, transparent viscous liquid with mild sweetness, no off-flavor, no visible impurities by normal vision.	Light yellow, transparent viscous liquid with mild sweetness, no off-flavor, no visible impurities by normal vision.	Light yellow, transparent viscous liquid with mild sweetness, no off-flavor, no visible impurities by normal vision.
IMO (% , dry basis)	≥90	90.91	90.23	90.02
IG ₂ +P+IG ₃ (% , dry basis)	≥45	46.09	46.09	46.01
Dried Solid (%)	≥75	75.54	75.42	75.35
pH	4.0 – 6.0	4.7	4.6	5.0
Transmittance (%)	≥95	99	99	99
Sulphated Ash (%)	≤0.3	0.085	0.081	0.069
Sulfur Dioxide (g/kg)	≤0.04	0.00518	0.00650	0.00712
Lead (mg/kg)	≤0.5	Absent	Absent	Absent
Arsenic (mg/kg)	≤0.5	Absent	Absent	Absent
Total Aerobic Plate Count (CFU/g)	≤3,000	<10	<10	<10
<i>Escherichia Coli</i> (MPN/g)	≤0.3	<0.3	<0.3	<0.3
<i>Salmonella</i> (CFU/g)	Absent	Absent	Absent	Absent

Table 10 Certificate of Analysis for BLB[®] IMO-90 Powder (see Appendix B1-B3; D1-D3)

Item	Specification	Batch No.		
		14071631	14081032	14090231
Organoleptic	White and amorphous powder; light and gentle sweetness; odorless; and no visible impurities.	White and amorphous powder with mild sweetness, no off-flavor, no visible impurities by normal vision.	White and amorphous powder with mild sweetness, no off-flavor, no visible impurities by normal vision.	White and amorphous powder with mild sweetness, no off-flavor, no visible impurities by normal vision.
IMO (% , dry basis)	≥90	90.75	90.04	90.02
IG ₂ +P+IG ₃ (% , dry basis)	≥45	45.8	46.27	45.61
Moisture (%)	≤5	4.3	4.0	4.4
pH	4.0 – 6.0	4.7	4.6	4.7
Solubility (%)	≥99	99.8	99.8	99.7
Sulphated Ash (%)	≤0.3	0.085	0.078	0.084
Sulfur Dioxide (g/kg)	≤0.04	0.00641	0.00579	0.00708
Lead (mg/kg)	≤0.5	Absent	Absent	Absent
Arsenic (mg/kg)	≤0.5	Absent	Absent	Absent
Total Aerobic Plate Count (CFU/g)	≤3,000	<10	<10	<10
<i>Escherichia Coli</i> (MPN/g)	≤0.3	<0.3	<0.3	<0.3
<i>Salmonella</i> (CFU/g)	Absent	Absent	Absent	Absent

4. Stability of Product

IMO is very stable under acidic or alkaline conditions (pH 2.0 to 10) (Bioneutra, 2008). In a study performed by BioNeutra, the IMO molecules were found to be >99% stable under high acidic or alkaline conditions, particularly at pH 2.0 in terms of breakdown of glucose molecules when incubated for up to one year at three given storage temperatures: room temperature (25°C), at refrigerator temperature (4°C), and at high temperature (45°C) (Bioneutra, 2008).

The stability of BLB[®] IMO products (IMO-90 powder) was studied using HPLC method to determine the residual rate of IMO under different conditions. Under neutral condition (pH 7.0), IMO was heat treated at 135°C, 121°C and 85°C for 25 sec, 25 min and 30 min, respectively, the results revealed that IMO was very stable. Under acidic conditions of pH 4.2, IMO was very stable at temperatures of 135°C, 121°C and 85°C for 25 sec, 25 min and 30 min, respectively. IMO was stable at 135°C and 85°C for 25 sec and 30 min, respectively in alkaline condition (pH

7.8). However, 89% of IMO was reserved after heated at 121°C for 25 min in the condition of pH 7.8 (Duan. *et al.* 2009).

Part 3 Dietary Exposure

1 Intended Uses of BLB[®] IMO Product

Isomalto-oligosaccharides are a mixture of glucose oligomers with α -(1,6)-glucosidic linkages, such as isomaltose, panose, isomaltotriose, isomaltotetrose, isomaltopentose, and higher branched oligosaccharides (Kaneko *et al.*, 1995; Ketabi, 2001a; Nakakuki, 2002). They are naturally occurred components of the human diet, and have been ingested by humans for hundreds of years as they are naturally found in honey, miso, sake and soy sauce (BioNeutra, 2008). BLB[®] IMO has a sweetness of 40 to 60% relative to that of sucrose, and is intended to use for partial replacement of other currently available sweeteners at levels up to 15 g per serving in a number of conventional foods. The general population uses IMO as a low-calorie sweetener in a variety of foods, including, but not limited to, baked goods and baking mixes, beverages and beverage bases, condiments, salad dressings, frozen dairy desserts and mixes, gravies, sauces, hard and soft candies, jams, nut products, processed fruits and vegetables, sugar substitutes, sweet sauces, and toppings. IMO also is used in nutrition bars, tofu, confectionery, candy and chocolate bars, milk products, instant powders, powder milk, yogurts, ice creams, sorbets, sherbets, jams, jellies, cereals, soups and home cooking ingredients. The conditions of intended use and levels are summarized in Table 1 above.

2. Natural Occurrence of IMO

BioNeutra Inc. (BioNeutra, 2008) indicated that isomalto-oligosaccharides have been ingested by humans for hundreds of years as they are naturally found in honey, miso, sake and soy sauce. Many of the natural products containing IMO have been traditionally consumed in Japan and other Asian countries for a long time. Table 11 shows the per capita consumption of IMO in Japan from three traditional food and beverage sources.

Table 11 History of Traditional Exposure in Japan (BioNeutra, 2008)

Product	Annual Consumption of Product	IMO in Product %	Approximate Annual per Capita consumption of IMO
Honey	300 g	1.0	3 g
Miso	4.6 kg	1.1	50 g
Sake	8 L	0.5	40 g

Miso is soybean combined with rice and other ingredients and aged in cedar vats for up to three years. Its predecessor was known as “hisio,” a seasoning made from fermenting soybeans, wheat, alcohol, salt and other ingredients. This fermented soybean paste was introduced into Japan around the 7th century.

Miso is often consumed daily in soups and used in sauces and marinades. Annual Miso production is about 600,000 MT per year in Japan (Noguchi, 2005). Given a population of 128.9 million, annual per capita consumption of Miso is thus estimated to be 4.6 kg.

Sake is a traditional Japanese alcoholic beverage made from rice. Annual per capita sake consumption has been declining in Japan (9.8 L in 1985; 8.1 L in 2001) and is now down to 6.9 L (Sake World, 2007).

Soy sauce is also reported to contain IMO (Tungland & Meyer, 2002). The data required to determine the per capita consumption of IMO from soy sauce in Japan was not available. Given the IMO consumption data from Table 10 above, along with the knowledge that soy sauce would also make a contribution, it would be reasonable to estimate the annual consumption of IMO in Japan from the traditional sources to be 100 grams.

3. Formulated Product Exposure

BioNeutra (2008) indicated that oligosaccharides, including IMO, are purchased by food processors as ingredients for a variety of functional foods. Table 12 indicates the consumption of oligosaccharides in Japan (2002) based on the demand for the ingredients (Nakakuki, 2003).

Table 12 Demand for Oligosaccharides in Japan, 2002 (BioNeutra, 2008)

Oligosaccharide	Population (million)	Demand (MT)	Annual Per Capita consumption (g)
Malto-oligosaccharide	128.6	15,000	120
Isomalto-oligosaccharide	128.6	15,000	120
Fructo-oligosaccharide	128.6	3,500	30

4. Daily Intake Estimates

The daily intake estimates were based on the replacement for 2 servings per day of sucrose containing foods with BLB[®] IMO. Assuming daily consumption of 2 servings of food with added BLB[®] IMO at the proposed use-level as indicated in Table 1, so a daily intake estimate would be no more than 30 g/person/day.

Part 4 Self-limiting Levels of Use

The use of BLB[®] IMO in food is mainly limited by the desired sweetness intended for a particular food or beverage products. Therefore, the use of BLB[®] IMO in foods at upper use levels is largely self-limiting based on its organoleptic properties.

Part 5 Experience Based on Common Use in Food before 1958

Not applicable.

Part 6 Narrative

1. Absorption, Distribution, Metabolism and Excretion

Isomalto-oligosaccharides are enzymatically manufactured from starch as a mixture of α -(1,6) and α -(1,4) linked glucosides (Keneko *et al.*, 1995). IMO mixture is partially hydrolyzed in the gastrointestinal tract to glucose, and then the glucose is absorbed and utilized by the body of animals and human (FDA GRN, 2009). The undigested portion of IMO are considered as non-digestible oligosaccharides that escape digestion in the stomach and small intestine and reach the colon largely intact and fermented in the colon by microbiota (Ketabi, 2011b; Kohmoto *et al.*, 1992). Animal and human digestive systems accommodate numerous bacteria specialized in fermentation of non-digestible oligosaccharides (NDO) with various structures and degree of polymerization (Ketabi, 2011b). Fermentation yields metabolizable energy for microbial growth and maintenance and also metabolic end products (Topping *et al.*, 2001).

Isomalto-oligosaccharides are widely used as low caloric sweeteners in food industry for many years. As a food ingredient, IMO, as well as other oligosaccharides, has not only a great potential to improve the quality and the physicochemical properties of many foods (due to its mild sweetness, relatively low viscosity, and high moisture retaining properties, etc.), but also with physiologically unique functions, including the improvement of intestinal microflora based on the selective proliferation of *bifidobacteria* and *lactobocilli*, stimulation of mineral absorption, and the improvement of both cholesterol and blood glucose level (Nakakuki, 2002).

2. Published Toxicology Studies

2.1 Acute Studies

Kaneko *et al.* (1990) performed an acute study using IMO mixture in six (24) male Wistar rats, divided into 4 groups with six (6) rats each group, by oral administration IMO mixture for 14 days. The IMO mixture consisting of di-, tri- and larger oligosaccharides (*i.e.*, 52.5, 25.4 and 15.2%, respectively). The dose levels of oral administration were 15.6, 22.0, 31.1 and 44.0 g/kg body weight, respectively. There were not found dead in the dose levels of 15.6, 22.0 and 31.1. Two (2) of the 6 treated rats died in the highest dose level of 44 g/kg bw. The results exhibited a very low order of acute oral toxicity with LD₅₀ values estimated to be greater than 44 g/kg body weight.

2.2 Subchronic and Chronic Toxicological Studies

The subchronic and chronic toxicological studies for IMO mixture were conducted by using rats that were administered IMO mixture in the diet or in the drinking water. The results are summarized in Table 13 below, and briefly described in the following section.

Table 13 Summary of Oral Subchronic and Chronic Animal Toxicity Studies with Isomalto-oligosaccharide (IMO) Products

Species (Strain, sex, no./group)	Duration (day)	Concentration (Dose levels)	Study-end Results ¹	References
Rat (Sprague Dawley)	35	0 (corn starch) or 20% in diet (~0 and 20 g/kg bw/day, respectively)	<ul style="list-style-type: none"> ▪ ↓ in FUE and TG; ▪ No Δ in body weight gain, food intake, cecal contents, and relative organ weights (stomach, small intestine, cecum, colon, lever, kidney, retroabdominal adipose tissue); ▪ No Δ in serum and liver total Ch and PL, and serum HDL-Ch and NEFA. 	Kaneko <i>et al.</i> (1992)
Rat (Sprague- Dawley; male; 5- 6/group)	42	0 (Purina rat chow), 5, 10, or 20% in diet (~0, 5, 10, and 20 g/kg bw/day, respectively)	<ul style="list-style-type: none"> ▪ ↑ in weight cecum at 10 and 20%; ▪ ↓ (dose-dependent) in abdominal fat gain (normalized for food intake); ▪ No Δ in food intake, body weight gain, and absolute heart, spleen, kidneys, lungs, and brown and white tissue weight. 	Day & Chung (2004)
Rat (Wistar; male; 8/group)	365 (1 year)	0 or 3% in drinking water (~0 and 3-5 g/kg bw/day, respectively)	<ul style="list-style-type: none"> ▪ No Δ in body weight gain and body weights, AST, ALP, LDH, Cre, BUN(↓ in 1st month), UA, total Ch, TG, WBC and RBC; ▪ ↓ in serum Hb, and ALT; ▪ No gross or histopathological abnormalities; ▪ ↑ in Lactobacillus count and bifidobacterium frequency of occurrence; ▪ ↓ Clostridium. 	Kaneko <i>et al.</i> (1990)

No Δ = No variations between test and control animals; ALP = Alkaline phosphatase; ALT = Alanine aminotransferase; AST = Aspartate aminotransferase ; BUN = Blood urea nitrogen; Ch = Cholesterol; Cre = Creatinine; FUE = Food utilization efficiency; Hb = Hemoglobin; HDL-Ch = High density lipoprotein cholesterol; Ht = Hematocrit; LDH = Lactate dehydrogenase; NEFA = Non-esterified fatty acids; PL = Phospholipids; RBC = Red blood cell count; TG = Triglycerides; UA = Uric acid; WBC = White blood cell count.

¹ Study-end results unless otherwise indicated; Results are provided for test animals relative to controls.

Excerpted from and modified to FDA GRN 2009.

In the single dose toxicity study performed by Kaneko *et al.* (1990), total sixty four (64) male Wistar rats were randomly divided into two (2) groups with 32 per group. The testing group received 3% of an IMO product in drinking water providing daily that dose level in the range of approximately 3 to 5 g/kg bw for a period of 12 months. The control group did not receive any IMO during the test. The interim clinical evaluations were conducted at months 1, 3 and 6 with 8 rats each time for both testing and control group. At study completion, blood samples were collected for standard clinical chemistry analysis and the animals were sacrificed for

histopathological examinations. Body weights of IMO-treated males remained comparable to those of control animals during the treatment period. At study completion, significant variations in hematology and clinical chemistry parameters were limited to decreases in levels of hemoglobin, hematocrit, and alanine aminotransferase (ALT) in test animals compared to controls. However, neither the gross necropsy nor the histopathological examination revealed any abnormalities related to the administration of the IMO preparation. In additional detailed analysis of white blood cell levels conducted to determine any potential immune stimulatory effects, no changes were observed in the absolute number of white blood cells of test rats relative to levels reported in the control group, whereas significant variations in total and individual subgroups of lymphocytes (*i.e.*, elevated levels of total lymphocytes, total T cells, B cells, and helper and suppressor T cells) were limited to the first treatment month. The intake of IMO by the rats in long-term studies was estimated to be 2.7 to 5.0g/kg/day.

In a short-term animal study, several different digestible and non-digestible sugars were compared; a group of 8 male Sprague-Dawley rats was administered 20% of an IMO mixture in the diet (approximately 20 g/kg bw/day) for a period of 35 days (Kaneko *et al.*, 1992). In comparison to the basal diet (corn starch) control group, final body weights, body weight gain, and food intake of IMO-treated rats were slightly reduced, but not at levels of statistical significance. A statistically significant decrease was, however, observed in the food utilization efficiency of IMO-treated rats. Relative weights of a series of major organs including the liver in rats treated with the IMO mixture were comparable to those reported in the basal diet controls.

In a 6-week study (Day and Chung, 2004), the 2-month-old male Sprague-Dawley rats were divided into four groups of 5 to 6 rats per group. One group (the control) was fed standard rat chow (Purina rat chow). The other three groups were fed IMO-supplemented rat chow at a concentration of 5%, 10%, and 20%, respectively (approximately 5, 10 and 20 g/kg bw/day, respectively). The food intake and weight gain was measured twice a week for six weeks. At the end of six weeks, the rats were sacrificed to examine the weights of the major organs. There were no significant differences in food intake (although a trend toward an increase in the IMO food intake was seen; $p < 0.058$). Weight gain and weights of a series of major organs, including heart, spleen, kidneys, lungs, brown adipose tissue, and white adipose tissue, were determined, and the results were comparable to the control. However, there were significant differences in the weight of the caecum with an increased weight measured especially in the 10% and 20% IMO groups. This probably indicates an increase in the population of fermentation bacteria. Blood was also taken for future analysis. A significant effect of the IMO concentration on the abdominal fat gain when normalized for food intake was observed. A significant decrease was seen in abdominal fat with increasing levels of IMO in the feed. These data indicate that IMO-supplemented food is non-toxic. More importantly, this indicates that IMO-supplemented food can reduce either the

formation or deposition of fat. It is also predicted that the blood glucose level will be less in rats fed the IMO-supplemented food.

Ly *et al.* (1999) conducted a study for evaluating the effects of oligosaccharides (fructo- or isomalto-) contained in sponge cake on blood lipids and intestinal physiology in rats. Even though the study was designed primarily to assess the potential effects of IMO preparations on metabolic end-points and intestinal physiology, but it also included determinations of body weights and body weight gain, food intake, and liver and/or kidney weights. The experimental diet was mixed with 30% sponge cakes, which presents 12% of IMO on the diet (sponge cakes with 40% of the sucrose content replaced by IMO mixture and added to diet at 30%). Normal male Sprague-Dawley rats weighing about 530 g were randomly assigned to three groups and placed on experimental diets and deionized water at free access for 25 days. Rats in control group received a diet with sponge cake containing sucrose at 21.58 g/100 g diet and rats in the other two groups received diets mixed with sponge cakes of which 40% sucrose was replaced with both fructooligosaccharide (FO) and in isomaltooligosaccharide (IMO) (approximate at the level of 12%). The results exhibited no significant differences in efficiency of food, liver weight and intestinal length were observed among groups. The water contents of fresh feces of IMO and FO groups were higher than control. Dry fecal weight increased significantly in isomaltooligosaccharide (IMO) group. The pH of cecal contents decreased significantly in two oligosaccharide groups.

Chai *et al.* (2001) conduct a study to examine the effects of dietary oligosaccharide on the blood glucose and serum lipid composition in streptozotocin (STZ)-induced diabetic rats. Sprague-Dawley male rats were randomly assigned to one normal and four STZ-induced diabetic groups. Diabetic groups were classified to basal diet (DM group), 10% xylooligosaccharide diet (DM-XO group), 10% isomaltooligosaccharide (DM-IMO group), and 10% fructooligosaccharide (DM-FO). Diabetes was experimentally induced by intravenous injection of 50 mg/kg of body weight of STZ in citrate buffer (pH 4.3) after feeding of experimental diets for 4 weeks. These rats were fed with experimental diets in diabetic state for further 4 weeks. The oligosaccharide diets were not affected on the body weight, food intakes and food efficiency ratio. The oligosaccharide diets were also not affected on the weights of liver, kidney and small intestine, but the weight of cecum was significantly increased on the groups of xylooligosaccharide and isomaltooligosaccharide diet.

Seven older male subjects participated in this study that consisted of a 30-day control low fiber period followed by a 30-day IO-supplemented (10 g active components) experimental period. Bowel functions such as defecation, enema use and bloating were monitored daily. Fecal characteristics such as wet and dry stool weights, stool moisture, pH and short-chain fatty acid contents were determined on five-day fecal composites collected in each period. Incorporation of IO significantly increased the defecation frequency, wet stool output and dry stool weight by two fold, 70% and 55%, respectively. Fecal acetate and propionate concentrations significantly

increased by nearly two and a half fold with IO supplement. The increase in stool bulk was mainly attributed by increased bacterial mass. Mean serum sodium concentration decreased in the experimental period while other blood characteristics did not change significantly.

Anthropometric parameters and nutrient intake remained constant throughout the study.

Consumption of IO effectively improved bowel movement, stool output and microbial fermentation in the colon without any adverse effect observed in this study (Chen, *et al.*, 2001).

2.3 Genotoxicity Studies

A mutagenicity test by Ames' method was carried out to evaluate *in vitro* in a standard battery of *Salmonella typhimurium* (i.e., TA98, TA100, TA1535 and TA1537) and in *Escherichia coli* WP2uvrA with and without metabolic activation, the IMO mixture did not induce significant increases in the number of revertant colonies at concentration of up to 10% per plate (Kaneko *et al.*, 1990). In a chromosome aberration test using Chinese hamster lung (CHL) cells were also carried out to evaluate chromosome aberration. The IMO mixture failed to significantly increase the number of chromosome aberrations in Chinese hamster lung (CHL) cells at concentrations of up to 3% in either the absence or presence of a bioactivation system following a 24- or 48-hour incubation period (Kaneko *et al.*, 1990).

2.4 Human Tolerance Studies

The human tolerance studies conducted with IMO are summarized in Table 12. IMO are generally tolerated at higher dosages compared to other non-digestible oligosaccharides (Kaneko *et al.*, 1994).

Several human studies ranging from 7 to 30 days in duration that were primarily designed to assess various indices related to the putative prebiotic properties of IMO preparation, also evaluated their tolerability. Additionally, several authors have reported a threshold value of 1.5 g/kg body weight or greater (approximately 90 g in the case of a 60kg individual) for the induction of transient diarrhea resulting from the consumption of single dose of isomalto-oligosaccharides (Oku and Nakamura, 2002).

While ingestion of single 20 g doses of FOS or galactosyl-sucrose induced various abdominal discomforts (e.g., distention, borborygmus, flatus), no gastrointestinal disturbances were observed following consumption of up to 40 g of an IMO product (Oku and Nakamura, 2003). Similarly, no gastrointestinal symptoms were reported by study participants following repeat ingestion of an IMO mixture at dose levels of 10 to 15 g for a period of 3 weeks, with a 1-week IMO free interval between 2 consecutive weeks of treatment followed by another 7 days of IMO ingestion (Kaneko *et al.*, 1993).

Conversely, in 2 other studies, increases were reported in the severity of incidence of various gastrointestinal symptoms (e.g., flatulence, abdominal pain and distention, borborygmus) following

consumption of 20 or 30 g of IMO mixture for 10 or 28 days in comparison to baseline levels. However, in none of these studies did the subjects experience increased incidences or severity of diarrhea (Kohmoto *et al.*, 1988; Wang *et al.*, 2001). Moreover, increased flatulence reported by individuals in the study conducted by Kohmoto *et al.* (1988) was only temporary and subsided with treatment, suggesting that the microfloral population adapted to changes in the amount of undigested material passing into the colon. In a study conducted with a group of elderly men with a history of chronic constipation, a 3-fold increase in defecation frequency and significantly greater wet and dry fecal weight per day per stool sample were reported following consumption to a 30-day control period; however, changes in bowel movements and stool characteristics were not accompanied by any reports of gastrointestinal discomforts (Chen *et al.*, 2001). Moreover, in a placebo-controlled, double-blind study, gastrointestinal disturbances in subjects consuming daily 10 g of an IMO preparation for a period of 7 days increased only in comparison to a 7-day run-in period, but not in comparison to the placebo (Bouhnik *et al.*, 2004). None of the subjects experienced diarrhea.

In 2 studies which also included evaluations of clinical biochemistry, no significant variations were observed in several clinical chemistry parameters (e.g., total protein, albumin, blood urea nitrogen, creatinine) when elderly subjects or hemodialysis patients were provided daily 24 or 30 g of an IMO preparation for 30 and 28 days, respectively (Chen *et al.*, 2001; Wang *et al.*, 2001). In comparison to pre-treatment values, the hemodialysis patients did however, exhibit elevated hemoglobin and hematocrit values following ingestion of the IMO mixture, which as suggested by the authors may have been at least in part due to enhanced iron absorption (Wang *et al.*, 2001).

The Summary of human tolerance studies with IMO products is listed in Table 14 below.

Table 14 Summary of Human Tolerance Studies with IMO Products

Study Population and design	Duration	Daily Dose Levels	Results	Reference
9 healthy males (~26 years old) and 29 females (~23 years old)	Single dose	10, 20 or 40 g	No GI disturbances	Oku and Nakamura (2003)
81 healthy males and 119 females (~30 years old) (8 ingested IMO mix); double-blind placebo-controlled study	7 day run-in and 7-day treatment period	0 (placebo) or 10 g/day (2 equal portions)	<ul style="list-style-type: none"> ▪ ↑ (slight) in excess flatus, bloating, borborygmi, and abdominal pains (all mild symptoms) vs. run-in period, however, no Δ in any of the GI symptoms vs. placebo control; ▪ None of the subjects experienced diarrhea. 	Bouhnik <i>et al.</i> (2004)

Table 14 Summary of Human Tolerance Studies with IMO Products (Continued)

Study Population and design	Duration	Daily Dose Levels	Results	Reference
6 healthy males (26-48 years old)	10 days	20 g/day	<ul style="list-style-type: none"> ▪ None of the subjects experienced diarrhea; ▪ Only transient increase in flatulence in 2/24 subjects. 	Kohmoto <i>et al.</i> (1988)
18 older subjects (5 males and 13 females; 50-93 years old)	14 days			
20 healthy females and 11 males (22 subjects w/history of constipation) (~27-30 years old)	21 days (total) ²	10 or 15 g	<ul style="list-style-type: none"> ▪ No GI disturbances ▪ ↑ defecation frequency in constipated subjects w/15 g IMO mix vs. 1st week. 	Kaneko <i>et al.</i> (1993)
8 males and 12 females hemodialysis patients (~64 years old)	14 days run-in and 28-day treatment period	30 g/day (2 equal portions)	<ul style="list-style-type: none"> ▪ ↑ in severity of distension (10%)¹, tominia (10.5%), borborygmi (6.1%), spasms (4.5), and in bowel movements; ▪ No Δ in diarrhea (5%); <p><u>Clinical Chemistry</u></p> <ul style="list-style-type: none"> ▪ ↑ in Hb, and HDL-Ch vs. run-in; ▪ ↓ in Tg, and total Ch; ▪ No Δ in glucose, albumin, total protein, BUN, Cre, Ca²⁺, P, and LDL-Ch. 	Wang <i>et al.</i> (2001)
7 elderly males w/history of constipation (~75 year old)	30-day run-in and 30-day treatment period	↑ from 8 to 24 g (1 st 10 days)	<ul style="list-style-type: none"> ▪ ↑ in defecation frequency and wet and dry fecal weight per day and stool sample; ▪ No reports of GI disturbances. <p><u>Clinical Chemistry</u></p> <ul style="list-style-type: none"> ▪ ↑ in Na⁺; ▪ No Δ glucose, total protein, albumin, TG, Ch, HDL-Ch, Ca²⁺, P, and K vs. run-in. 	Chen <i>et al.</i> (2001)

No Δ=No change; BUN=Blood urea nitrogen; Ca²⁺=Calcium; Cre=Creatinine; Ch= Cholesterol; Hb = Hemoglobin; GI=Gastrointestinal;; HDL-Ch=High density lipoprotein cholesterol; Ht=hematocrit; LDL-Ch=low density lipoprotein cholesterol; K=Potassium; Na⁺=Sodium; P=Phosphorus; TG=Triglycerides.

¹ Percent in parentheses indicates percent of patients experiencing GI symptoms.

² 1st week run-in period; 2nd and 3rd week IMO mix ingestion; 4th week break; 5th week IMO mix ingestion.

Excerpted from FDA GRN (2009)

3. Safety Evaluations by Authoritative Bodies

The regulatory status for IMO used in foods is widely accepted in world. Currently, U.S. FDA has not questions for the GRAS notice issued by BioNeutra Inc. in 2009 (FDA GRN, 2009). Canada Health approved Vitasugar[™] (IMO produced by BioNeutra Inc.) as a novel food in 2009 (Health Canada, 2009).

In 2009, UK Food Standards Agency (FSA) evaluated the application from BioNeutra Inc. regarding placing isomalto-oligosaccharide on the EU market as a novel food ingredient. The application was evaluated by the Advisory Committee on Novel Foods and Processes (ACNFP), the independent Committee, and concluded that isomalto-oligosaccharide meets the criteria for acceptance as a novel food in its initial assessment report in December 2012 (FSA ACNFP 2013). Japan and China are also permitted to use IMO as a food ingredient. Isomalto-oligosaccharide is considered as a starch-related oligosaccharide and was used as a prebiotic in healthy foods since the early 1980s to the late 1990s (Nakakuki T. 2003) in Japan. Isomalto-oligosaccharide is permitted to use in foods as an ingredient in China, and established the national standard of GB/T 20881-2007 (see Appendix P) for IMO in China. According to this standard, IMO is a mixture consisting of isomaltose, panose, isomaltraose, isomaltotetraose, as well as oligosaccharides with higher degree of polymerization.

4. SUMMARY

The majority of oligosaccharides found in BLB[®] IMO consist of 2 or higher monosaccharide units linked together. The disaccharide fraction of BLB[®] IMO consists of the α -(1,4)-glycosidic bond linked maltose and the α -D-(1,6)- glycosidic bond linked isomaltose, while maltotriose, panose, and isomaltotriose make up the trisaccharide fraction. Maltotetraose, maltopentaose, maltohexaose, maltoheptaose, and small amounts of oligomers with 8 or higher degrees of polymerization (DP) comprise the remaining oligomers in the product.

BLB[®] IMO products are proposed for use as an alternative sweetener as a partial replacement for current available sweeteners in a variety of foods, including baked goods and baking mixes, beverages and beverage bases, breakfast cereals, chewing gum, dairy product analogs, egg products, fats and oils, frozen dairy desserts & mixes, gravies and sauces, hard candy, infant and toddler food (not include infant formula), milk products, processed fruits and fruit juices, soft candy, soups and soup mixes, at use levels of 1.5 to 15 g/serving (21 CFR 101.12, reference amounts customarily consumed eating occasion). The nutritive value of IMO preparations was estimated to be approximately 2.7 to 3.3 kcal/g or 70 to 80% relative to that of maltose (Kaneko *et al.*, 1992; Kohmoto *et al.*, 1992). BLB[®] IMO products are proposed for use at use-level of up to 15 g/serving. Assuming that a person will consume 2 servings of food per day to which BLB[®] IMO has been added at levels of up to 15 g/serving, a daily intake level of not more than 30 g/BLB[®] IMO/person is estimated.

BLB[®] IMO is produced, in accordance with current good manufacturing practice (cGMP), from corn starch *via* enzyme-hydrolyzed process that converts the starch molecules into isomalto-oligosaccharides mixture, followed by purification and concentration of the resulting IMO mixture to form a powder or syrup product. All water used in the production is treated by mechanical filtrations, and reverse osmosis membrane filtration. The CIP cleaning system covers all

production equipment, pipelines and containers/reactors to assure effective cleaning in timely manner, and to assure the safety and stability of the final products. All starting materials, including enzymes, chemicals, reagents and processing aids are appropriate for use in food and meet the related specifications of the China National Standards.

IMO is very stable under acidic or alkaline conditions (pH 2.0 to 10) (Bioneutra, 2008). The stability of BLB[®] IMO products was studied, and the results are shown in Fig. 3 and Fig. 4 below. The results revealed that IMO was very stable under conditions of pH ranging from 2 to 4 and temperature from 60 to 120 °C, and was stable at high temperature of up to 180 °C, while sucrose was decomposed rapidly in comparison to IMOs. The stability of BLB[®] IMO products (IMO-90 powder) was studied using HPLC method to determine the residual rate of IMO under different conditions. Under neutral condition (pH 7.0), IMO was heat treated at 135°C, 121°C and 85°C for 25 sec, 25 min and 30 min, respectively, the results revealed that IMO was very stable. Under acidic conditions of pH 4.2, IMO was very stable at temperatures of 135°C, 121°C and 85°C for 25 sec, 25 min and 30 min, respectively. IMO was stable at 135°C and 85°C for 25 sec and 30 min, respectively in alkaline condition (pH 7.8). However, 89% of IMO was reserved after heated at 121°C for 25 min in the condition of pH 7.8 (Duan. *et al.* 2009).

The organoleptic specification, the chemical, physical and microbiological specifications for BLB[®] IMO products (syrup and powder) are compliant to the China National Standard of Isomaltooligosaccharides specified in GB/T 20881-2007 (see Appendix P).

The use of BLB[®] IMO in food is mainly limited by the desired sweetness intended for a particular food or beverage products. Therefore, the use of BLB[®] IMO in foods at upper use levels is largely self-limiting based on its organoleptic properties.

The regulatory status for IMO used in foods is widely accepted in world. Currently, U.S. FDA has not questions for the GRAS notice issued by BioNeutra Inc. in 2009 (FDA GRN, 2009). Canada Health approved Vitasugar[™] (IMO produced by BioNeutra Inc.) as a novel food in 2009 (Health Canada, 2009). In 2009, UK Food Standards Agency (FSA) evaluated the application from BioNeutra Inc. regarding placing isomalto-oligosaccharide on the EU market as a novel food ingredient. The application was evaluated by the Advisory Committee on Novel Foods and Processes (ACNFP), the independent Committee, and concluded that isomalto-oligosaccharide meets the criteria for acceptance as a novel food in its initial assessment report in December 2012 (FSA ACNFP 2013). Japan and China are also permitted to use IMO as a food ingredient. Isomalto-oligosaccharide is considered as a starch-related oligosaccharide and was used as a prebiotic in healthy foods since the early 1980s to the late 1990s (Nakakuki T. 2003) in Japan. Isomalto-oligosaccharide is permitted to use in foods as an ingredient in China, and established the national standard of GB/T 20881-2007 (see Appendix P) for IMO in China. According to this standard, IMO is a mixture consisting of isomaltose, panose, isomaltraose, isomaltotetraose, as well as oligosaccharides with higher degree of polymerization.

IMO mixture is partially hydrolyzed in the gastrointestinal tract to glucose, and then the glucose is absorbed and utilized by the body of animals and human (FDA GRN, 2009). The undigested portion of IMO are considered as non-digestible oligosaccharides that escape digestion in the stomach and small intestine and reach the colon largely intact and fermented in the colon by microbiota (Ketabi, 2011b; Kohmoto *et al.*, 1992). Animal and human digestive systems accommodate numerous bacteria specialized in fermentation of non-digestible oligosaccharides (NDO) with various structures and degree of polymerization (Ketabi, 2011b). Fermentation yields metabolizable energy for microbial growth and maintenance and also metabolic end products (Topping *et al.*, 2001).

The animal toxicity studies exhibited sufficient support that there were not observed adverse effects when consuming IMO mixture. The results of an acute study showed that a very low order of acute oral toxicity with LD₅₀ values estimated to be greater than 44 g/kg body weight (Kaneko *et al.*, 1990). A mutagenicity test by Ames' method showed that the IMO mixture did not induce significant increases in the number of revertant colonies at concentration of up to 10% per plate (Kaneko *et al.*, 1990). In a chromosome aberration test using Chinese hamster lung (CHL) cells, there were not significantly increase the number of chromosome aberrations in Chinese hamster lung (CHL) cells at concentrations of up to 3% in either the absence or presence of a bioactivation system following a 24- or 48-hour incubation period (Kaneko *et al.*, 1990).

In several human studies, ingestion of single 20 g doses of FOS or galactosyl-sucrose induced various abdominal discomforts (e.g., distention, borborygmus, flatus), no gastrointestinal disturbances were observed following consumption of up to 40 g of an IMO product (Oku and Nakamura, 2003). Similarly, no gastrointestinal symptoms were reported by study participants following repeat ingestion of an IMO mixture at dose levels of 10 to 15 g for a period of 3 weeks, with a 1-week IMO free interval between 2 consecutive weeks of treatment followed by another 7 days of IMO ingestion (Kaneko *et al.*, 1993). BLB[®] IMO products are expected to be well tolerated at the intake levels from the proposed use-levels of 30 g/day.

In addition used as low caloric sweetener in food industry, IMO also exhibit certain physiologically unique functions, including the improvement of intestinal microflora based on the selective proliferation of *bifidobacteria* and *lactobocilli*, stimulation of mineral absorption, and the improvement of both cholesterol and blood glucose level (Nakakuki, 2002).

The scientific evidence presented above supports that BLB[®] IMO, a mixture of isomalto-oligosaccharides, would not produce adverse effects on human health under the condition of intended use described herein. As supported by the results of the published animal studies and human studies, there is no risk of systemic toxicity related to the ingestion of IMO. The data and information summarized in this report support the conclusion that BLB[®] IMO products, meeting appropriate food grade specifications, and manufactured in accordance with current good

manufacturing practice, would be GRAS substance under the condition of intended use based on scientific procedure.

5. Conclusion

A comprehensive search of the scientific literature for safety and toxicity information on isomalto-oligosaccharides was conducted and analyzed. Based on the data and information public available, as well as the opinion of the Expert Panel regarding the safety of IMO under the conditions of intended use in foods, we conclude that BLB[®] IMO, a mixture of isomalto-oligosaccharides, meeting appropriate food-grade specifications and produced in accordance with current Good Manufacturing Practice, is Generally Recognized as Safe (GRAS) based on scientific procedures under the conditions of intended use in foods specified herein.

Part 7 List of Supporting Data and Information

21 CFR 101.12 –Reference Amounts Customarily Consumed Per Eating Occasion.

<http://www.gpo.gov/fdsys/granule/cfr-2012-title21-vol2/cfr-2012-title21-vol2-sec101-12>.

BioNeutra, 2008. Application for the approval of isomalto-oligosaccharide (IMO). Regulation (EC) No 258/97 of the European Parliament and of the Council of 27th January 1997 concerning novel foods and novel food ingredients.

http://acnfp.food.gov.uk/sites/default/files/mnt/drupal_data/sources/files/multimedia/pdfs/isomaltodossier.pdf.

Bouhnik Y., Raskine L., Simoneau G., Vicaut E., Neut C., Flourie B., Brouns F., Bornet FR. 2004. The capacity of nondigestible carbohydrates to stimulate fecal bifidobacteria in healthy humans: a double-blind, randomized, placebo-controlled, parallel-group, dose-response relation study. *Am. J. Clin. Nutr.* 80(6):1658-64.

Chai YM. and Rhee SJ. 2001. Effects of dietary oligosaccharides on the blood glucose and serum lipid composition in streptozotocin-induced diabetic rats. *J. Korean Soc. Food Sci. Nutr.* 30(4):710-16 [Korean with English summary].
<http://img.kisti.re.kr/originalView/originalView.jsp>.

Chen HL., Lu YH., Lin JJ., Ko LY. 2001. Effects of isomalto-oligosaccharides on bowel functions and indicators of nutritional status in constipated elderly men. *J. Am Coll Nutr.* 20(1):44-49.

Day DF., Chung CH. 2004. Isomaltooligosaccharides from leuconostoc as neutraceuticals. US

Patent No.: US2004/0235789.

<https://docs.google.com/viewer?url=patentimages.storage.googleapis.com/pdfs/US20040235789.pdf>.

Duan SF., Zhang JZ., Zhou ZQ., Lin J. 2009. Effect of heat treatment to the stability of functional oligosaccharides. Food and Fermentation Industries. Vol. 35, No. 3 (Total 255).

FDA GRN 246, 2009. GRAS Notice for Vitasugar[™], an Isomalto-oligosaccharide (IMO) Mixture, for use in foods.

<http://www.fda.gov/downloads/Food/IngredientsPackagingLabeling/GRAS/NoticeInventory/UCM264134>.

FSA ACNFP, 2013. Isomalto-oligosaccharide as a novel food ingredient.

http://acnfp.food.gov.uk/sites/default/files/mnt/drupal_data/sources/files/multimedia/pdfs/isomalto.pdf.

Health Canada, 2009. Novel Food Decisions: Isomalto-oligosaccharides (VitaFiber[™]).

<http://www.hc-sc.gc.ca/fn-an/gmf-agm/appro/isomalto-oligosaccharide-eng.php>.

KANEKO T., KOHMOTO T., KIKUCHI H., FUKUI F., SHIOTA M., YATAKE T., TAKAKU H., IINO H. 1992. Digestibility of Isomaltooligosaccharides by Rats and Effects on Serum Lipids. Journal of the agricultural chemical society of Japan,;VOL. 66; NO.8; 1211-1220 [Japanese with English summary].

http://astp.jst.go.jp/modules/search/index.php?page=DocumentDetail&journalId=0002-1407_66_8_Digestibility+of+Isomaltooligosaccharides+by+Rats+and+Effects+on+Serum+Lipids.N%2FA.

Kaneko T., Kohmoto T., Kikuchi H., Shiota M., Iino H., and Mitsuoka T. 1994. Effects of isomaltooligosaccharides with different degrees of polymerization on human fecal bifidobacteria. Biosci. Biotech. Biochem., 58(12), 2288-2290.

Kaneko T., Kohmoto T., Kikuchi H., Shiota M., Yatake T., Iino H., Tsuji K. 1993. Effects of isomaltooligosaccharides intake on defecation and intestinal environment in healthy volunteers. Journal of Home Economics of Japan. 44(4):245-254. [Japanese with English summary and Tables]. https://www.jstage.jst.go.jp/article/jhej1987/44/4/44_4_245/pdf.

Kaneko T., Yokoyama A., and Suzuki M. 1995. Digestibility characteristics of isomalto-oligosaccharides in comparison with several saccharides using the rat jejunum loop method.

Biosci. Biotech. Biochem. 59 (7), 1190-1194.

Kaneko, T., Kohmoto T., Fukui F., Akiba T., Suzuki S., Hirao A., Nakatsuru S., Kanisawa M. 1990. Acute and chronic toxicity and mutagenicity studies on isomaltooligosaccharides, and the effects on peripheral blood lymphocytes and intestinal microflora. Food Hygiene and Safety Science. VOL.31; NO.5; 394-N/A.

Ketabi 2011b-Prebiotic activity of isomalto-oligosaccharides (thesis).

<https://era.library.ualberta.ca/public/datastream/get/uuid:1b848ea1-d05f-415c-b44e-45966b3e9e48/DS1>.

Ketabi A., Dieleman L.A. and Gänzle M.G. 2011a. Influence of isomalto-oligosaccharides on intestinal microbiota in rats. Journal of Applied Microbiology, May 2011, 110 (5), 1297–1306.

Kohmoto T., Fukui F., Takaku H., Machida Y., Arai M., and Mitsuoka T. 1988. Effect of isomalto-oligosaccharides on human fecal flora. Bifidobacteria Microflora, Vol. 7(2), 61-69.

Kohmoto T., Tsuji K., Kaneko T., Shiota M., Fukui F., Takaku H., Nakagawa Y., Ichikawa T., Kobayashi S. 1992. Metabolism of ¹³C-isomaltooligosaccharides in healthy men. Biosci. Biotech. Biochem., Vol. 56, 973-940

Ly SY., Lee MR., and Lee KA. 1999. Effects of cakes containing sponge oligosaccharides on blood lipids and intestinal physiology in rats. J. Korean Soc. Food Sci. Nutr. 28(3):619-24 [Korean with English summary]. <http://www.dbpia.co.kr/Journal/ArticleDetail/480942>.

Nakakuki T. 2002. Present status and future of functional oligosaccharide development in Japan. Pure Appl. Chem., Vol. 74, No. 7, 1245-1251.

Nakakuki T. 2003. Development of functional oligosaccharides in Japan. Trends in Glycoscience and Glycotechnology 15(82):62-63.
https://www.jstage.jst.go.jp/article/tigg1989/15/82/15_82_57/_pdf.

Noguchi, 2005. Japan Market Development Reports. J. Food Business Line. Vol.12, July15-Aug 15, 4. <http://apps.fas.usda.gov/gainfiles/200509/146131017.doc>.

Oku T., and Nakamura S. 2003. Comparison of digestibility and breath hydrogen gas excretion of fructo-oligosaccharide, galactosyl-sucrose and isomalto-oligosaccharide in healthy human subjects. European Journal of Clinical Nutrition, 57, 1150-1156.
<http://www.nature.com/ejcn/journal/v57/n9/pdf/1601666a.pdf>.

Oku T., and Nakamura S. 2002. Digestion, absorption, fermentation, and metabolism of functional sugar substitutes and their available energy. *Pure Appl. Chem.* 74(7):1253-1261.

Sake World, Sake consumption in Japan: dismal days. #90. May 2007.

http://sake-world.com/html/sw-2007_4.html.

Topping DL. And Clifton PM. 2001. Short-chain fatty acids and human colonic function-roles of resistant starch and nonstarch polysaccharides. *Physiological Reviews.* 81(3):1032-1064.

Tungland B.C.; Meyer D. 2002. Nondigestible oligo-and polysaccharides (dietary fiber): Their physiology and role in human health and food. *Compr. Rev. Food Sci. Food Safety* 3:73-92.

Wang HF., Lim PS., Kao MD., Chan EC., Lin LC., Wang NP. 2001. Use of isomalto-oligosaccharide in the treatment of lipid profiles and constipation in hemodialysis patients. *J. Ren. Nutr.* 11(2):73-9.

LIST OF TABLES

Table 1	Commercially Available NDOs with Bifidogenic Functions	7
Table 2	Chemical Description of the Saccharides in BLB [®] IMO Products	8
Table 3	Distribution of Major Components of BLB [®] IMO products (%)	11
Table 4	Organoleptic Specifications of BLB [®] IMO Products	15
Table 5	Physical and Chemical Specifications for BLB [®] IMO Products	15
Table 6	Contamination Specifications for BLB [®] IMO Products	16
Table 7	Microbiological Specifications for BLB [®] IMO Products	17
Table 8	Certificate of Analysis for BLB [®] IMO-90 Syrup	17
Table 9	Certificate of Analysis for BLB [®] IMO-90 Powder	18
Table 10	Summary of Conditions of Intended Uses of BLB [®] IMO Products in Foods	19
Table 11	History of Traditional Exposure in Japan	20
Table 12	Demand for Oligosaccharides in Japan, 2002	21
Table 13	Saccharide Compositions of Two Types of Isomaltooligosaccharides (IMO)	26
Table 14	Summary of Oral Subchronic and Chronic Animal Toxicity Studies with Isomalto-oligosaccharide (IMO) Products	27
Table 15	Summary of Human Tolerance Studies with IMO Products	32
Table 16	Composition of Isomalto-oligosaccharides (IMO) Products ¹ Tested in the Published Studies	39

LIST OF FIGURES

Figure 1	Chemical Structures of the Mono-, Di-, and Oligosaccharides (DP3 to DP5) Identified in BLB [®] IMO Products	10
Figure 2	Schematic Chart of Manufacturing Process of BLB [®] IMO Products	12

APPENDIX

- Appendix A1 Analytical Results for BLB[®] IMO-90 Syrup (Lot No. 14070533)
- Appendix A2 Analytical Results for BLB[®] IMO-90 Syrup (Lot No. 14091132)
- Appendix A3 Analytical Results for BLB[®] IMO-90 Syrup (Lot No. 14092633)
- Appendix B1 Analytical Results for Lot BLB[®] IMO-90 Powder (Lot No. 14071631)
- Appendix B2 Analytical Results for Lot BLB[®] IMO-90 Powder (Lot No. 14081032)
- Appendix B3 Analytical Results for Lot BLB[®] IMO-90 Powder (Lot No. 14090231)
- Appendix C1 Microbiological Analytical Results for BLB[®] IMO-90 Syrup (Lot No. 14070533)
- Appendix C2 Microbiological Analytical Results for BLB[®] IMO-90 Syrup (Lot No. 14091132)
- Appendix C3 Microbiological Analytical Results for BLB[®] IMO-90 Syrup (Lot No. 14092633)
- Appendix D1 Microbiological Analytical Results for BLB[®] IMO-90 Powder (Lot No. 14071631)
- Appendix D2 Microbiological Analytical Results for BLB[®] IMO-90 Powder (Lot No. 14081032)
- Appendix D3 Microbiological Analytical Results for BLB[®] IMO-90 Powder (Lot No. 14090231)
- Appendix E GB 8885-2008 Edible corn starch (EN)
- Appendix F GB 8275-2009 Alpha-amylase preparation (EN)
- Appendix G QB 2526–2001 Fungi alpha-amylase (EN)
- Appendix H GB 25594–2010 Enzyme preparations used in food industry (EN)
- Appendix I QB 2525-2001 Alpha-glucosidase (EN)
- Appendix J GB 1886-2008 Sodium carbonate (EN)
- Appendix K GB 1897-2008 Hydrochloric acid (EN)
- Appendix L GB 5175-2008 Sodium hydroxide (EN)
- Appendix M GB 29215–2012 Activated Charcoal (EN)
- Appendix N GB 16579–2013 D001 Cation exchange resins (EN)
- Appendix O HG 2165-91 D301 Anion exchange resins (EN)
- Appendix P GB/T 20881-2007 IMO (EN)

ATTACHMENT

- Attachment 1 Vita of Dr. Chi-Tang Ho
- Attachment 2 Vita of Dr. Xiuling Lu
- Attachment 3 Vita of Dr. Shiru Jia

1. INTRODUCTION

The undersigned, an independent panel of recognized experts (Expert Panel)¹, qualified by their scientific training and relevant national and international experience to evaluate the safety of food and food ingredients, was convened by Smith Business Services, LLC., at the request of Baolingbao Biotechnology Inc. (BLB), to determine the Generally Recognized As Safe (GRAS) status of isomalto-oligosaccharides preparation (BLB[®] IMOs) as a food ingredient [21 CFR 170.3(o)(20)] in selected food products [baked goods and baking mixes, beverages and beverage bases, breakfast cereals, chewing gum, dairy product analogs, egg products, fats and oils, frozen dairy desserts & mixes, gravies and sauces, hard candy, infant and toddler food (not include infant formula), milk products, processed fruits and fruit juices, soft candy, soups and soup mixes] at use levels of 1.5 to 15 g/serving (reference amounts customarily consumed eating occasion, 21 CFR 101.12).

Isomalto-oligosaccharides (IMO) are a mixture of glucose oligomers with α -(1,6)-glucose linkages such as isomaltose, panose, isomaltotriose, isomaltopentose and higher branched oligosaccharides (Kaneko *et al.*, 1995; Ketabi, 2001a; Nakakuki, 2002). IMO have been ingested by human for hundreds of years as they are naturally occurred in honey, and fermented foods, such as miso, sake and soy sauce (BioNeutra, 2008). As a food ingredient, IMO are not only widely used in food industry, and but also exhibit certain physiological functions that may have important implications in human health (Tungland & Meyer, 2002; Nakakuki, 2002).

IMO are only partially digested and undigested portion is fermented in the colon (Kaneko *et al.*, 1992; Kaneko, 1995; Ketabi *et al.*, 2011a; Ketabi, 2011b; Kohmoto *et al.*, 1992). The caloric content of a commercial IMO preparation was about 75% when compared to maltose (Kohmoto, *et al.*, 1992). At high doses, non-digestible oligosaccharides (NDO) and polysaccharides usually have a laxative effect. However, IMO are generally tolerated at high dosage compared to other NDO (Kaneko, *et al.*, 1994).

A comprehensive search of the scientific literature for safety and toxicity information on isomalto-oligosaccharides was conducted both by Smith Business Services, LLC and the Expert Panel members. The Expert Panel members independently and critically evaluated the materials and other information deemed appropriate or necessary. Baolingbao Biotechnology Inc. assures that all unpublished information in its possession and relevant to the subject of this determination has been provided to Smith Business Services, LLC and has been

¹ See Attachments (curriculum vitas) for the members of the Expert Panel documenting their expertise of scientific training and relevant experience to evaluate the safety of food.

summarized in this GRAS monograph. Following an independent, critical evaluation, the Expert Panel conferred and unanimously agrees to the decision that under the conditions of intended use in foods described herein, meeting appropriate food-grade specifications, and manufactured and used in accordance with current good manufacturing practice (cGMP), BLB[®] IMO is GRAS based on scientific procedures. A summary of the basis for the Panel's conclusion is described below.

2. DETAIL DESCRIPTIONS AND IDENTITY OF THE SUBSTANCE

2.1. Background

Carbohydrates are usually classified according to their molecular size or degree of polymerization (DP), which is the number of monosaccharide units combined, into monosaccharides, oligosaccharides or polysaccharides. Structurally, oligosaccharides are composed of 2–10 monosaccharide residues linked by glycosidic bonds that are readily hydrolyzed to their constituent monosaccharides either by acids or by specific enzymes (Nakakuki, 2002). However, also there are cases where the DP rises up to 60, like inulin (Roberfroid, 2007a), or down to 2, like lactulose (Conway, 2001; Mussatto and Mancilha, 2007). Consequently, oligosaccharides are low molecular weight carbohydrates.

Carbohydrates also can be classified as digestible or non-digestible based on the physiological properties. The main categories of non-digestible oligosaccharides (NDOs) presently available or in development as food ingredients include carbohydrates in which the monosaccharide unit is fructose, galactose, glucose and/or xylose (Mussatto and Mancilha, 2007). Most of the commercial non-digestible oligosaccharides products are mixture of oligosaccharides with variable DP, including the parent polysaccharides, and/or di- and mono-saccharides (Crittenden & Playne, 1996; Chen, 2008).

NDOs are the oligosaccharides that resist hydrolysis by human salivary and gastrointestinal digestive enzymes (Chen, 2008). Since these compounds present important physicochemical and physiological characteristics beneficial to food industry and the health of consumers, their use as food ingredients has strongly increased in recent years (Mussatto and Mancilha, 2007). Such characteristics include non-cariogenicity, a low calorific value and the ability to stimulate the growth of beneficial bacteria in the colon; they are also associated with a lower risk of infection and diarrhea, and an improvement of the immune system response (Mussatto and Mancilha, 2007). Moreover, due to the decrease of the intestinal pH caused by their fermentation, NDOs provoke a reduction of the pathogens flora, an increase of bifidobacteria population, and an increase of the availability of minerals (Mussatto and Mancilha, 2007). In the food industry, NDOs have potential to improve the quality of many foods, including

enhancing food flavor, being as bulking agents, increasing viscosity that leads to improve food body and mouthfeel, and improving other physicochemical properties of foods (Crittenden & Playne, 1996; Rivero-Urgell & Santamaria-Orleans, 2001).

Table 1 presents 13 classes of NDOs that present bifidogenic functions, and are commercially produced (Sako, *et al.*, 1999).

Table 1 Commercially Available NDOs with Bifidogenic Functions (Sako, *et al.*, 1999)

Compound	Molecular structure ¹
Cyclodextrins	(Gu) _n
Fructooligosaccharides	(Fr) _n -Gu
Galactooligosaccharides	(Ga) _n -Gu
Gentiooligosaccharides	(Gu) _n
Glycosylsucrose	(Gu) _n -Fr
Isomaltoligosaccharides	(Gu) _n
Isomaltulose (or palatinose)	(Gu-Fr) _n
Lactosucrose	Ga-Gu-Fr
Lactulose	Ga-Fr
Maltooligosaccharides	(Gu) _n
Raffinose	Ga-Gu-Fr
Soybean oligosaccharides	(Ga) _n -Gu-Fr
Xylooligosaccharides	(Xy) _n

¹ Ga–galactose; Gu–glucose; Fr–fructose; Xy–xylose

Isomalto-oligosaccharides (IMO) are considered as non-digestible oligosaccharides (Ketabi, 2011b). Commercially available IMO are a mixture of glucose oligomers with α -(1,6)-glucose linkages such as isomaltose, panose, isomaltotriose, isomaltopentose and higher branched oligosaccharides (Kaneko *et al.*, 1995; Ketabi, 2001a; Nakakuki, 2002). As food ingredients, IMO, as well as other oligosaccharides, have great potential to improve the quality and the physicochemical properties of many foods (due to its mild sweetness, relatively low viscosity, and high moisture retaining properties, etc.) (Mussatto and Mancilha, 2007), meanwhile, they may provide positive physiological effects on human, which including the improvement of intestinal microflora based on the selective proliferation of bifidobacteria and lactobocilli, stimulation of mineral absorption, and the improvement of both cholesterol and blood glucose level, for human (Nakakuki. 2002; Mussatto and Mancilha, 2007).

2.2. Composition of BLB[®] IMO Product

Isomalto-oligosaccharides are glucose oligomers with α -D-(1,6) and α -(1,4)-linkages, including isomaltose, panose, isomaltotriose, isomaltopentose and higher branched oligosaccharides (Kaneko *et al.*, 1995; Ketabi, 2001a; Nakakuki, 2002). Human intestinal enzymes readily digest α -(1,4)-glycosidic bonds, but α -D-(1,6)-glycosidic bonds, particular those linking longer polymers, are not easily hydrolyzed as they pass through the human gastrointestinal tract (BioNeutra, 2008). The majority of oligosaccharides found in BLB[®] IMO consist of 3 to 7 monosaccharide units linked together; however, disaccharides, as well as longer oligosaccharides (up to 9 units) are also present. The disaccharide fraction of BLB[®] IMO consists of α -(1,4)-glycosidic bond linked maltose and α -D-(1,6)- glycosidic bond linked isomaltose, while maltotriose, panose, and isomaltotriose make up the trisaccharide fraction. Maltotetraose, maltopentaose, maltohexaose, maltoheptaose, and small amounts of oligomers with 8 or higher degrees of polymerization (DP) comprise the remaining oligomers in the product. The chemical names, CAS numbers and empirical formulas of some of the lower weight saccharides identified in the IMO products are summarized in Table 2. The chemical structures for the major constituents in BLB[®] IMO are showed in Figure 1.

Table 2 Chemical Description of the Saccharides in BLB[®] IMO Products

Common Name	CAS No.	Empirical Formula	Chemical Name
<i>Monosaccharides (DP¹)</i>			
Glucose	50-99-7	C ₆ H ₁₂ O ₆	D-Glucose
<i>Disaccharides (DP²)</i>			
Maltose	69-79-4	C ₁₂ H ₂₂ O ₁₁	4-O- α -D-glucopyranosyl-D-glucose
Isomaltose	488-40-1	C ₁₂ H ₂₂ O ₁₁	6-O- α -D-glucopyranosyl-D-glucose
<i>Trisaccharides (DP³)</i>			
Maltotriose	1109-28-0	C ₁₈ H ₃₂ O ₁₆	O- α -D-glucopyranosyl-(1,4)- O- α -D-glucopyranosyl-(1,4)-D-glucose
Panose	33401-87-5	C ₁₈ H ₃₂ O ₁₆	O- α -D-glucopyranosyl-(1,6)- O- α -D-glucopyranosyl-(1,4)-D-glucose
Isomaltotriose	3371-50-4	C ₁₈ H ₃₂ O ₁₆	O- α -D-glucopyranosyl-(1,6)- O- α -D-glucopyranosyl-(1,6)-D-glucose
<i>Oligo- and Polysaccharides (DP⁴ to DP⁹)</i>			
Isomaltotetraose (DP ⁴)	35997-20-7	C ₂₄ H ₄₂ O ₂₁	O- α -D-glucopyranosyl-(1,6)- O- α -D-glucopyranosyl-(1,6)- O- α -D-glucopyranosyl-(1,6)-D-glucose
Isomaltopentaose (DP ⁵)	6082-32-2	C ₃₀ H ₅₂ O ₂₆	O- α -D-glucopyranosyl-(1,6)- O- α -D-glucopyranosyl-(1,6)- O- α -D-glucopyranosyl-(1,6)- O- α -D-glucopyranosyl-(1,6)-D-glucose

Table 2 Chemical Description of the Saccharides in BLB[®] IMO Products (Continued)

Isomaltohexaose (DP6)	6175-02-6	C ₃₆ H ₆₂ O ₃₁	O- α -D-glucopyranosyl-(1,6)- O- α -D-glucopyranosyl-(1,6)- O- α -D-glucopyranosyl-(1,6)- O- α -D-glucopyranosyl-(1,6)- O- α -D-glucopyranosyl-(1,6)-D-glucose
Isomaltoheptaose (DP7)	6513-12-8	C ₄₂ H ₇₂ O ₃₆	O- α -D-glucopyranosyl-(1,6)- O- α -D-glucopyranosyl-(1,6)- O- α -D-glucopyranosyl-(1,6)- O- α -D-glucopyranosyl-(1,6)- O- α -D-glucopyranosyl-(1,6)- O- α -D-glucopyranosyl-(1,6)-D-glucose
Isomaltooctaose (DP8)	6156-84-9	C ₄₈ H ₈₂ O ₄₁	O- α -D-glucopyranosyl-(1,6)- O- α -D-glucopyranosyl-(1,6)- O- α -D-glucopyranosyl-(1,6)- O- α -D-glucopyranosyl-(1,6)- O- α -D-glucopyranosyl-(1,6)- O- α -D-glucopyranosyl-(1,6)- O- α -D-glucopyranosyl-(1,6)- D-glucose
Isomaltononaose (DP9)	6471-60-9	C ₅₄ H ₉₂ O ₄₆	O- α -D-glucopyranosyl-(1,6)- O- α -D-glucopyranosyl-(1,6)- O- α -D-glucopyranosyl-(1,6)- O- α -D-glucopyranosyl-(1,6)- O- α -D-glucopyranosyl-(1,6)- O- α -D-glucopyranosyl-(1,6)- O- α -D-glucopyranosyl-(1,6)- O- α -D-glucopyranosyl-(1,6)- D-glucose

¹ DP – Degree of polymerization

Excepted from and modified to GRAS Notice for Vitasugar[™] GRN (FDA GRN 2009).

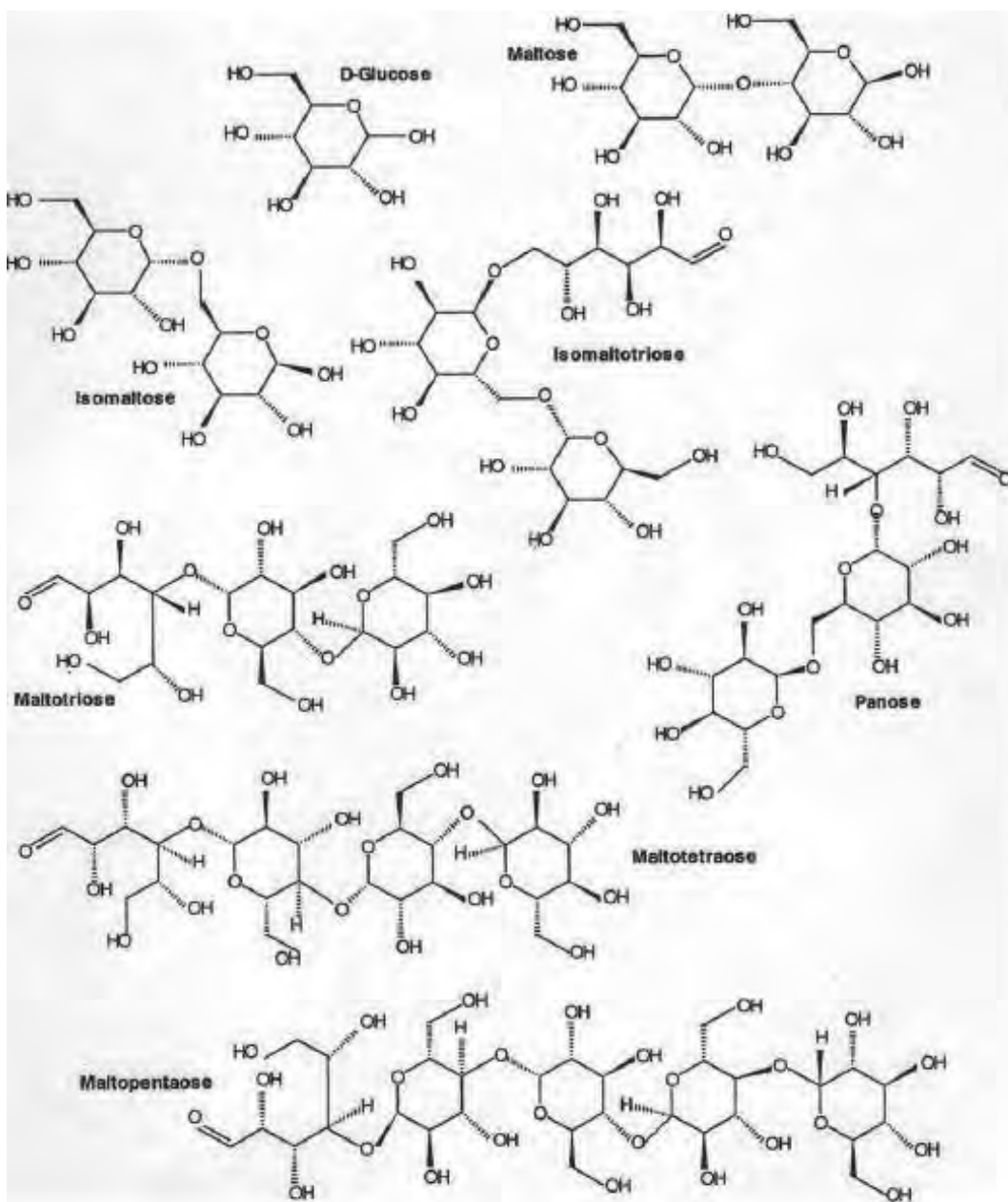

Figure 1 Chemical Structures of the Mono-, Di-, and Oligosaccharides (DP3 to DP5) Identified in BLB[®] IMO Products
Excerpted from FDA GRN (2009)

The compositional analysis of BLB[®] IMO products presented that the syrup and powder formulations contain less than 1% glucose both in IMO syrup and powder; contain 33 and 35% smaller saccharides (fewer than 3 glucose unit), respectively; oligosaccharides with DP3 take up approximately 22 and 20%, respectively. Oligomers (4 or more glucose units) account

for approximately 44%, both in IMO syrup and powder. The major components of BLB[®] IMO products are shown in Table 3 (see Appendix A1-A3 and Appendix B1-B3).

Table 3 Distribution of Major Components of BLB[®] IMO products (%)

Product Type	Lot No. ¹	Glu	M	IsoM	Mtri	P	IsoMtri	DP4 & Higher	IMO
IMO Syrup	1	0.32	7.27	27.16	1.5	10.14	8.8	44.82	90.91
	2	0.35	7.42	24.93	2	11.08	10.08	44.14	90.23
	3	0.39	8.28	24.22	1.31	12.09	9.7	44.01	90.02
Average		0.35	7.66	25.44	1.60	11.10	9.53	44.32	90.39
IMO Powder	4	0.97	6.92	27.84	1.36	9.9	8.07	44.94	90.75
	5	0.95	8	26.78	1.01	10.52	8.97	43.77	90.04
	6	0.94	8.07	27.64	0.97	9.75	8.22	44.41	90.02
Average		0.95	7.66	27.42	1.11	10.06	8.42	44.37	90.27

¹ IMO Syrup Lot No.: 1-14070533; 2-14091132; 3-14092633;
 IMO Powder Lot No.: 4-14071631; 5-14081032; 6-14090231
 Glu–Glucose; M–Maltose; IsoM–Isomaltose; Mtri–Maltotriose; P–Panose; DP4 & Higher–Tetrasaccharides or higher; IMO–Isomaltooligosaccharides; DP–Degree of polymerization

2.3. Manufacturing Process

BLB[®] IMO products are produced, in accordance with current good manufacturing practice (cGMP), from corn starch *via* highly controlled enzyme-hydrolyzed process that converts the starch molecules into isomalto-oligosaccharides mixture (BLB[®] IMO). All starting materials are appropriate for use in food and meet the specifications of the China National Standards.

A starting starch is mixed with water to prepare starch slurry to which salt and water (adjust pH), and α -amylase of bacterial origin from *Bacillus licheniformis* are added to prepare the liquefaction of the starch. The starch particles are broken and partially hydrolyzed *via* high temperature and enzyme in liquefaction. In saccharification process, α -amylase of fungal origin from *Aspergillus oryzae* further hydrolyzes dextrin into maltose and malto-oligosaccharides, and α -glucosidase from *Aspergillus niger* is used to convert α -(1,4)-linkages (maltose and malto-oligosaccharides) to α -(1,6)-linkages that comprise the isomalto units, including isomaltose, panose, isomaltotriose, isomaltotetraose, etc. The temperature of the mixture is increased to at least 90°C to terminate the enzymatic activity. Several down-stream steps, including decolonization, filtration, ion exchange and chromatographic separation, etc., are performed in the manufacturing process of BLB[®] IMO to minimize the potential residues of biocatalysts or other processing aids used during the production. The mixture is then concentrated to syrup type final products. The concentrate is spray-dried to form the powder

type final products. The schematic chart of the manufacturing process of BLB[®] IMO is provided in Figure 2.

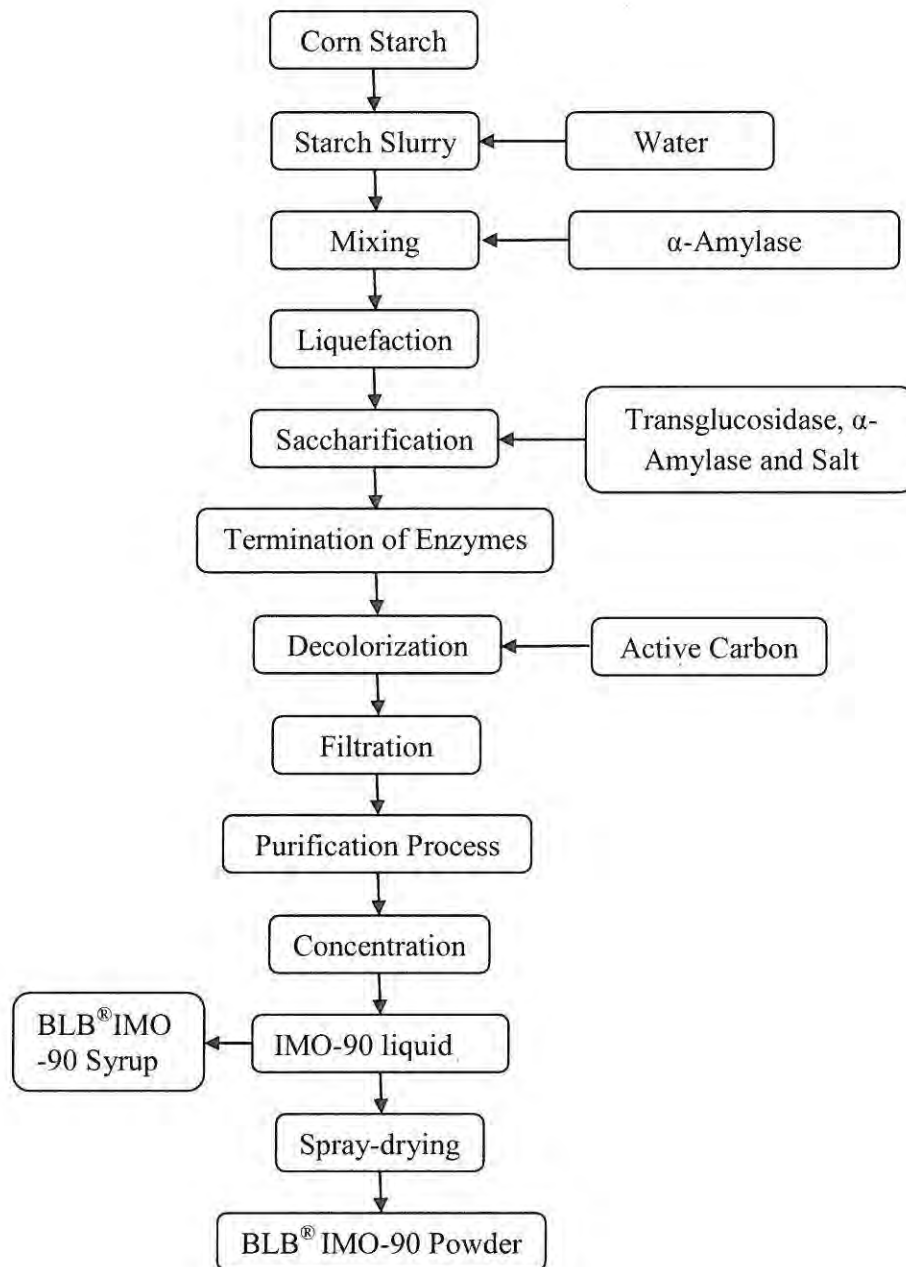

Figure 2 Schematic Chart of Manufacturing Process of BLB[®] IMO Products

2.4. Quality Controls

The entire manufacturing process is accordance the requirements of cGMP. All water used in the production is treated by mechanical filtrations, and reverse osmosis membrane filtration. The CIP cleaning system covers all production equipment, pipelines and containers/reactors to assure effective cleaning in timely manner, and to assure the safety and stability of the final products. All starting materials, enzymes, chemicals and reagents and processing aids are appropriate for use in food and meet the related specifications of the China National Standards (GB²).

2.4.1. Corn Starch as the Starting Material

Unmodified food-grade corn starch meets the standards of edible corn starch of China's national standard GB/T 8885-2008 (see Appendix E), and is used as the starting material in the production of BLB[®] IMO products.

2.4.2. Enzymes, Chemicals/Reagents and Processing Aids

Enzymes

Heat-resisting α -Amylase is used in liquefaction of corn starch during IMO production. As a commercial product from *Bacillus licheniformis*, it is compliance to the specifications of the China National Standards of α -Amylase preparation GB 8275-2009 (see Appendix F) and GB 25594-2010 (see Appendix H).

Fungal α -Amylase is a fungal origin (*Aspergillus oryzae*) enzyme that is used in the saccharification process. It is compliant to the specifications of α -Amylase preparation QB³ 2526-2001 (see Appendix G) and GB 25594-2010 (see Appendix H).

Transglucosidase or α -glucosidase is produced from *Aspergillus niger*, and used to convert α -(1,4)-linkages to α -(1,6)-linkages of saccharides. It is compliant to the specifications of Transglucosidase preparation QB 2525-2001 (see Appendix I) and GB 25594-2010 (see Appendix H).

Sodium Carbonate

Sodium carbonate (Na₂CO₃) ($\geq 99.2\%$ purity, dry basis) is used to control pH of the mixture during the manufacturing process of BLB[®] IMO products, and it is compliance to GB 1886-2008) (see Appendix J). It is affirmed by FDA as a GRAS substance for use as a pH adjusting agent, and its use level not exceed current good manufacturing practice (21 CFR §184.1742).

² GB – National Standard of the People's Republic of China

³ QB – Light Industry Standard of the People's Republic of China

Hydrochloric Acid

Hydrochloric acid (HCl) ($\geq 31\%$ w/w) is used as a pH adjusting agent during the manufacture of BLB[®] IMO products. It is compliant to the specifications of GB 1897-2008 (see Appendix K). Hydrochloric acid is also affirmed by FDA as a GRAS substance for use as a buffer and neutralizing agent in accordance with good manufacturing practice (21 CFR §182.1057).

Sodium Hydroxide

Sodium hydroxide (NaOH) (98.0 – 100.5% purity, w/w), is used as a pH adjusting agent during the production of the BLB[®] IMO products, and consistent with the China National Standards of sodium hydroxide GB 5175-2008 (see Appendix L). It is affirmed by FDA as a GRAS substance for use in foods as a pH control agent at levels not to exceed current good manufacturing practice (21 CFR §184.1763).

Activated Carbon Powder

Activated carbon powder is plant origin and used during the manufacturing process as a purification agent and decolorizing agent. It is consistent with the China National Standards of activated carbon powder of GB 29215-2012 (see Appendix M).

Ion-exchange Resins

Ion-exchange resins are prepared in appropriate physical form and consist of sulfonated copolymers of styrene, and are permitted for use as ion exchange resins for the purification of food (21 CFR §173.25). The ion-exchange resins are used during the purification process to remove various impurities from the final IMO products. D001 macroporous strongly acidic styrene type is a cation exchange resin that contains sodium sulfonate, and consistence to GB/T 16579–2013 (see Appendix N). D301 macroporous weakly basic styrene type is an anion exchange resin mainly containing tertiary amino group, and compliance to HB⁴ 2165–91 (see Appendix O).

2.5. Stability of BLB[®] IMO products

IMO is very stable under acidic or alkaline conditions (pH 2.0 to 10) (Bionutra, 2008). In a study performed by BioNeutra, the IMO molecules were found to be >99% stable under high acidic or alkaline conditions, particularly at pH 2.0 in terms of breakdown of glucose molecules when incubated for up to one year at three given storage temperatures: room temperature (25°C), at refrigerator temperature (4°C), and at high temperature (45°C) (Bionutra, 2008).

⁴ HB – Chemical Industry Standard of the Pleople’s Republic of China

The stability of BLB[®] IMO products (IMO-90 powder) was studied using HPLC method to determine the residual rate of IMO under different conditions. Under neutral condition (pH 7.0), IMO was heat treated at 135°C, 121°C and 85°C for 25 sec, 25 min and 30 min, respectively, the results revealed that IMO was very stable. Under acidic conditions of pH 4.2, IMO was very stable at temperatures of 135°C, 121°C and 85°C for 25 sec, 25 min and 30 min, respectively. IMO was stable at 135°C and 85°C for 25 sec and 30 min, respectively in alkaline condition (pH 7.8). However, 89% of IMO was reserved after heated at 121°C for 25 min in the condition of pH 7.8 (Duan. *et al.* 2009).

2.6. Specifications of BLB[®] IMO Products

The organoleptic specification and the chemical, physical and microbiological specifications for BLB[®] IMO products (syrup and powder) are presented in Table 4, Table 5, Table 6, and Table 7, respectively. BLB[®] IMO products are consistent with the China National Standard of Isomaltooligosaccharides specified in GB/T 20881-2007 (see Appendix P).

Table 4 Organoleptic Specifications of BLB[®] IMO Products

Items	Specifications		Analytical Methods
	BLB [®] IMO Syrup	BLB [®] IMO Powder	
Color	Colorless or Pale yellow and transparent viscous liquid	White and amorphous powder	Visual
Taste	Light and gentle sweetness	Light and gentle sweetness	—
Odor	Odorless	Odorless	—
Impurity	No visible impurities	No visible impurities	Visual

Table 5 Physical and Chemical Specifications for BLB[®] IMO Products

Items	Specifications		Analytical Methods
	BLB [®] IMO Syrup	BLB [®] IMO Powder	
IMO (% dry basis)	≥90	≥90	HPLC analysis GB/T ² 20881-2007
IG ₂ +P+IG ₃ ¹ (% Dry basis)	≥45	≥45	HPLC analysis GB20881-2007
Dried Solid (%)	≥75	N/A	Abbe's refractometer GB/T20885-2007
Moisture (%)	N/A	≤5	Direct Drying GB/T 20884-2007
pH		4.0 – 6.0	GB/T 20885-2007

Table 5 Physical and Chemical Specifications for BLB[®] IMO Products (Continued)

Solubility (water) (%)	N/A	≥99	Gravimeter GB/T 20884-2007
Transmittance (%)	≥95	N/A	Spectrophotometer GB/T 20885-2007
Sulphated Ash		≤0.3	GB/T 20885-2007

¹ IG₂–Isomaltose; P–Panose; IG₃–Isomaltotriose² GB – China National Standards

Table 6 Contaminations

Items	Specifications		Analytical Methods
	Syrup	Powder	
Contamination			
Arsenic (As) (mg/kg)		≤0.5	Hydride generation atomic fluorescence spectrum GB /T 5009.11-2003
Lead (Pb) (mg/kg)		≤0.5	graphite furnace atomic absorption spectrometry GB 5009.12-2010
Sulfur Dioxide (g/kg)		≤0.04	Distillation GB/T 5009.34-2003

Table 7 Microbiological Specifications for BLB[®] IMO Products

Items	Specifications		Analytical Methods
	Syrup	Powder	
Microbiological Specifications			
Total Aerobic Plate Count (CFU/g)		≤3,000	Plate count GB 4789.2-2010
<i>Escherichia Coli</i> (MPN/g)		≤0.3	MPN count GB 4789.2-2010
<i>Salmonella</i> (CFU/g)		Absent	GB 4789.2-2010

Analysis of non-consecutive representative lots demonstrated compliance with the specifications of the final products (syrup: BLB[®] IMO-90 and powder: BLB[®] IMO-90). The

analytical results for the non-consecutive lots provided in the Table 8 and Table 9, respectively.

Table 8 Certificate of Analysis for BLB[®] IMO-90 Syrup (see Appendix A1-A3; C1-C3)

Item	Specification	Batch No.		
		14070533	14091132	14092633
Organoleptic	Colorless or pale yellow; transparent viscous liquid. Light and gentle sweetness. Odorless, no visible impurities.	Colorless or pale yellow; transparent viscous liquid. Light and gentle sweetness. Odorless, no visible impurities.	Colorless or pale yellow; transparent viscous liquid. Light and gentle sweetness. Odorless, no visible impurities.	Colorless or pale yellow; transparent viscous liquid. Light and gentle sweetness. Odorless, no visible impurities.
IMO (% , dry basis)	≥90	90.91	90.23	90.02
IG ₂ +P+IG ₃ (% , dry basis)	≥45	46.09	46.09	46.01
Dried Solid (%)	≥75	75.54	75.42	75.35
pH	4.0 – 6.0	4.7	4.6	5.0
Transmittance (%)	≥95	99	99	99
Sulphated Ash (%)	≤0.3	<0.085	<0.081	<0.069
Sulfur Dioxide (g/kg)	≤0.04	0.00518	0.00650	0.00712
Lead (mg/kg)	≤0.5	Absent	Absent	Absent
Arsenic (mg/kg)	≤0.5	Absent	Absent	Absent
Total Aerobic Plate Count (CFU/g)	≤3,000	<10	<10	<10
<i>Escherichia Coli</i> (MPN/g)	≤0.3	<0.3	<0.3	<0.3
<i>Salmonella</i> (CFU/g)	Absent	Absent	Absent	Absent

2.7. Self-limiting Levels of Use

The use of BLB[®] IMO in food is mainly limited by the desired sweetness intended for a particular food or beverage products. Therefore, the use of BLB[®] IMO in foods at upper use levels is largely self-limiting based on its organoleptic properties.

Table 9 Certificate of Analysis for BLB[®] IMO-90 Powder (see Appendix B1-B3; D1-D3)

Item	Specification	Batch No.		
		14071631	14081032	14090231
Organoleptic	White and amorphous powder; light and gentle sweetness; odorless; and no visible impurities.	White and amorphous powder; light and gentle sweetness; odorless; and no visible impurities.	White and amorphous powder; light and gentle sweetness; odorless; and no visible impurities.	White and amorphous powder; light and gentle sweetness; odorless; and no visible impurities.
IMO (% dry basis)	≥90	90.75	90.04	90.02
IG ₂ +P+IG ₃ (% dry basis)	≥45	45.8	46.27	45.61
Moisture (%)	≤5	4.3	4.0	4.4
pH	4.0 – 6.0	4.7	4.6	4.7
Solubility (%)	≥99	99.8	99.8	99.7
Sulphated Ash (%)	≤0.3	<0.085	<0.078	<0.084
Sulfur Dioxide (g/kg)	≤0.04	0.00641	0.00579	0.00708
Lead (mg/kg)	≤0.5	Absent	Absent	Absent
Arsenic (mg/kg)	≤0.5	Absent	Absent	Absent
Total Aerobic Plate Count (CFU/g)	≤3,000	<10	<10	<10
<i>Escherichia Coli</i> (MPN/g)	≤0.3	<0.3	<0.3	<0.3
<i>Salmonella</i> (CFU/g)	Absent	Absent	Absent	Absent

2.8. Intended Uses of BLB[®] IMO Products

Isomalto-oligosaccharides are a mixture of glucose oligomers with α -(1,6)-glucosidic linkages, such as isomaltose, panose, isomaltotriose, isomaltotetrose, isomaltopentose, and higher branched oligosaccharides (Kaneko *et al.*, 1995; Ketabi, 2001a; Nakakuki, 2002). They are naturally occurred components of the human diet, and have been ingested by humans for hundreds of years as they are naturally found in honey, miso, sake and soy sauce (BioNeutra, 2008).

BLB[®] IMO has a sweetness of 40 to 60% relative to that of sucrose. As an alternative sweetener, BLB[®] IMO is intended to be used for partial replacement of other currently available sweeteners at levels up to 15 g per serving in a number of conventional foods [Reference Amounts Customarily Consumed per Eating Occasion (RACC) (U.S. FDA, 2007c)]. The conditions of intended use and levels are summarized in Table 10 below.

Table 10 Summary of Conditions of Intended Uses of BLB[®] IMO Products in Foods

Food Category	Serving Size (g) ¹	Maximum Use Level (%)	IMO Amount per Serving (g)
Baked Goods and Baking Mixes	60	25	15
Beverages and Beverage Bases	240	5	12
Breakfast Cereals	50	20	10
Condiments and Relishes	23	20	5
Dairy Product Analogs	240	5	12
Mayonnaise & Mayonnaise –type Dressings	23	30	7
Salad Dressings	30	30	9
Frozen Dairy Desserts and Mixes	100	10	10
Gelatins, Puddings, and Fillings	100	15	15
Gravies and Sauces	70	20	14
Hard Candies	10	100	10
Jams and Jellies	15	75	11
Milk and Milk Products	110	5	5.5
Nut Products	30	10	3
Processed Fruits and Fruit Juices	140	5	7
Snack Foods	30	5	1.5
Soft Candy	35	40	14
Sugar Substitutes	4	100	4
Sweet Sauces, Toppings and Syrups	30	50	15
Processed Vegetables and Vegetable Juices	100	15	15

¹Based on the Reference Amounts Customarily Consumed (RACC) Per Eating Occasion (21 CFR §101.12)(U.S. FDA, 2007a)

Adopted and modified from FDA GRN (2009)

3. EXPOSURE ESTIMATES AND DAILY INTAKE

3.1. Exposure Estimates

3.1.1. Natural Occurrence of IMO

BioNeutra Inc. (2008) indicated that isomalto-oligosaccharides have been ingested by humans for hundreds of years as they are naturally found in honey, miso, sake and soy sauce. Many of the natural products containing IMO have been traditionally consumed in Japan and other Asian countries for a long time. Table 11 shows the per capita consumption of IMO in Japan from three traditional food and beverage sources.

Table 11 History of Traditional Exposure in Japan (BioNeutra, 2008)

Product	Annual Consumption of Product	IMO in Product %	Approximate Annual per Capita consumption of IMO
Honey	300 g	1.0	3 g
Miso	4.6 kg	1.1	50 g
Sake	8 L	0.5	40 g

Miso is soybean combined with rice and other ingredients and aged in cedar vats for up to three years. Its predecessor was known as “hisio,” a seasoning made from fermenting soybeans, wheat, alcohol, salt and other ingredients. This fermented soybean paste was introduced into Japan around the 7th century.

Miso is often consumed daily in soups and used in sauces and marinades. Annual Miso production is about 600,000 MT per year in Japan (Noguchi, 2005). Given a population of 128.9 million, annual per capita consumption of Miso is thus estimated to be 4.6 kg.

Sake is a traditional Japanese alcoholic beverage made from rice. Annual per capita sake consumption has been declining in Japan (9.8 L in 1985; 8.1 L in 2001) and is now down to 6.9 L (Sake World, 2007).

Soy sauce is also reported to contain IMO (Tungland & Meyer, 2002). The data required to determine the per capita consumption of IMO from soy sauce in Japan was not available. Given the IMO consumption data from Table 10 above, along with the knowledge that soy sauce would also make a contribution, it would be reasonable to estimate the annual consumption of IMO in Japan from the traditional sources to be 100 grams.

3.1.2. Formulated Product Exposure

BioNeutra (2008) indicated that oligosaccharides, including IMO, are purchased by food

processors as ingredients for a variety of functional foods. Table 12 indicates the consumption of oligosaccharides in Japan (2002) based on the demand for the ingredients (Nakakuki, 2003).

Table 12 Demand for Oligosaccharides in Japan, 2002 (BioNeutra, 2008)

Oligosaccharide	Population (million)	Demand (MT)	Annual Per Capita consumption (g)
Malto-oligosaccharide	128.6	15,000	120
Isomalto-oligosaccharide	128.6	15,000	120
Fructo-oligosaccharide	128.6	3,500	30

3.2. Daily Intake Estimates

The daily intake estimates were based on the replacement for 2 servings per day of sucrose containing foods with BLB[®] IMO. Assuming daily consumption of 2 servings of food with added BLB[®] IMO at the proposed use-level as indicated in Table 9, so a daily intake estimate would be no more than 30 g/person/day.

4. BIOLOGICAL DATA

4.1. Regulatory Agency Reviews

Isomalto-oligosaccharide is permitted to use as food ingredient in countries, such as Japan and China for many years. The section reviews the regulatory status in USA, Canada, European Food Safety Authority (EFSA), Japan and China. A summary of the findings from the above countries is briefly present below.

4.1.1. FDA

In 2009, FDA issued the agent response letter for GRAS notice No. GRN 000246 regarding isomalto-oligosaccharides mixture (IMOM) manufactured by BioNeutra Inc. BioNeutra IMOM is a mixtures containing relatively short glucose oligomers with α -D-1,6 linkages, and has both syrup and powder formulations of IMOM. BioNeutra states that approximately 77 and 73 percent of the syrup and powder formulations, respectively, are composed of oligosaccharides between three and six degrees of polymerization. Mono- and disaccharides constitute (15 to 20 percent) and larger oligomers account for the remainder.

IMOM is used as an ingredient in a variety of foods, including meat products, at maximum levels ranging from 1.5 to 15 grams per serving (g/serving), and the estimated the intake of IMOM would be approximately 30 grams per person per day. This estimate is based on the assumed consumption of two servings of foods containing the highest use level identified (15 g/serving).

Based on the information provided by BioNeutra, as well as other information available to FDA, the agency has no questions at this time regarding BioNeutra's conclusion that IMOM is GRAS under the intended conditions of use (FDA GRN, 2009).

4.1.2. Canada

Health Canada evaluated the application for isomalto-oligosaccharide (IMO) as a novel food that was made by BioNeutra Inc., based on the comprehensive review of information submitted by the proponent according to Guidelines for the Safety Assessment of Novel Foods (Health Canada, 1994), and was communicated with a Food Directorate opinion that no objection is taken to the use of the subject product as food in Canada.

In December, 2009, Health Canada has notified BioNeutra Inc. that it has no objection to the use of IMO as a food ingredient. Isomalto-oligosaccharide is a food ingredient added to foods with a relative sweetness level equal to approximately 60% of sucrose.

IMO may be added to a variety of foods including, but not limited to, baked goods and baking mixes, beverages and beverage bases, condiments, salad dressings, frozen dairy desserts and mixes, gravies, sauces, hard and soft candies, jams, meat and nut products, processed fruits and vegetables, sugar substitutes, sweet sauces, and toppings. IMO is not permitted to be added to a food for which a standard exists in the *Food and Drug Regulations* unless the standard provides for the addition (Health Canada, 2009).

4.1.3. EFSA

In February 2009, UK Food Standards Agency (FSA) received the application from BioNeutra Inc. regarding placing isomalto-oligosaccharide on the EU market as a novel food ingredient. The application was evaluated by the Advisory Committee on Novel Foods and Processes (ACNFP), the independent Committee, and concluded that isomalto-oligosaccharide meets the criteria for acceptance as a novel food in its initial assessment report in December 2012 (FSA ACNFP 2013).

On the basis of the initial assessment report, it is established that BioNeutra's IMO powder and syrup complies with the criteria laid down in Article 3(1) of Regulation 258/97 when placed on the market in accordance with the conclusions of the initial assessment report. IMO may be added to the foods, including beverages (energy-reduced soft drinks, energy drinks, sport & isotonic drinks, fruit juices, processed vegetables and vegetable juices), cereal products (cereal bars, cookies, biscuits, breakfast cereal bars), sugar confectionery (hard candies/chocolate bars), and nutritionally complete and fortified foods (meal replacement bars and milk based meal replacement, at maximum use-level range from 5% to 97%. It also notes

that foods containing BioNeutra's IMO must be labeled as unsuitable for diabetics (FSA ACNFP, 2013).

4.1.4. Japan

Isomalto-oligosaccharide is considered as a starch-related oligosaccharide and was used as a prebiotic in healthy foods since the early 1980s to the late 1990s (Nakakuki T. 2003) in Japan. The Japanese government legislated for "Food for Specified Health Use (FOSHU)" taking the initiative in the world in 1991. In 2002, FOSHU increased the total to 324 items of which more than 50% incorporate oligosaccharides as the functional components (Nakakuki T. 2003). Isomalto-oligosaccharides (IMO) is listed in FOSHU for as a food to modify gastrointestinal conditions (Shigeharu Mori, 2009).

4.1.5. China

Isomalto-oligosaccharide is permitted to use in foods as an ingredient in China. Its national standard is GB/T 20881-2007 (see Appendix P) was established in 2007 in China. According to this standard, IMO is a mixture consisting of isomaltose, panose, isomaltraose, isomaltotetraose, as well as oligosaccharides with higher degree of polymerization.

IMO is classified as IMO-50 (IMO content $\geq 50\%$) and IMO-90 (IMO content $\geq 90\%$, dry base) based on the content of IMO, and has both powder and syrup types specified in GB/T 20881-2007 (see Appendix P).

4.2. Absorption, Distribution, Metabolism and Excretion

Isomalto-oligosaccharides are enzymatically manufactured from starch as a mixture of α -(1,6) and α -(1,4) linked glucosides. The composition of IMO is very complicated, because its degree of glucose polymerization ranges from di- to hexasaccharides, and glucosidic linkage varieties exist, for example, maltotriose, isomaltotriose and panose in trisaccharide components. Therefore, it is difficult to obtain the individual components of IMO in a definite amount (Keneko *et al.*, 1995).

The α -(1,6) linked oligomers can escape digestion in the mouth via salivary α -amylase (FDA 2009). The digestibility of IMO was measured in the *in vitro* digestion system containing artificial gastric acid, rat intestinal mucosa, or human salivary or hog pancreatic α -amylase. IMO was not hydrolyzed by the *in vitro* digestion system except in the model containing rat intestinal mucosa (Kaneko *et al.*, 1992). In 35-day rats test fed 20% IMO, the ratios of body weight gain/food intake of the test chows suggested that the energy available to rats in IMO was about 80% that of maltose and sucrose. The serum levels of triacylglycerol and nonesterified fatty acids were significantly lower in rats. These results were similar to those

obtained in rats fed chow containing fructooligosaccharide, which is nondigestible in the upper intestine and fermentable in the lower. The hydrolysis ratio of IMO by rat intestinal mucosa was much lower than that of maltose or isomaltose. The results suggested that IMO is partly hydrolyzed by the enzyme of intestinal mucosa, but that the residual undigested part passes down to the lower intestine (Kaneko *et al.*, 1992).

IMO are partially digested by enzymes of the small intestine (Kaneko *et al.*, 1992; Kaneko, 1995; Ketabi *et al.*, 2011a). The caloric content of a commercial IMO preparation was about 75% when compared with maltose (Kohmoto *et al.*, 1992). The intestinal surface membrane contains both α -(1,4)- and α -(1,6)-glucosidase activities that are probably responsible for α -limit dextrin (short linear and branched dextrin chains) hydrolysis (Gray *et al.*, 1979). α -Amylase is an endo-enzyme (or endo-glucosidase) that hydrolyzes the internal α -1,4 glycosidic linkages to form short linear (i.e., maltose, maltotriose, maltotetraose) and branched dextrin chains. These malto-oligosaccharides are further digested to yield 6^3 glucosylmaltotriose \rightarrow maltotriose \rightarrow maltose \rightarrow glucose by the mucosal α -glycosidases, sucrose-isomaltase (SI) and maltase-glucoamylase (MGAM) (Gray *et al.*, 1979; Cheng *et al.*, 2014). The experiments with human intestine revealed that sucrase-isomaltase is responsible for appreciable α -(1,4)-glucosidase activity and essentially all α -(1,6)-glucosidase activity (Conklin *et al.*, 1975). The sucrase moiety of the sucrase-isomaltase complex possesses α -(1,4)-glucosidase activity against maltose and maltotriose (Kerry *et al.*, 1967), and is incapable of cleaving the α -(1,6) linkage (Gray *et al.*, 1979). Its partner, isomaltase, appears to be responsible for most if not all intestinal α -(1,6)-glucosidase activity (Conklin *et al.*, 1975). Isomaltase has been shown to hydrolyze linear α -(1,6)-isomalto-oligosaccharides and presumably is capable of cleaving the α -(1,6)-branching links (Dahlqvist *et al.*, 1963). Glucose, produced as a result of the hydrolysis of the digestible saccharides, is absorbed and used by the body as a source of energy.

The undigested portion of IMO are considered as non-digestible oligosaccharides that escape digestion in the stomach and small intestine and reach the colon largely intact and fermented in the colon by microbiota (Ketabi, 2011b; Kohmoto *et al.*, 1992). Animal and human digestive systems accommodate numerous bacteria specialized in fermentation of non-digestible oligosaccharides (NDO) with various structures and degree of polymerization (Ketabi, 2011b). The microbiota of the mammalian intestine depends largely on dietary polysaccharides as energy sources. Most of these polymers are not degradable by the host, but herbivores can derive 70% of their energy intake from microbial breakdown — a classic example of mutualism. Moreover, dietary polysaccharides that reach the human large intestine have a major impact on gut microbial ecology and health. Insight into the molecular

mechanisms by which different gut bacteria use polysaccharides is, therefore, of fundamental importance. Genomic analyses of the gut microbiota could revolutionize our understanding of these mechanisms and provide new biotechnological tools for the conversion of polysaccharides, including lignocellulosic biomass, into monosaccharides (Flint *et al.*, 2008).

It has been demonstrated that more than 400 bacteria species are present in the human colon flora (with 40 species present in large quantities) (Grizard *et al.*, 1999). Identification of the main organisms responsible for breakdown of food ingredients is difficult due to the complexities of the colonic environment (Grizard *et al.*, 1999). The dominant organisms in terms of numbers are anaerobes including bacteroides, bifidobacteria, eubacteria, streptococci, and lactobacilli, while others, such as enterobacteria, also may be found, usually in fewer numbers (Topping *et al.*, 2001). Bacterial numbers, fermentation, and proliferation are greatest in the proximal large bowel where substrates are highest (Topping *et al.*, 2001). The colonic microflora should change in response to gross nutritional shifts (e.g. weaning), progressive change (such as aging), or variations in food intake. In aged persons, *Escherichia coli*, streptococci, and clostridia increase and bifidobacteria decrease further (Mitsuoka 1996).

The basic fermentative reaction in the human colon is similar to that in obligate herbivores: hydrolysis of polysaccharides, oligosaccharides, and disaccharides to their constituent sugars, which are then fermented resulting in an increased biomass (Savage, 1986). Fermentation yields metabolizable energy for microbial growth and maintenance and also metabolic end products (Topping *et al.*, 2001).

However, manipulating the colon flora by stimulating the growth of potentially beneficial commensal bacteria such as bifidobacteria or lactobacilli can thus have positive effects on human health (Grizard *et al.*, 1999). In general, non-digestible carbohydrates reach the large intestine where they are used by resident saccharolytic microflora to give bacterial biomass and various intermediate and end products, including gases (hydrogen, carbon dioxide and methane), short-chain fatty acids (SCFA, mainly acetate, propionate and butyrate), organic acids (lactate, succinate and pyruvate) and ethanol (Grizard *et al.*, 1999).

Microorganisms are active in different parts of the intestine and depending on the location produce various metabolites. Intestinal microbiota mainly relies on food content that escapes the digestion and reaches the intestine (Ketabi, 2011b). Therefore, the type and amount of food that reaches the colon is very crucial to the microbiota (Flint *et al.*, 2008).

The largest effect of NDO is through the stimulation of microbiota that already colonized in the large intestine, decreasing of the luminal pH and production of short chain fatty acids (SCFA). Microbiota in the colon is influenced both by the host and the diet (Flint *et al.*, 2008).

IMO are considered as non-digestible oligosaccharides, and are also carbohydrate sources in habitats populated by lactobacilli and bifidobacteria which are the host-adapted species of microbiota (Ketabi, 2011b). NDO and polysaccharides are selectively fermented and allow specific changes, both in the composition and/or activity of gastrointestinal microbiota and confer benefits upon host well-being and health (Roberfroid, 2007b). IMO are partially hydrolyzed in the small intestine and ultimately reach the colon (Cummings, 1997; Ketabi, 2011b).

Kaneko *et al.* (1995) investigated the digestibility of an IMO mixture and its hydrogenated derivative (IMH) using the rat jujunum loops method that luminal clearance was as the indicator of their digestibility. They were compared with a disaccharide fraction (IM2) and a higher oligosaccharide fraction (IM3) that were prepared from IMO, typical digestible saccharides (maltose, maltotriose and sucrose), and typical non-digestible saccharides (maltitol, raffinose and fructo-oligosaccharides). The results showed that the clearance rate of IMO was significantly smaller than that of IM2, which was mainly composed of isomaltose (64.3%), and digestible saccharides, and significantly larger than that of non-digestible saccharides.

NDO and polysaccharides usually have a laxative effect when taken in high dosage. However, IMO are tolerated at high dosages compared with other NDO (Kaneko *et al.*, 1994).

4.3 Toxicological Studies

Kaneko *et al.* (1990) conducted comprehensive toxicological studies to investigate the toxicity of IMO. The two types of IMO compositions show in Table 13.

Table 13 Saccharide Compositions of Two Types of Isomaltooligosaccharides (IMO)

	Water content (%)	Compositions of Isomalto-oligosaccharides	Content (% , dry base)
IMO-900	24.0	DP2	52.5
		DP3	25.4
		≥DP4	15.2
IMO-900P	3.6	DP2	38.0
		DP3	25.2
		≥DP4	23.7

DP: Degree of Polymerization; DP2: isomaltose and others; DP3: panose, isomaltotriose and others; ≥DP4: isomaltotetraose and others. Excerpted from Kaneko *et al.* 1990.

4.3.1. Acute Studies

Kaneko *et al.* (1990) performed an acute study using IMO mixture in six (24) male Wistar rats, divided into 4 groups with six (6) rats each group, by oral administration IMO mixture for 14 days. The IMO mixture consisting of di-, tri- and larger oligosaccharides (*i.e.*, 52.5, 25.4 and 15.2%, respectively). The dose levels of oral administration were 15.6, 22.0, 31.1 and 44.0 g/kg body weight, respectively. There were not found dead in the dose levels of 15.6, 22.0 and 31.1. Two (2) of the 6 treated rats died in the highest dose level of 44 g/kg bw. The results exhibited a very low order of acute oral toxicity with LD₅₀ values estimated to be greater than 44 g/kg body weight.

4.3.2. Subchronic and Chronic Toxicological Studies

The subchronic and chronic toxicological studies for IMO mixture were conducted by using rats that were administered IMO mixture in the diet or in the drinking water. The results are summarized in Table 14 below, and briefly described in the following section.

Table 14 Summary of Oral Subchronic and Chronic Animal Toxicity Studies with Isomalto-oligosaccharide (IMO) Products

Species (Strain, sex, no./group)	Duration (day)	Concentration (Dose levels)	Study-end Results ¹	References
Rat (Sprague Dawley)	35	0 (corn starch) or 20% in diet (~0 and 20 g/kg bw/day, respectively)	<ul style="list-style-type: none"> ▪ ↓ in FUE and TG; ▪ No Δ in body weight gain, food intake, cecal contents, and relative organ weights (stomach, small intestine, cecum, colon, liver, kidney, retroabdominal adipose tissue); ▪ No Δ in serum and liver total Ch and PL, and serum HDL-Ch and NEFA. 	Kaneko <i>et al.</i> (1992)
Rat (Sprague- Dawley; male; 5- 6/group)	42	0 (Purina rat chow), 5, 10, or 20% in diet (~0, 5, 10, and 20 g/kg bw/day, respectively)	<ul style="list-style-type: none"> ▪ ↑ in weight cecum at 10 and 20%; ▪ ↓ (dose-dependent) in abdominal fat gain (normalized for food intake); ▪ No Δ in food intake, body weight gain, and absolute heart, spleen, kidneys, lungs, and brown and white tissue weight. 	Day & Chung (2004)
Rat (Wistar; male; 8/group)	365 (1 year)	0 or 3% in drinking water (~0 and 3-5 g/kg bw/day,	<ul style="list-style-type: none"> ▪ No Δ in body weight gain and body weights, AST, ALP, LDH, Cre, BUN(↓ in 1st month), UA, total Ch, TG, WBC and RBC; 	Kaneko <i>et al.</i> (1990)

- respectively)
- ↓ in serum Hb, and ALT;
 - No gross or histopathological abnormalities;
 - ↑ in Lactobacillus count and bifidobacterium frequency of occurrence;
 - ↓ Clostridium.

No Δ = No variations between test and control animals; ALP = Alkaline phosphatase; ALT = Alanine aminotransferase; AST = Aspartate aminotransferase ; BUN = Blood urea nitrogen; Ch = Cholesterol; Cre = Creatinine; FUE = Food utilization efficiency; Hb = Hemoglobin; HDL-Ch = High density lipoprotein cholesterol; Ht = Hematocrit; LDH = Lactate dehydrogenase; NEFA = Non-esterified fatty acids; PL = Phospholipids; RBC = Red blood cell count; TG = Triglycerides; UA = Uric acid; WBC = White blood cell count.

¹ Study-end results unless otherwise indicated; Results are provided for test animals relative to controls.

Excerpted from and modified to FDA GRN 2009.

In the single dose toxicity study performed by Kaneko *et al.* (1990), total sixty four (64) male Wistar rats were randomly divided into two (2) groups with 32 per group. The testing group received 3% of an IMO product in drinking water providing daily that dose level in the range of approximately 3 to 5 g/kg bw for a period of 12 months. The control group did not receive any IMO during the test. The interim clinical evaluations were conducted at months 1, 3 and 6 with 8 rats each time for both testing and control group. At study completion, blood samples were collected for standard clinical chemistry analysis and the animals were sacrificed for histopathological examinations. Body weights of IMO-treated males remained comparable to those of control animals during the treatment period. At study completion, significant variations in hematology and clinical chemistry parameters were limited to decreases in levels of hemoglobin, hematocrit, and alanine aminotransferase (ALT) in test animals compared to controls. However, neither the gross necropsy nor the histopathological examination revealed any abnormalities related to the administration of the IMO preparation. In additional detailed analysis of white blood cell levels conducted to determine any potential immune stimulatory effects, no changes were observed in the absolute number of white blood cells of test rats relative to levels reported in the control group, whereas significant variations in total and individual subgroups of lymphocytes (*i.e.*, elevated levels of total lymphocytes, total T cells, B cells, and helper and suppressor T cells) were limited to the first treatment month. The intake of IMO by the rats in long-term studies was estimated to be 2.7 to 5.0g/kg/day.

In a short-term animal study, several different digestible and non-digestible sugars were compared; a group of 8 male Sprague-Dawley rats was administered 20% of an IMO mixture

in the diet (approximately 20 g/kg bw/day) for a period of 35 days (Kaneko *et al.*, 1992). In comparison to the basal diet (corn starch) control group, final body weights, body weight gain, and food intake of IMO-treated rats were slightly reduced, but not at levels of statistical significance. A statistically significant decrease was, however, observed in the food utilization efficiency of IMO-treated rats. Relative weights of a series of major organs including the liver in rats treated with the IMO mixture were comparable to those reported in the basal diet controls.

In a 6-week study (Day and Chung, 2004), the 2-month-old male Sprague-Dawley rats were divided into four groups of 5 to 6 rats per group. One group (the control) was fed standard rat chow (Purina rat chow). The other three groups were fed IMO-supplemented rat chow at a concentration of 5%, 10%, and 20%, respectively (approximately 5, 10 and 20 g/kg bw/day, respectively). The food intake and weight gain was measured twice a week for six weeks. At the end of six weeks, the rats were sacrificed to examine the weights of the major organs. There were no significant differences in food intake (although a trend toward an increase in the IMO food intake was seen; $p < 0.058$). Weight gain and weights of a series of major organs, including heart, spleen, kidneys, lungs, brown adipose tissue, and white adipose tissue, were determined, and the results were comparable to the control. However, there were significant differences in the weight of the caecum with an increased weight measured especially in the 10% and 20% IMO groups. This probably indicates an increase in the population of fermentation bacteria. Blood was also taken for future analysis. A significant effect of the IMO concentration on the abdominal fat gain when normalized for food intake was observed. A significant decrease was seen in abdominal fat with increasing levels of IMO in the feed. These data indicate that IMO-supplemented food is non-toxic. More importantly, this indicates that IMO-supplemented food can reduce either the formation or deposition of fat. It is also predicted that the blood glucose level will be less in rats fed the IMO-supplemented food.

Ly *et al.* (1999) conducted a study for evaluating the effects of oligosaccharides (fructo- or isomalto-) contained in sponge cake on blood lipids and intestinal physiology in rats. Even though the study was designed primarily to assess the potential effects of IMO preparations on metabolic end-points and intestinal physiology, but it also included determinations of body weights and body weight gain, food intake, and liver and/or kidney weights. The experimental diet was mixed with 30% sponge cakes, which presents 12% of IMO on the diet (sponge cakes with 40% of the sucrose content replaced by IMO mixture and added to diet at 30%). Normal male Sprague-Dawley rats weighing about 530 g were randomly assigned to three groups and placed on experimental diets and deionized water at free access for 25 days. Rats in control

group received a diet with sponge cake containing sucrose at 21.58 g/100 g diet and rats in the other two groups received diets mixed with sponge cakes of which 40% sucrose was replaced with both fructooligosaccharide (FO) and in isomaltooligosaccharide (IMO) (approximate at the level of 12%). The results exhibited no significant differences in efficiency of food, liver weight and intestinal length were observed among groups. The water contents of fresh feces of IMO and FO groups were higher than control. Dry fecal weight increased significantly in isomaltooligosaccharide (IMO) group. The pH of cecal contents decreased significantly in two oligosaccharide groups.

Chai *et al.* (2001) conduct a study to examine the effects of dietary oligosaccharide on the blood glucose and serum lipid composition in streptozotocin (STZ)-induced diabetic rats. Sprague-Dawley male rats were randomly assigned to one normal and four STZ-induced diabetic groups. Diabetic groups were classified to basal diet (DM group), 10% xylooligosaccharide diet (DM-XO group), 10% isomaltooligosaccharide (DM-IMO group), and 10% fructooligosaccharide (DM-FO). Diabetes was experimentally induced by intravenous injection of 50 mg/kg of body weight of STZ in citrate buffer (pH 4.3) after feeding of experimental diets for 4 weeks. These rats were fed with experimental diets in diabetic state for further 4 weeks. The oligosaccharide diets were not affected on the body weight, food intakes and food efficiency ratio. The oligosaccharide diets were also not affected on the weights of liver, kidney and small intestine, but the weight of cecum was significantly increased on the groups of xylooligosaccharide and isomaltooligosaccharide diet.

Seven older male subjects participated in this study that consisted of a 30-day control low fiber period followed by a 30-day IO-supplemented (10 g active components) experimental period. Bowel functions such as defecation, enema use and bloating were monitored daily. Fecal characteristics such as wet and dry stool weights, stool moisture, pH and short-chain fatty acid contents were determined on five-day fecal composites collected in each period. Incorporation of IO significantly increased the defecation frequency, wet stool output and dry stool weight by two fold, 70% and 55%, respectively. Fecal acetate and propionate concentrations significantly increased by nearly two and a half fold with IO supplement. The increase in stool bulk was mainly attributed by increased bacterial mass. Mean serum sodium concentration decreased in the experimental period while other blood characteristics did not change significantly. Anthropometric parameters and nutrient intake remained constant throughout the study. Consumption of IO effectively improved bowel movement, stool output and microbial fermentation in the colon without any adverse effect observed in this study (Chen, *et al.*, 2001).

4.3.3. Genotoxicity Studies

A mutagenicity test by Ames' method was carried out to evaluate *in vitro* in a standard battery of *Salmonella typhimurium* (i.e., TA98, TA100, TA1535 and TA1537) and in *Escherichia coli* WP2uvrA with and without metabolic activation, the IMO mixture did not induce significant increases in the number of revertant colonies at concentration of up to 10% per plate (Kaneko *et al.*, 1990). In a chromosome aberration test using Chinese hamster lung (CHL) cells were also carried out to evaluate chromosome aberration. The IMO mixture failed to significantly increase the number of chromosome aberrations in Chinese hamster lung (CHL) cells at concentrations of up to 3% in either the absence or presence of a bioactivation system following a 24- or 48-hour incubation period (Kaneko *et al.*, 1990).

4.4. Human Tolerance Studies

The human tolerance studies conducted with IMO are summarized in Table 12. IMO are generally tolerated at higher dosages compared to other non-digestible oligosaccharides (Kaneko *et al.*, 1994).

Several human studies ranging from 7 to 30 days in duration that were primarily designed to assess various indices related to the putative prebiotic properties of IMO preparation, also evaluated their tolerability. Additionally, several authors have reported a threshold value of 1.5 g/kg body weight or greater (approximately 90 g in the case of a 60kg individual) for the induction of transient diarrhea resulting from the consumption of single dose of isomalto-oligosaccharides (Oku and Okazaki, 1999; Oku and Nakamura, 2002).

While ingestion of single 20 g doses of FOS or galactosyl-sucrose induced various abdominal discomforts (e.g., distention, borborygmus, flatus), no gastrointestinal disturbances were observed following consumption of up to 40 g of an IMO product (Oku and Nakamura, 2003). Similarly, no gastrointestinal symptoms were reported by study participants following repeat ingestion of an IMO mixture at dose levels of 10 to 15 g for a period of 3 weeks, with a 1-week IMO free interval between 2 consecutive weeks of treatment followed by another 7 days of IMO ingestion (Kaneko *et al.*, 1993).

Conversely, in 2 other studies, increases were reported in the severity of incidence of various gastrointestinal symptoms (e.g., flatulence, abdominal pain and distention, borborygmus) following consumption of 20 or 30 g of IMO mixture for 10 or 28 days in comparison to baseline levels. However, in none of these studies did the subjects experience increased incidences or severity of diarrhea (Kohmoto *et al.*, 1988; Wang *et al.*, 2001). Moreover, increased flatulence reported by individuals in the study conducted by Kohmoto *et al.* (1988) was only temporary and subsided with treatment, suggesting that the microfloral population

adapted to changes in the amount of undigested material passing into the colon. In a study conducted with a group of elderly men with a history of chronic constipation, a 3-fold increase in defecation frequency and significantly greater wet and dry fecal weight per day per stool sample were reported following consumption to a 30-day control period; however, changes in bowel movements and stool characteristics were not accompanied by any reports of gastrointestinal discomforts (Chen *et al.*, 2001). Moreover, in a placebo-controlled, double-blind study, gastrointestinal disturbances in subjects consuming daily 10 g of an IMO preparation for a period of 7 days increased only in comparison to a 7-day run-in period, but not in comparison to the placebo (Bouhnik *et al.*, 2004). None of the subjects experienced diarrhea.

In 2 studies which also included evaluations of clinical biochemistry, no significant variations were observed in several clinical chemistry parameters (e.g., total protein, albumin, blood urea nitrogen, creatinine) when elderly subjects or hemodialysis patients were provided daily 24 or 30 g of an IMO preparation for 30 and 28 days, respectively (Chen *et al.*, 2001; Wang *et al.*, 2001). In comparison to pre-treatment values, the hemodialysis patients did however, exhibit elevated hemoglobin and hematocrit values following ingestion of the IMO mixture, which as suggested by the authors may have been at least in part due to enhanced iron absorption (Wang *et al.*, 2001).

The Summary of human tolerance studies with IMO products is listed in Table 15 below.

Table 15 Summary of Human Tolerance Studies with IMO Products

Study Population and design	Duration	Daily Dose Levels	Results	Reference
9 healthy males (~26 years old) and 29 females (~23 years old)	Single dose	10, 20 or 40 g	No GI disturbances	Oku and Nakamura (2003)
81 healthy males and 119 females (~30 years old) (8 ingested IMO mix); double-blind placebo-controlled study	7 day run-in and 7-day treatment period	0 (placebo) or 10 g/day (2 equal portions)	<ul style="list-style-type: none"> ▪ ↑ (slight) in excess flatus, bloating, borborygmi, and abdominal pains (all mild symptoms) <i>vs.</i> run-in period, however, no Δ in any of the GI symptoms <i>vs.</i> placebo control; ▪ None of the subjects experienced diarrhea. 	Bouhnik <i>et al.</i> (2004)
6 healthy males (26-48 years old)	10 days	20 g/day	<ul style="list-style-type: none"> ▪ None of the subjects experienced diarrhea; ▪ Only transient increase in flatulence in 2/24 subjects. 	Kohmoto <i>et al.</i> (1988)
18 older subjects (5 males and 13 females; 50-93 years old)	14 days			
20 healthy females and	21 days	10 or 15 g	<ul style="list-style-type: none"> ▪ No GI disturbances 	Kaneko <i>et</i>

11 males (22 subjects w/history of constipation) (~27-30 years old)	(total) ²		<ul style="list-style-type: none"> ▪ ↑ defecation frequency in constipated subjects w/15 g IMO mix vs. 1st week. 	<i>al.</i> (1993)
8 males and 12 females hemodialysis patients (~64 years old)	14 days run-in and 28-day treatment period	30 g/day (2 equal portions)	<ul style="list-style-type: none"> ▪ ↑ in severity of distension (10%)¹, tominia (10.5%), borborygmi (6.1%), spasms (4.5), and in bowel movements; ▪ No Δ in diarrhea (5%); <p><u>Clinical Chemistry</u></p> <ul style="list-style-type: none"> ▪ ↑ in Hb, and HDL-Ch vs. run-in; ▪ ↓ in Tg, and total Ch; ▪ No Δ in glucose, albumin, total protein, BUN, Cre, Ca²⁺, P, and LDL-Ch. 	Wang <i>et al.</i> (2001)
7 elderly males w/ history of constipation (~75 year old)	30-day run-in and 30-day treatment period	↑ from 8 to 24 g (1 st 10 days)	<ul style="list-style-type: none"> ▪ ↑ in defecation frequency and wet and dry fecal weight per day and stool sample; ▪ No reports of GI disturbances. <p><u>Clinical Chemistry</u></p> <ul style="list-style-type: none"> ▪ ↑ in Na⁺; ▪ No Δ glucose, total protein, albumin, TG, Ch, HDL-Ch, Ca²⁺, P, and K vs. run-in. 	Chen <i>et al.</i> (2001)

No Δ=No change; BUN=Blood urea nitrogen; Ca²⁺=Calcium; Cre=Creatinine; Ch= Cholesterol; Hb = Hemoglobin; GI=Gastrointestinal;; HDL-Ch=High density lipoprotein cholesterol; Ht=hematocrit; LDL-Ch=low density lipoprotein cholesterol; K=Potassium; Na⁺=Sodium; P=Phosphorus; TG=Triglycerides.

¹ Percent in parentheses indicates percent of patients experiencing GI symptoms.

² 1st week run-in period; 2nd and 3rd week IMO mix ingestion; 4th week break; 5th week IMO mix ingestion.

Excerpted from FDA GRN (2009)

4.5. Nutritional Considerations of IMO

Isomalto-oligosaccharides are widely used as low caloric sweeteners in food industry for many years. As a food ingredient, IMO, as well as other oligosaccharides, has not only a great potential to improve the quality and the physicochemical properties of many foods (due to its mild sweetness, relatively low viscosity, and high moisture retaining properties, etc.), but also with physiologically unique functions, including the improvement of intestinal microflora based on the selective proliferation of bifidobacteria and lactobocilli, stimulation of mineral absorption, and the improvement of both cholesterol and blood glucose level (Nakakuki. 2002).

4.5.1. Fermentation in Colon and Colon Microflora

As described previously, IMO are partially digested by enzymes of the small intestine (Kaneko *et al.*, 1992; Kaneko, 1995; Ketabi *et al.*, 2011a), and the undigested portion of IMO

are considered as non-digestible oligosaccharides that reach the colon largely intact and fermented in the colon by colon microflora (Ketabi, 2011b; Kohmoto *et al.*, 1992).

Fermentation in colon dominates the large bowel function. It gives rise to hydrogen (H₂), carbon dioxide (CO₂), methane (CH₄), lactic acid, and short-chain fatty acids (SCFA), as well as biomass (Grizard *et al.*, 1999; Cummings, 1997). The hydrogen and carbon dioxide are excreted; biomass (bacteria) in turn affects a number of metabolic processes in the colon, and is excreted in feces (Cummings, 1997). In addition to providing products that are absorbed and reach the liver and peripheral tissues, fermentation affects every process including salt and water absorption, pH, epithelial cell metabolism, motility and bowel habit, and colonization resistance (Cummings, 1997).

As carbon source for anaerobic microflora in colon, the undigested IMO portion undergoes the fermentation processes that stimulate the growth and proliferation of certain bacteria subpopulations that benefit the host colon health. For example, stimulation of *bifidobacteria* in colon may have of the following positive health benefits: potential protective effects against colorectal cancer and infectious bowel diseases by inhibiting putrefactive bacteria (*Clostridium perfringens*) and pathogen bacteria (*Escherichia coli*, *Salmonella*, *Listeria* and *Shigella*), respectively; improvement of carbohydrate and lipid metabolisms; fiber-like properties by decreasing the renal nitrogen excretion; improvement in the bioavailability of essential minerals; and low cariogenic factor (Grizard *et al.*, 1999).

In vitro Studies

A series of *in vitro* studies for investigating effects of IMO on human intestinal microflora and briefly described below.

To observe the utilization of several oligosaccharides by intestinal bacteria an *in vitro* study was conducted by Kohmoto *et al.* in 1988. Fifty-nine (59) strains were used in this test, the test medium contained each oligosaccharide in a concentration of 0.5%, and 0.1 ml of inoculums (10⁸ cfu/ml) was used per 5 ml of test medium. Incubation was carried out at 37⁰C for 48 hours under anaerobic condition. The results showed that isomaltose, isomaltotriose, panose and IMO-900[®] were utilized by *bifidobacteria* except *bifidobacterium bifidum* (Kohmoto *et al.*, 1988). In another study, adding 0.5-0.6% IMO to basic medium could remarkably promote the multiplication of bifidobacterium (Qiu, *et al.*, 1999). In an *in vitro* study, the results showed that the oligosaccharides differed in their fermentation characteristics and IMO mixture were effective at increasing numbers of *bifidobacteria* (Rycroft *et al.*, 2001). The more recent study showed that soybean oligosaccharide, IMO and FOS exhibited the stimulation growth effects for the testing bacterium, *Bifidobacterium sp.*

A04. Soybean oligosaccharide was the most effective compared to IMO and FOS (Jiang *et al.*, 2005). In another study, anaerobic culture of *Bifidobacterium breve* using IMO, xylooligosaccharide and composite oligosaccharide as carbon source were conducted, and the results showed that the oligosaccharides can proliferate *Bifidobacterium breve* effectively, and the optimum concentration of the oligosaccharides was around 1.0% (Xiao *et al.*, 2005). Wan *et al.* (2007) conducted a study to observe the effect of IMO and FOS on the multiplication of *Lactobacillus acidophilus*, *Lactobacillus lactis* and *Streptococcus lactis in vitro*. The three bacteria were cultured in MRS broth and nutrition broth, respectively, for 48 hours. Each experiment was divided into IMO group (30 g/L), FOS group (30 g/L) and control group, and plate count was carried out at 0, 24 and 48 hours, respectively. The results showed that the multiplications of *lactobacilli* in IMO and FOS groups cultured in MRS medium were increased with time, but they had no significant difference compared with the control group ($p>0.05$). However, in common nutrition medium with IMO and FOS were added, the multiplications of *lactobacilli* were found increased significantly ($p<0.05$) compared with the control group, which indicated that IMO and FOS could promote the multiplication of *lactobacilli*, especially in the nutrition broth (Wan *et al.*, 2007).

In vivo Studies using rats and mice model systems

In a long term test, male Wistar rats were fed *ad libitum* with drinking water containing 3% IMO for 12 months, and the results showed that IMO could stimulate *Bifidobacterium* growth and suppression of *Clostridium* growth (Kaneko *et al.*, 1990).

In the mice study, 40 BABL/c mice were divided into 4 groups with 10 for each group. 3 experimental groups and 1 control group. The three (3) experimental groups were fed different dose of IMO by gavage for 7 days. Feces of mice were determined before and at the end of the experiment. The results showed that the reproduction of *Bifidobacteria* and *Lactobacillus* greatly increased, and the growth of *Clostridium perfringenes* was significantly inhibited in mice (Gu *et al.*, 2003). The regulative function of IMO on mice intestinal flora was studied. The results showed that IMO could regulate the intestinal flora and improve the reproduction of *bifidobacteria* in mice (Yao *et al.*, 1999). In a more recent 14-day mice study, the effects of oligo-isomaltose on the quantities and metabolic products of *Escherichia coli*, *coccobacillus*, *bifidobacterium* and *Clostridium welchii* in the intestines of mice were evaluated. 24 young mice with the average weight of (20.754 ± 2.282) g were grouped into four (4) groups: the high, medium, low and control groups, and then determined the weight of mice and the quantity of flora and metabolic products in the excrement collected at the 0th day, the 7th day, and the 14th day. The results showed that in comparison with the control group, different dosage levels of oligo-isomaltose had effects on *bifidobacterium* ($P<0.05$), and significant

difference ($P < 0.01$) was showed in the high dosage and intermediate dosage of oligo-isomaltose (Wang, *et al.*, 2012). Katabi (2011) reported that in the rats study, feeding IMO significantly increased rDNA copy numbers of fecal organisms in the *lactobacillus* group compared to rats on control group. The number of *bifidobacteria* in fecal samples from rats fed IMO was low and significantly different from animals fed the control diet at eleven weeks of age. Fecal *clostridial* cluster XI and *Enterobacteraceae* decreased over time in both treatment groups. The *Bacteroides* group as well as *clostridial* clusters I, IV, and XIV were not affected by diets or time. Total number of fecal bacteria was increased in rats fed IMO compared to control diet (Ketabi, 2011b).

Human *in vivo* Studies

In a study of investigating changes in human fecal flora by the administration of IMO-900[®]), the intake of IMO (13.5 g/day for 2-week) to healthy adult man and senile persons, the numbers of *bifidobacteria* in the feces increased, and the consistency of feces was improved (Kohmoto 1988). In another human study, the minimum dosage of IMO for the proliferation of bifidobacteria was determined. Twelve healthy adults men were administered IMO-900[®] (consisting 85.4% IMO on dry basis, 10.5% maltose and maltotriose, and 4.1% glucose). The results showed that intake of 8.2 g IMO per day tended to increase the bifidobacterial cells, and intake of 9.8 g/day increased significantly ($p < 0.10$) (Kohmoto *et al.*, 1991). The effects of isomaltooligosaccharides (IMO) intake at 10 g/day level on the fecal microflora and their metabolites were studied in seven healthy volunteers. The number of *Bifidobacterium* and *Lactobacillus* in feces was significantly increased, and in contrast not only the frequency of occurrence of *Clostridium* but also the percentage of Bacteroidaceae to the total microflora was decreased (Kaneko *et al.*, 1993). The regulative function of IMO on human intestinal flora was studied. The results showed that IMO could regulate the intestinal flora and improve the reproduction of intestinal *bifidobacteria* and in *lactobacillus* (Yao *et al.*, 1999). IMO (ZONG HENG brand, IMO $\geq 51\%$) was studied. Experiment results showed that the intake of 5-30 grams of the IMO product (equivalence to 2.5-15 g IMO) could regulate the intestinal flora, improve the reproduction of *Bifidobacteria*, and inhibit the growth of *Clostridium perfringenes* in human being (Fu, *et al.*, 1999). To evaluate effects of isomalto-oligosaccharides (IO) on the bowel function and nutritional status of elderly men. Seven older male subjects participated in this study that consisted of a 30-day control low fiber period followed by a 30-day IMO-supplemented (10 g active components) experimental period. Incorporation of IO significantly increased the defecation frequency, wet stool output and dry stool weight by twofold, 70% and 55%, respectively. Fecal acetate and propionate concentrations significantly increased by nearly two and a half fold with IO supplement. The

increase in stool bulk was mainly attributed by increased bacterial mass. Mean serum sodium concentration decreased in the experimental period while other blood characteristics did not change significantly. Anthropometric parameters and nutrient intake remained constant throughout the study. Consumption of IMO effectively improved bowel movement, stool output and microbial fermentation in the colon without any adverse effect observed in this study (Chen, *et al.*, 2001). Gu *et al.* (2003) conducted in vivo studies to evaluate the effects of IMO on intestinal flora using both human and mice as the experimental subjects. In the human study, 30 health subjects (15 male, 15 female) were randomly selected from the clinic of Center for Diseases Control in Tianjin. They were provided 30 g IMO product (equivalence to 15 g IMO) once a day for 7 days. The results showed that the reproduction of *Bifidobacteria* and *Lactobacillus* greatly increased, and the growth of *Clostridium perfringenes* was significantly inhibited in human intestinal tracts (Gu *et al.*, 2003).

However, a 7-day double-blind human study performed by Bouhnik *et al.* in 2004 showed that ingested 10 g/day of IMO were not found bifidogenic compared to the placebo group in phase I study. In phase II study, no significant dose x time interaction was found (Bouhnik *et al.* 2004). The results of this study did not confirm the above results of human studies. It is worthy to state that the composition of the IMO product used in this study was not identified, so the simple comparison with the IMO products used in the above human studies seems lack a common base.

4.5.2. Short-Chain Fatty Acids (SCFA)

Since IMO mixture are partially digested in small intestine, the undigested portion passes to the lower intestinal tract (Kaneko *et al.*, 1992; Kaneko, 1995; Ketabi *et al.*, 2011a) where it undergoes fermentation by intestinal bacteria, and give rise to hydrogen (H₂), carbon dioxide (CO₂), methane (CH₄), lactic acid, and short-chain fatty acids (SCFA) that primarily consists of acetate, propionate, and butyrate, as end products (Roy *et al.*, 2006; Wong *et al.*, 2006).

SCFA are the principal products of fermentation and, through their absorption and metabolism, the host is able to salvage energy from undigested food in the upper intestine. SCFA affect colonic epithelial cell transport, colonocyte metabolism, growth and differentiation, hepatic control of lipid and carbohydrates, and provide energy to muscle, kidney, heart and brain (Cumming, 1997; Henningsson *et al.*, 2001). As the main anions of the colon and the major source of energy for colonocytes, SCFAs are readily absorbed (Wong *et al.*, 2006). Butyrate is the major energy source for colonocytes; propionate is largely taken up by the liver; acetate enters the peripheral circulation to be metabolized by peripheral tissues. Acetate is the principal SCFA in the colon, and after absorption it has been shown to increase cholesterol

synthesis (Wong *et al.*, 2006; Hijova & Chmelarova, 2007). The rate and amount of SCFA production depends on the species and amounts of microflora present in the colon, the substrate source and gut transit time (Wong *et al.*, 2006). SCFA in general and butyrate in particular enhance the growth of *lactobacilli* and *bifidobacteria* and play a central role on the physiology and metabolism of the colon (Roy *et al.*, 2006). The short-chain fatty acids regulate the size and function of the colonic regulatory T cells (Treg) pool and protect against colitis in a Ffar2-dependent manner in mice. The study revealed that a class of abundant microbial metabolites underlies adaptive immune microbiota coadaptation and promotes colonic homeostasis and health (Patrick, *et al.*, 2013; Park, *et al.*, 2015).

In vitro Studies

In an *in vitro*, the levels of SCFA measured in the fermentations were observed. Significant increases in lactate and acetate in substrates with IMO added. No variations were observed in levels of propionate and butyrate (Rycroft *et al.*, 2001). In another *in vitro* study, the net production of total SCFA (sum of acetic, propionic and n-butyric acid weights) from cultures with soybean- and isomalto-oligosaccharides, raffinose, gentiobiose and lactosucrose was greater than that from blank culture (Kihara and Sakata, 2003).

In vivo Studies

In a rat *in vivo* study, no changes were observed in levels of individual short-chain fatty acids following administration of 5% IMO mixture in the diet (approximately 2.5 g/kg bw) compared to a control group (Ohta *et al.*, 1993). In another *in vivo* study, IMO mixture exhibited a significant influence on the quantities of the metabolic products (*i.e.* acetic acid, propionic acid, n-butyric acid and isobutyric acid), and adjusted the content and constitution of the metabolic products of mice intestinal flora (Wang, *et al.*, 2012). In another rats study, SCFA were analyzed in the fecal samples of rats fed IMO or inulin diet. Acetate, butyrate and propionate were the dominant components in SCFA. Inulin diet did not change fecal SCFA concentrations compared to rats on a control diet. However, IMO significantly decreased fecal acetate compared to rats fed control diet. Total SCFA was also decreased in rats fed IMO diet compared to control and inulin treatments. Propionate, butyrate, isobutyrate, isovalerate and caproate were not affected by dietary intervention treatment (Ketabi, 2011b).

In Human Studies

In a human study, seven older male subjects supplemented IMO (10 g active components) for 10 days. The results showed that fecal acetate and propionate concentrations significantly increased by nearly two and a half fold, respectively, with IMO supplement (Chen *et al.* 2001).

In another human study, the effects of isomaltooligosaccharides (IMO) intake at 10 g/day level on the fecal microflora and their metabolites were studied in seven healthy volunteers were observed. The fecal contents of short chain fatty acids, especially acetic acid, were increased. Furthermore, the effects of IMO intake at 10 or 15 g/day level on defecation were studied in thirty-one healthy volunteers. The results showed that the contents of fecal acetic acid increased with IMO intake, and the significant correlations with the numbers of *Bifidobacterium* in feces, the frequency of defecation and fecal pH were found (Kaneko, *et al.*, 1993).

Table 16 Composition of Isomalto-oligosaccharides (IMO) Products¹ Tested in the Published Studies

Test Mat.	DP1 (%)		DP2 (%)			DP3 (%)				DP4 (%)		DP5 (%)		DP6 (%)		Other (%)		Reference
	Glu	Fru	M	IsoM	O	P	M	IsoM	O	M	IsoM	M	IsoM	M	IsoM	IMO	Dex	
BLB@IMO*	-	-																
Vitasuger*	-	-	5-6	20-15	-	20-25		25-30	-	-	15	-	7-9	-	4-5	<10	-	FDA GRN 2009
IMO	20.9	0.5	15.4	12.0	-	29.1	3.9	2.6	-	3.2	9.9	-		-		-	2.5	Chen <i>et al.</i> (2001); Wang <i>et al.</i> (2001)
IMO	<0.2		6.9			28.4	-	-	-	36.7		19.1		7.4		1.2	-	Day & Chung (2004)
IMO-900P	-	-	38.0			25.2				23.7				-	-	Kaneko <i>et al.</i> (1990)		
IMO-900	-	-	52.5			25.4				15.2				-	-			
IMO_900P®	-	-	-	34.4	-	12.2	-	14.7	-	-	16.2	-		-		10.6	-	Kaneko <i>et al.</i> (1992)
IMO-900®	3.8	-	4.5	22.8	13.1	11.6	0.9	16.7	-	17.7		7.2		1.7		-	-	Kaneko <i>et al.</i> (1995); Oku & Nakamura (2003)
IMO-2	0.4	-	2.1	64.3	22.3	4.7	-	5.7	-	0.5		-		-		-	-	Kneko <i>et al.</i> (1995)
IMO-3	0.5	-	1.2	1.8	2.4	25.3	2.2	16.5	-	30.7		8.5		10.9		-	-	
IMO-900®	1.8	-	5.1	48.8	3.7	6.9	-	16.9	1.6	15.2				-		-	-	Kohmoto <i>et al.</i> (1988)
IMO-900®	4.1	-	10.5	37.2	-	See DP3 IsoM	See DP2 M	26.8	See DP3 IsoM	21.4				-		-	-	Kohmoto <i>et al.</i> (1991)
IMO-900®	2.4	-	3.6	32.3	9.1	12.3	-	14.8	-	15.5	6.9		3.3		-		-	Kohmoto <i>et al.</i> (1992)
¹³ C-IMO-900®	1.2	-	2.0	32.6	6.9	13.4	-	16.9	-	15.5	6.9		4.6		-		-	

Mat. = Material; DP = Degree of polymerization; Glu. = Glucose; Fru = Fructose; M = Malto-; IsoM = Isomalto-; O = Other; P = Panose; IMO = Isomaltooligosaccharides; Dex. = Dextrin; IMO-2 = Disaccharide fraction from IMO; IMO-3 = Tri- and higher oligosaccharide fraction from IMO.

* Composition based on representative samples – Product Specifications indicate glucose ≤5% and ≥90% isomaltose and DP3 to DP9.

1 Expressed on a dry basis (%).

5 DP6 and greater

2 DP7 and greater.

6 Maltose and maltotriose combined.

3 DP4 and greater.

7 All tri-isomalto-oligosaccharides

4 Nigerose and kojibiose.

Excerpted from and modified to FDA GRN (2009).

5. SUMMARY

The majority of oligosaccharides found in BLB[®] IMO consist of 2 or higher monosaccharide units linked together. The disaccharide fraction of BLB[®] IMO consists of the α -(1,4)-glycosidic bond linked maltose and the α -D-(1,6)- glycosidic bond linked isomaltose, while maltotriose, panose, and isomaltotriose make up the trisaccharide fraction. Maltotetraose, maltopentaose, maltohexaose, maltoheptaose, and small amounts of oligomers with 8 or higher degrees of polymerization (DP) comprise the remaining oligomers in the product.

BLB[®] IMO products are proposed for use as an alternative sweetener as a partial replacement for current available sweeteners in a variety of foods, including baked goods and baking mixes, beverages and beverage bases, breakfast cereals, chewing gum, dairy product analogs, egg products, fats and oils, frozen dairy desserts & mixes, gravies and sauces, hard candy, infant and toddler food (not include infant formula), milk products, processed fruits and fruit juices, soft candy, soups and soup mixes, at use levels of 1.5 to 15 g/serving (reference amounts customarily consumed eating occasion, 21 CFR 101.12). The nutritive value of IMO preparations was estimated to be approximately 2.7 to 3.3 kcal/g or 70 to 80% relative to that of maltose (Kaneko *et al.*, 1992; Kohmoto *et al.*, 1992). BLB[®] IMO products are proposed for use at use-level of up to 15 g/serving. Assuming that a person will consume 2 servings of food per day to which BLB[®] IMO has been added at levels of up to 15 g/serving, a daily intake level of not more than 30 g/ BLB[®] IMO/person is estimated.

BLB[®] IMO is produced, in accordance with current good manufacturing practice (cGMP), from corn starch *via* enzyme-hydrolyzed process that converts the starch molecules into isomalto-oligosaccharides mixture, followed by purification and concentration of the resulting IMO mixture to form a powder or syrup product. All water used in the production is treated by mechanical filtrations, and reverse osmosis membrane filtration. The CIP cleaning system covers all production equipment, pipelines and containers/reactors to assure effective cleaning in timely manner, and to assure the safety and stability of the final products. All starting materials, including enzymes, chemicals, reagents and processing aids are appropriate for use in food and meet the related specifications of the China National Standards.

IMO is very stable under acidic or alkaline conditions (pH 2.0 to 10) (Bioneutra, 2008). The stability of BLB[®] IMO products was studied, and the results are shown in Fig. 3 and Fig. 4 below. The results revealed that IMO was very stable under conditions of pH ranging from 2 to 4 and temperature from 60 to 120 °C, and was stable at high temperature of up to 180 °C, while sucrose was decomposed rapidly in comparison to IMOs. The stability of BLB[®] IMO products (IMO-90 powder) was studied using HPLC method to determine the residual rate of IMO under different conditions. Under neutral condition (pH 7.0), IMO was heat treated at

135°C, 121°C and 85°C for 25 sec, 25 min and 30 min, respectively, the results revealed that IMO was very stable. Under acidic conditions of pH 4.2, IMO was very stable at temperatures of 135°C, 121°C and 85°C for 25 sec, 25 min and 30 min, respectively. IMO was stable at 135°C and 85°C for 25 sec and 30 min, respectively in alkaline condition (pH 7.8). However, 89% of IMO was reserved after heated at 121°C for 25 min in the condition of pH 7.8 (Duan. *et al.* 2009).

The organoleptic specification, the chemical, physical and microbiological specifications for BLB[®] IMO products (syrup and powder) are compliant to the China National Standard of Isomaltooligosaccharides specified in GB/T 20881-2007 (see Appendix P).

The use of BLB[®] IMO in food is mainly limited by the desired sweetness intended for a particular food or beverage products. Therefore, the use of BLB[®] IMO in foods at upper use levels is largely self-limiting based on its organoleptic properties.

The regulatory status for IMO used in foods is widely accepted in world. Currently, U.S. FDA has not questions for the GRAS notice issued by BioNeutra Inc. in 2009 (FDA GRN, 2009). Canada Health approved Vitasugar[™] (IMO produced by BioNeutra Inc.) as a novel food in 2009 (Health Canada, 2009). In 2009, UK Food Standards Agency (FSA) evaluated the application from BioNeutra Inc. regarding placing isomalto-oligosaccharide on the EU market as a novel food ingredient. The application was evaluated by the Advisory Committee on Novel Foods and Processes (ACNFP), the independent Committee, and concluded that isomalto-oligosaccharide meets the criteria for acceptance as a novel food in its initial assessment report in December 2012 (FSA ACNFP 2013). Japan and China are also permitted to use IMO as a food ingredient. Isomalto-oligosaccharide is considered as a starch-related oligosaccharide and was used as a prebiotic in healthy foods since the early 1980s to the late 1990s (Nakakuki T. 2003) in Japan. Isomalto-oligosaccharide is permitted to use in foods as an ingredient in China, and established the national standard of GB/T 20881-2007 (see Appendix P) for IMO in China. According to this standard, IMO is a mixture consisting of isomaltose, panose, isomaltraose, isomaltotetraose, as well as oligosaccharides with higher degree of polymerization.

IMO mixture is partially hydrolyzed in the gastrointestinal tract to glucose, and then the glucose is absorbed and utilized by the body of animals and human (FDA GRN, 2009). The undigested portion of IMO are considered as non-digestible oligosaccharides that escape digestion in the stomach and small intestine and reach the colon largely intact and fermented in the colon by microbiota (Ketabi, 2011b; Kohmoto *et al.*, 1992). Animal and human digestive systems accommodate numerous bacteria specialized in fermentation of non-digestible oligosaccharides (NDO) with various structures and degree of polymerization

(Ketabi, 2011b). Fermentation yields metabolizable energy for microbial growth and maintenance and also metabolic end products (Topping *et al.*, 2001).

The animal toxicity studies exhibited sufficient support that there were not observed adverse effects when consuming IMO mixture. The results of an acute study showed that a very low order of acute oral toxicity with LD₅₀ values estimated to be greater than 44 g/kg body weight (Kaneko *et al.*, 1990). A mutagenicity test by Ames' method showed that the IMO mixture did not induce significant increases in the number of revertant colonies at concentration of up to 10% per plate (Kaneko *et al.*, 1990). In a chromosome aberration test using Chinese hamster lung (CHL) cells, there were not significantly increase the number of chromosome aberrations in Chinese hamster lung (CHL) cells at concentrations of up to 3% in either the absence or presence of a bioactivation system following a 24- or 48-hour incubation period (Kaneko *et al.*, 1990).

In several human studies, ingestion of single 20 g doses of FOS or galactosyl-sucrose induced various abdominal discomforts (e.g., distention, borborygmus, flatus), no gastrointestinal disturbances were observed following consumption of up to 40 g of an IMO product (Oku and Nakamura, 2003). Similarly, no gastrointestinal symptoms were reported by study participants following repeat ingestion of an IMO mixture at dose levels of 10 to 15 g for a period of 3 weeks, with a 1-week IMO free interval between 2 consecutive weeks of treatment followed by another 7 days of IMO ingestion (Kaneko *et al.*, 1993). BLB[®] IMO products are expected to be well tolerated at the intake levels from the proposed use-levels of 30 g/day.

In addition used as low caloric sweetener in food industry, IMO also exhibit certain physiologically unique functions, including the improvement of intestinal microflora based on the selective proliferation of *bifidobacteria* and *lactobocilli*, stimulation of mineral absorption, and the improvement of both cholesterol and blood glucose level (Nakakuki, 2002).

The scientific evidence presented above supports that BLB[®] IMO, a mixture of isomalto-oligosaccharides, would not produce adverse effects on human health under the condition of intended use described herein. As supported by the results of the published animal studies and human studies, there is no risk of systemic toxicity related to the ingestion of IMO. The data and information summarized in this report support the conclusion that BLB[®] IMO products, meeting appropriate food grade specifications, and manufactured in accordance with current good manufacturing practice, would be GRAS substance under the condition of intended use based on scientific procedure.

6. CONCLUSION

We, the Expert Panel, have independently, collectively and critically evaluated the data and information summarized above and conclude that BLB[®] IMO, a mixture of isomalto-oligosaccharides, meeting appropriate food-grade specifications and produced in accordance with current Good Manufacturing Practice, is Generally Recognized as Safe (GRAS) based on scientific procedures under the conditions of intended use in foods specified herein.

(b) (6)

Chi-Tang Ho, Ph.D.

Rutgers, the State University of New Jersey
New Brunswick

Dec. 26 2017

Date

Xiuling Lu, Ph.D.

University of Connecticut

Date

Shiru Jia, Ph.D.

Tianjin University of Science & Technology

Date

6. CONCLUSION

We, the Expert Panel, have independently, collectively and critically evaluated the data and information summarized above and conclude that BLB[®] IMO, a mixture of isomalto-oligosaccharides, meeting appropriate food-grade specifications and produced in accordance with current Good Manufacturing Practice, is Generally Recognized as Safe (GRAS) based on scientific procedures under the conditions of intended use in foods specified herein.

Chi-Tang Ho, Ph.D.

Rutgers, the State University of New Jersey
New Brunswick

(b) (6)

Xiuling Lu, Ph.D.

University of Connecticut

Shiru Jia, Ph.D.

Tianjin University of Science & Technology

Date

12/25/2017

Date

Date

GRAS Notice for Isomalto-oligosaccharides (IMO) Mixture

6. CONCLUSION

We, the Expert Panel, have independently, collectively and critically evaluated the data and information summarized above and conclude that BLB[®] IMO, a mixture of isomalto-oligosaccharides, meeting appropriate food-grade specifications and produced in accordance with current Good Manufacturing Practice, is Generally Recognized as Safe (GRAS) based on scientific procedures under the conditions of intended use in foods specified herein.

Chi-Tang Ho, Ph.D.
Rutgers, the State University of New Jersey
New Brunswick

Date

Xiuling Lu, Ph.D.
University of Connecticut
(b) (6)
Shiru Jia, Ph.D.
Tianjin University of Science & Technology

Date
Dec. 26, 2017

7. REFERENCES

- 21 CFR 101.12 –Reference Amounts Customarily Consumed Per Eating Occasion. <http://www.gpo.gov/fdsys/granule/cfr-2012-title21-vol2/cfr-2012-title21-vol2-sec101-12>.
- 21 CFR 170.3(o)(20). <http://www.gpo.gov/fdsys/pkg/CFR-2012-title21-vol3/pdf/CFR-2012-title21-vol3-sec170-3.pdf>.
- 21 CFR 173.25 - Ion-Exchange Resins. <http://www.gpo.gov/fdsys/pkg/cfr-2010-title21-vol3/pdf/cfr-2010-title21-vol3-sec173-25.pdf>.
- 21 CFR 182.1057 – Hydrochloric Acid. <http://www.gpo.gov/fdsys/granule/cfr-2012-title21-vol3/cfr-2012-title21-vol3-sec182-1057>.
- 21 CFR 184.1742 – Sodium Carbonate. Listing of Specific Substances Affirmed As Gras. <http://www.gpo.gov/fdsys/pkg/CFR-2010-title21-vol3/pdf/CFR-2010-title21-vol3-sec184-1742.pdf>.
- 21 CFR 184.1763 – Sodium Hydroxide. <http://www.gpo.gov/fdsys/pkg/CFR-2011-title21-vol3/pdf/CFR-2011-title21-vol3-sec184-1763.pdf>.
- BioNeutra, 2008. Application for the approval of isomalto-oligosaccharide (IMO). Regulation (EC) No 258/97 of the European Parliament and of the Council of 27th January 1997 concerning novel foods and novel food ingredients. http://acnfp.food.gov.uk/sites/default/files/mnt/drupal_data/sources/files/multimedia/pdfs/isomaltodossier.pdf.
- BioNeutra, 2014. Application for an extension of use and label correction of the novel ingredients isomalto-oligosaccharide (IMO). http://acnfp.food.gov.uk/sites/default/files/mnt/drupal_data/sources/files/multimedia/pdfs/committee/acnfp/imo.pdf.
- Bouhnik Y., Raskine L., Simoneau G., Vicaut E., Neut C., Flourie B., Brouns F., Borneo FR. 2004. The capacity of nondigestible carbohydrates to stimulate fecal bifidobacteria in healthy humans: a double-blind, randomized, placebo-controlled, parallel-group, dose-response relation study. *Am. J. Clin. Nutr.* 80(6):1658-64.
- Chai YM. and Rhee SJ. 2001. Effects of dietary oligosaccharides on the blood glucose and serum lipid composition in streptozotocin-induced diabetic rats. *J. Korean Soc. Food Sci. Nutr.* 30(4):710-16 [Korean with English summary]. <http://img.kisti.re.kr/originalView/originalView.jsp>.
- Chen HL., Lu YH., Lin JJ., Ko LY. 2001. Effects of isomalto-oligosaccharides on bowel functions and indicators of nutritional status in constipated elderly men. *J. Am Coll Nutr.* 20(1):44-49.
- Chen Mo. 2008. Development of a novel probiotic-fortified energy bar containing decreased α -galactosides. <https://mospace.umsystem.edu/xmlui/bitstream/handle/10355/5662/research.pdf?sequence=3>.

Cheng MW., Chegeni M., Kim KH., Zhang G., Benmoussa M., Quezada-Calvillo R., Nichols BL., Hamaker BR. 2014. Different sucrose-isomaltase response of Caco-2 cells to glucose and maltose suggests dietary maltose sensing. *J. Clin. Biochem. Nutr.* 54(1):55-60.

Conklin KA., Yamashiro KM, Gray GM. 1975. Human intestinal sucrase-isomaltase. Identification of free sucrase and isomaltase and cleavage of the hybrid into active distinct subunits. *J. Biol. Chem.* 250(15):5735-41.

Conway PL. 2001. Prebiotics and human health: the state-of-the-art and future perspectives. *Scand J Nutr.* 45:13-21.

Crittenden RG., Playne MJ. 1996. Production, properties and applications of food-grade oligosaccharides. *Trends Food Sci Technol.* 7(11):353-61.

Cumming JH., Gibson CR., Macfarlane GT. 1989. Quantitative estimates of fermentation in the hindgut of man. *Acta. Vet. Scand.* 86, 76-82.

Cummings JH. 1997. The large intestine in nutrition and diseases. ISBN 2-930151-02-1. http://www.angelfire.com/folk/cusp/images/large_intestine.pdf.

Dahlqvist A., Suricchio S., Semenza G., and Prader A. 1963. Human intestinal disaccharides and hereditary disaccharide intolerance. The hydrolysis of sucrose, isomaltose, palatinose (isomaltulose), and 1,6- α -oligosaccharide (isomalto-oligosaccharide) preparation. *Journal of Clinical Investigation*, Vol. 42, No. 4, 556-562.

Datema R., Marshall JJ., Partington CJ., Sturgeon CM., Whelan WJ., and Woloszczuk W. 1978. Abstract of 176th American Chemical Society Meeting, Miami Beach, Fla., 38.

Day DF., Chung CH. 2004. Isomaltooligosaccharides from leuconostoc as neutraceuticals. US Patent No.: US2004/0235789. <https://docs.google.com/viewer?url=patentimages.storage.googleapis.com/pdfs/US20040235789.pdf>.

Duan SF., Zhang JZ., Zhou ZQ., Lin J. 2009. Effect of heat treatment to the stability of functional oligosaccharides. *Food and Fermentation Industries.* Vol. 35, No. 3 (Total 255)

EFSA, 2010. Scientific Opinion on the substantiation of health claims related to various food(s)/food constituents(s) and increasing numbers of gastro-intestinal microorganisms (ID 760, 761, 779, 780, 779, 1905), and decreasing potentially pathogenic gastro-intestinal microorganisms (ID 760, 761, 779, 780, 779, 1905) pursuant to Article 13(1) of Regulation (EC) No 1924/2006. *EFSA Journal* 2010, 8(10):1809. <http://www.efsa.europa.eu/en/efsajournal/doc/1809.pdf> .

EFSA. 2010. Scientific Opinion on the substantiation of health claims related to isomalto-oligosaccharides and reduction of post-prandial glycaemic responses (ID 798), and increase in the frequency of daily bowel movements (ID 800) pursuant to Article 13(1) of Regulation (EC) No 1924/2006. *EFSA Journal* 2010, 8(10):1801. <http://www.efsa.europa.eu/en/efsajournal/doc/1801.pdf> .

FDA GRN 246, 2009. GRAS Notice for Vitasugar™, an Isomalto-oligosaccharide (IMO) Mixture, for use in foods.

<http://www.fda.gov/downloads/Food/IngredientsPackagingLabeling/GRAS/NoticeInventory/UCM264134>.

FDA, 2009. Agency Response Letter GRAS Notice No. GRN000246.

<http://www.fda.gov/Food/IngredientsPackagingLabeling/GRAS/NoticeInventory/ucm154409.htm>

Flint HJ., Bayer EA., Rincon MT., Lamed R. & White BA. 2008. Polysaccharide utilization by gut bacteria: potential for new insights from genomic analysis. *Nature Reviews Microbiology* 6, 121-131.

FSA ACNFP, 2012. Initial opinion: isomalto-oligosaccharide as a novel food ingredient.

http://acnfp.food.gov.uk/sites/default/files/mnt/drupal_data/sources/files/multimedia/pdfs/imoopinion.pdf.

FSA ACNFP, 2013. Isomalto-oligosaccharide as a novel food ingredient.

http://acnfp.food.gov.uk/sites/default/files/mnt/drupal_data/sources/files/multimedia/pdfs/isomalto.pdf.

Fu P., Ran L., Zhao X. (1999). A study on the regulative effect of different dose isomaltooligosaccharides on human intestinal flora [Chinese with English summary]. *J. Acta Biologiae Experimentalis Sinica*, 1999, 11(4):198-199

G.-B. Kim, Y. M. Seo, C. H. Kim, and I. K. Paik. 2011. Effect of dietary prebiotic supplementation on the performance, intestinal microflora, and immune response of broilers. *Poultry Science*, 2011, 90, 75–82.

Ganzle MG. and Follador R. 2012. Metabolism of oligosaccharides and starch in lactobacilli: a review. *Frontiers in Microbiology*.

Gray GM., Lally BC., Conklin KA. 1979. Action of intestinal sucrose-isomaltase and its free monomers on an alpha-limit dextrin. *J. Biol Chem.* 254(13):6038-43.

Grizard D., Barthomeuf C. 1999. Non-digestible oligosaccharides used as prebiotic agents: mode of production and beneficial effects on animal and human health. *Reprod. Nutr. Dev.* 39, 563-588. <https://hal.inria.fr/file/index/docid/900326/filename/hal-00900326.pdf> .

Gu Q., Yang Y., Jiang G., Chang, G. 2003. Study on the regulative effect of isomaltooligosaccharides on human intestinal flora [Chinese with English summary]. *J. Hygiene reseach.* 32(1):56-58. <http://www.ncbi.nlm.nih.gov/pubmed/12731290>.

Health Canada, 1994. Guidelines for the Safety Assessment of Novel Foods. <http://www.hc-sc.gc.ca/fn-an/legislation/guide-ld/index-eng.php>.

Health Canada, 2009. Novel Food Decisions: Isomalto-oligosaccharides (VitaFiber™). <http://www.hc-sc.gc.ca/fn-an/gmf-agm/appro/isomalto-oligosaccharide-eng.php>.

Henningsson A., Bjorck I., Nyman M. 2001. Short-chain fatty acid formation at fermentation of

indigestible carbohydrates. Scandinavian Journal of Nutrition/Naringsforskning, 45:165-168.

Heymann H., Breitmeler D., Gunther S. 1995. Human small intestinal sucrose-isomaltase: different binding patterns for malto- and isomaltooligosaccharides. Biol. Chem. Hoppe Seyler 376(4):249-253.

Hijova E., Chmelarova A. 2007. Short chain fatty acids and colonic health. Bratisl Lek Listy, 108(8):354-358. <http://www.bmj.sk/2007/10808-06.pdf>.

Hinnebusch BF., Meng S., Wu JT., Archer SY., Hodin RA. 2002. The effects of short-chain fatty acids on human colon cancer cell phenotype are associated with histone hyperacetylation. J. Nutr. 132(5):1012-1017.

Hu Y., Ketabi A., Buchko A. and Gänzle M.G. 2013. Metabolism of isomalto-oligosaccharides by *Lactobacillus reuteri* and bifidobacteria. Letters in Applied Microbiology 57, 108-114.

Isomalto-Oligosaccharides in HLA-B27 Transgenic Rats. PLoS One. 2014; 9(11): e111717. <http://www.ncbi.nlm.nih.gov/pmc/articles/PMC4219767/>.

Jiang ZJ., Li PL., Ouyang QB. 2005. The study of the growth factors of *Bifidobacterium* sp. A04 [Chinese with English summary]. Microbiology China. 32(5):29-34.

KANEKO T., KOHMOTO T., KIKUCHI H., FUKUI F., SHIOTA M., YATAKE T., TAKAKU H., IINO H. 1992. Digestibility of Isomaltooligosaccharides by Rats and Effects on Serum Lipids. Journal of the agricultural chemical society of Japan,;VOL. 66; NO.8; 1211-1220 [Japanese with English summary]. http://astp.jst.go.jp/modules/search/index.php?page=DocumentDetail&journalId=0002-1407_66_8_Digestibility+of+Isomaltooligosaccharides+by+Rats+and+Effects+on+Serum+Lipids_.N%2FA

Kaneko T., Kohmoto T., Kikuchi H., Shiota M., Iino H., and Mitsuoka T. 1994. Effects of isomaltooligosaccharides with different degrees of polymerization on human fecal bifidobacteria. Biosci. Biotech. Biochem., 58(12), 2288-2290.

Kaneko T., Kohmoto T., Kikuchi H., Shiota M., Yatake T., Iino H., Tsuji K. 1993. Effects of isomaltooligosaccharides intake on defecation and intestinal environment in healthy Volunteers. Journal of Home Economics of Japan. 44(4):245-254. [Japanese with English summary and Tables]. https://www.jstage.jst.go.jp/article/jhej1987/44/4/44_4_245/_pdf.

Kaneko T., Yokoyama A., and Suzuki M. 1995. Digestibility characteristics of isomalto-oligosaccharides in comparison with several saccharides using the rat jejunum loop method. Biosci. Biotech. Biochem. 59 (7), 1190-1194.

Kaneko, T., Kohmoto T., Fukui F., Akiba T., Suzuki S., Hirao A., Nakatsuru S., Kanisawa M. 1990. Acute and chronic toxicity and mutagenicity studies on isomaltooligosaccharides, and the effects on peripheral blood lymphocytes and intestinal microflora. Food Hygiene and Safety Science. VOL.31; NO.5; 394-N/A.

Kerry KR., Messer M. 1967. Intestinal digestion of maltotriose in man. *Biochem. Biophys. Acta*:432-443.

Ketabi 2011b-Prebiotic activity of isomalto-oligosaccharides (thesis).

<https://era.library.ualberta.ca/public/datastream/get/uuid:1b848ea1-d05f-415c-b44e-45966b3e9e48/DS1>

Ketabi A., Dieleman L.A. and Gänzle M.G. 2011a. Influence of isomalto-oligosaccharides on intestinal microbiota in rats. *Journal of Applied Microbiology*, May 2011, 110 (5), 1297–1306,

Kihara M, Sakata T. 2002. Production of short-chain fatty acids and gas from various oligosaccharides by gut microbes of carp (*Cyprinus carpio* L.) in micro-scale batch culture. *Comp Biochem Physiol A Mol Integr Physiol.* 132(2):333-40.

<http://www.ncbi.nlm.nih.gov/pubmed/12020649>.

Kohmoto T., Fukui F., Takaku H., and Mitsuoka T. 1991. Dose-response test of isomaltooligosaccharides for increasing fecal bifisobacteria. *Agric. Biol. Chem.* 55(8), 2157-2159.

Kohmoto T., Fukui F., Takaku H., Machida Y., Arai M., and Mitsuoka T. 1988. Effect of isomalto-oligosaccharides on human fecal flora. *Bifidobacteria Microflora*, Vol. 7(2), 61-69

Kohmoto T., Tsuji K., Kaneko T., Shiota M., Fkui F., Takaku H., Nakagawa Y., Ichikawa T., Kobayashi S. 1992. Metabolism of ¹³C-isomaltooligosaccharides in healthy men. *Biosci. Biotech. Biochem.*, Vol. 56, 973-940.

Kohmoto T., Tsuji K., Kaneko T., Shiota M., Fukui F., Takaku H., Nakagawa Y., Ichikawa T., and Kobayashi. 1992. Metabolism of ¹³C-isomaltooligosaccharides in healthy men. *Biosci. Biotech. Biochem.*, 56(6):937-940.

Luo Y., Cai FQ., Zhao GX., Wu JM. 2000. *In-vitro* study of isomalto-oligosaccharide promoting the multiplication of intestinal flora. *Chinese Journal of Microecology*, 12(5), 14.

Ly SY., Lee MR., and Lee KA. 1999. Effects of cakes containing sponge oligosaccharides on blood lipids and intestinal physiology in rats. *J. Korean Soc. Food Sci. Nutr.* 28(3):619-24 [Korean with English summary]. <http://www.dbpia.co.kr/Journal/ArticleDetail/480942>.

Macfarlane GT., Gibson GR., Cummings JH. 1992. Comparison of fermentation reactions in different regions of the human colon. *J. App. Bacteriol.* 72(1):57-64.

Marco ARV., Hosana GR., Renato TN. And Rui C. 2011. Regulation of inflammation by short chain fatty acids. *Nutrition*, 3:858-876.

Mitsuoka T. 1996. Intestinal flora and human health. *Asia Pacific J. Nutr.*, 5:2-9.

Motsumoto M., Kibe R., Ooga T., Aiba Y., Kurihara S., Sawaki E., Koga Y., and Benno Y. 2012. Impact of intestinal microbiota on intestinal luminal metabolome.

<http://www.nature.com/srep/2012/120125/srep00233/pdf/srep00233.pdf>.

Mussatto SI., Mancilha IM. 2007. Non-digestible oligosaccharides: A review. *Carbohydrate*

Polymers 68:587-597.

Nakakuki T. 2002. Present status and future of functional oligosaccharide development in Japan. *Pure Appl. Chem.*, Vol. 74, No. 7, 1245-1251.

Nakakuki T. 2003. Development of functional oligosaccharides in Japan. *Trends in Glycoscience and Glycotechnology* 15(82):62-63.

https://www.jstage.jst.go.jp/article/tigg1989/15/82/15_82_57/pdf.

Noguchi, 2005. Japan Market Development Reports. *J. Food Business Line*. Vol.12, July15-Aug 15, 4. <http://apps.fas.usda.gov/gainfiles/200509/146131017.doc>.

Oku T., and Nakamura S. 2003. Comparison of digestibility and breath hydrogen gas excretion of fructo-oligosaccharide, galactosyl-sucrose and isomalto-oligosaccharide in healthy human subjects. *European Journal of Clinical Nutrition*, 57, 1150-1156.

<http://www.nature.com/ejcn/journal/v57/n9/pdf/1601666a.pdf>.

Oku T., Nakamura S. 2002. Digestion, absorption, fermentation, and metabolism of functional sugar substitutes and their available energy. *Pure Appl. Chem.* 74(7):1253-1261.

Park J., Kim M., Kang SG., Jannasch AH, Cooper B., Patterson J., and Kim CH. 2015. Short-chain fatty acids induce both effector and regulatory T cells by suppression of histone deacetylases and regulation of the mTOR-S6K pathway. *Mucosal Immunol.*, 2015 8(1):80-93. <http://www.nature.com/mi/journal/v8/n1/pdf/mi201444a.pdf>.

Patrick MS., Michael RG., Nicolai P., Monia MM., Carey AG., Mohammad BY., Jonathan NG., Wendy SG. 2013. The Microbial Metabolites, Short-Chain Fatty Acids, Regulate Colonic T_{reg} Cell Homeostasis. *Science*, 341:569-573. <http://www.sciencemag.org/content/341/6145/569.full.pdf>.

Petya Koleva, Ali Ketabi, Rosica Valcheva, Michael G. Gänzle, and Levinus A. Dieleman. 2014. Chemically Defined Diet Alters the Protective Properties of Fructo-Oligosaccharides and Isomalto-Oligosaccharides in HLA-B27 Transgenic Rats. *PLoS One*. 2014; 9(11): e111717. <http://www.ncbi.nlm.nih.gov/pmc/articles/PMC4219767/>.

Petya Koleva, Ali Ketabi, Rosica Valcheva, Michael G. Gänzle, and Levinus A. Dieleman. 2014. Chemically Defined Diet Alters the Protective Properties of Fructo-Oligosaccharides and

Qiu HD., Li ZD., Zhu QT., Chen F., Wu HS. 1999. On promoting the multiplication of bifidobacterium and influential factors [Chinese with English summary]. *J. Fuzhou University (Natural Science)*. 27(4):112-5.

Rivero-Urgell M., Santamaria-Orleans A. 2001. Oligosaccharides: Application in infant food. *Early Hum. Dev.* 2001 Nov. 65 Suppl:S43-52.

Roberfroid M. 2007b. Prebiotics: the concept revisited. *J. Nutr.* 137(3 Suppl. 2):830S-7S.

Roberfroid M., Slavin J. 2000. Nondigestible oligosaccharides. *Crit. Rev. Food Sci. Nutr.* 40(6):461-80.

Roberfroid MB. 2007. Inulin-type fructans: Functional food ingredients. *J. Nutr.* 2007, 137 (11

Suppl):2493S-2502S.

Roberfroid MB. 2007a. Inulin-type fructans: Functional food ingredients. J. Nutr. 2007, 137 (11 Suppl):2493S-2502S.

Roy CC., Kien CL., Bouthillier L., Levy E. 2006. Short-chain fatty acids: ready for prime time. Nutr. Clin. Pract. 21(4):351-66.

Rycroft C.E., Jones M.R., Gibson G.R. and Rastall R.A. 2001. A comparative in vitro evaluation of the fermentation properties of prebiotic oligosaccharides. Journal of Applied Microbiology 2001, 91, 878-887.

Sake World, Sake consumption in Japan: dismal days. #90, May 2007. http://sake-world.com/html/sw-2007_4.html.

Sako T., Matsumoto K., & Tanaka R. 1999. Recent progress on research and applications of non-digestible galacto-oligosaccharides. International Dairy Journal, 9:69-80.

Savage DC. 1986. Gastrointestinal microflora in mammalian nutrition. Annu. Rev. Nutr. 6:155-78.

Shigeharu Mori. 2009. Oligosaccharides in Japan. Presentation at FIC Conference in Shanghai, China.

Sung HY., Jeung HJ., Choi YS., Yun JW., Cho SH. 2004. Effects of Chicory Inulin and Oligosaccharides on Lipid Metabolism in Rats Fed a High-Cholesterol Diet. Han'gug sigpum yeong'yang gwahag hoeji (Journal). 33(2):305-310 [Korean with English summary]. <http://agris.fao.org/agris-search/search.do?recordID=KR2005009253>.

Topping DL. And Clifton PM. 2001. Short-chain fatty acids and human colonic function-roles of resistant starch and nonstarch polysaccharides. Physiological Reviews. 81(3):1032-1064.

Tsunehiro J., Okamoto K., Furuyama Y., Tataka T. 1999. Digestibility of the hydrogenated derivative of an isomaltooligosaccharide mixture by rats. Biosci. Biotech. Biochem. 63 (9), 1515-1521.

Tungland B.C.; Meyer D. 2002. Nondigestible oligo- and polysaccharides (dietary fiber): Their physiology and role in human health and food. Compr. Rev. Food Sci. Food Safety 3:73-92.

Voragen AGJ. 1998. Technological aspects of functional food-related carbohydrates. Trends Food Sci. Technol. 9(8-9):328-35.

Wan RF., Wang LP., Jiang SX. 2007. Effects of two oligosaccharides on the multiplication of *Lactobacilli in vitro* [Chinese with English summary]. J. Clinical Rehabilitative Tissue Engineering Research. 11(19):3768-70.

Wang HF., Lim PS., Kao MD., Chan EC., Lin LC., Wang NP. Use of isomalto-oligosaccharide in the treatment of lipid profiles and constipation in hemodialysis patients. J. Ren. Nutr. 2001. 11(2):73-9.

Wang SG., Zhang XF., Han P., Yin FK., Wang YL., Huang RP., Liu Y. 2012. Effects of

isomaltooligosaccharides on intestinal flora of mice and metabolic products thereof [Chinese with English summary]. J. Henan University of Technology (Natural Science Edition), 33(5):75-78.

Wong JM., de Souza R., Kendall CW., Emam A., Jenkins DJ. 2006. Colonic health: fermentation and short chain fatty acids. L. Clin. Gastroenterol. 40(3):235-43.

Xiao ZJ., Chen HY., Yang RD. 2005. The primary study: effect of oligosaccharides complex on proliferation of *Bifidobacteria* [Chinese with English summary]. Science and Technology of Food Industry. 7:102-106 [Chinese with English summary].

Yao JH., Ran L., Li ZG., Fu P., Yang BL., Chen ZF., Zhao X. (1999). Study on the regulative function of isomaltooligosaccharides on intestinal flora [Chinese with English summary]. Chinese Journal of Food Hygiene. 11(2):6-8 [Chinese with English summary].

APPENDIX

Appendix A1	Analytical Results for BLB [®] IMO-90 Syrup (Lot No. 14070533) (Original Chinese report is attached)	3
Appendix A2	Analytical Results for BLB [®] IMO-90 Syrup (Lot No. 14091132) (Original Chinese report is attached)	8
Appendix A3	Analytical Results for BLB [®] IMO-90 Syrup (Lot No. 14092633) (Original Chinese report is attached)	13
Appendix B1	Analytical Results for Lot BLB [®] IMO-90 Powder (Lot No. 14071631) (Original Chinese report is attached)	18
Appendix B2	Analytical Results for Lot BLB [®] IMO-90 Powder (Lot No. 14081032) (Original Chinese report is attached)	23
Appendix B3	Analytical Results for Lot BLB [®] IMO-90 Powder (Lot No. 14090231) (Original Chinese report is attached)	28
Appendix C1	Microbiological Analytical Results for BLB [®] IMO-90 Syrup (Lot No. 14070533) (Original Chinese report is attached)	33
Appendix C2	Microbiological Analytical Results for BLB [®] IMO-90 Syrup (Lot No. 14091132) (Original Chinese report is attached)	36
Appendix C3	Microbiological Analytical Results for BLB [®] IMO-90 Syrup (Lot No. 14092633) (Original Chinese report is attached)	39
Appendix D1	Microbiological Analytical Results for BLB [®] IMO-90 Powder (Lot No. 14071631) (Original Chinese report is attached)	42
Appendix D2	Microbiological Analytical Results for BLB [®] IMO-90 Powder (Lot No. 14081032) (Original Chinese report is attached)	45
Appendix D3	Microbiological Analytical Results for BLB [®] IMO-90 Powder (Lot No. 14090231) (Original Chinese report is attached)	48
Appendix E	GB/T 8885–2008 Edible Corn Starch	51
Appendix F	GB 8275–2009 Food Additive – alpha-Amylase Preparation	60
Appendix G	QB 2526–2001 Food Additive – Fungus alpha-Amylase	73
Appendix H	GB 25594–2010 Enzyme Preparations Used in Food Industry ...	83

Appendix I	QB 2525–2001 Food Additive – alpha-Glucosidase	87
Appendix J	GB 1886–2008 Food Additive – Sodium Carbonate	100
Appendix K	GB 1897–2008 Food Additive – Hydrochloric Acid	119
Appendix L	GB 5175–2008 Food Additive – Sodium Hydroxide	143
Appendix M	GB 29215–2012 Food Additive – Plant Activated Charcoal	156
Appendix N	GB/T 16579–2013 D001 Macroporous Strongly Acidic Styrene Type Cation Exchange Resins	167
Appendix O	HG 2165–91 D301 Macroporous Weakly Basic Styrene Type Anion Exchange Resins	176
Appendix P	GB/T 20881–2007 Isomaltooligosaccharide	183

Appendix A1

**Analytical Results for BLB[®] IMO-90 Syrup (Lot No. 14070533)
(Original Chinese report is attached)**

Report for Testing Results

Shandong Baolingbao Saccharides Testing Co., Ltd.

Serial No.: 201407069

NO. QR0232

Laboratory Name: Shandong Baolingbao Saccharides Testing Co., Ltd.			
Laboratory Address: 1 Outer Ring East, High-Tech. Development Zone, Yucheng, Shangdong			
Sample name: <i>Isomaltooligosaccharides</i>		Submitter: Baolingbao Biology Co., Ltd. <i>F42 Workshop</i>	
Sample No.: <i>14070533</i>		State/Color: —	
Sample quantity: <i>800 ml</i>		Test type: <i>Entrusted test</i>	
Receiving date: <i>July 4, 2014</i>		Test date: <i>July 4, 2014</i>	
Test environment : Temperature: <i>25 °C</i> Humidity: <i>50%</i>			
Test standard		<i>GB/T 20881-2007; GB 5009.12; GB/T 5009.11</i>	
Test Item	Unit	Result	Note
<i>IG₂+P+IC₃</i>	<i>%</i>	<i>46.09</i>	
<i>IMO</i>	<i>%</i>	<i>90.91</i>	
<i>Lead (Pb)</i>	<i>mg/kg</i>	<i>Absent</i>	<i>Test limit: 0.072</i>
<i>Arsenic (As)</i>	<i>mg/kg</i>	<i>Absent</i>	<i>Test limit: 0.01</i>
<i>Blank below</i>			
Stamp:			
Issue date: <i>July 17, 2014</i>			
Note: The test results in this report are only applied to the sample received.			

Compile: *Yannan Zhou*

Verify: *Shuxia Li*

Approve: *Zheng Yin*

Report for Testing Results

Shandong Baolingbao Saccharides Testing Co., Ltd.

Serial No.: 201407069

NO. QR0232

Laboratory Name: Shandong Baolingbao Saccharides Testing Co., Ltd.			
Laboratory Address: 1 Outer Ring East, High-Tech. Development Zone, Yucheng, Shangdong			
Sample name: <i>Isomaltooligosaccharides</i>		Specification: <i>90-type</i>	
Manufacturer: Baolingbao Biology Co., Ltd.		Submitter: Baolingbao Biology Co., Ltd.	
Sample No.: <i>14070533</i>		State/Color: <i>Light yellow, transparent viscous liquid.</i>	
Sample quantity: <i>800 ml</i>		Test type: <i>Entrusted test</i>	
Receiving date: <i>July 5, 2014</i>		Test date: <i>July 5, 2014</i>	
Test environment : Temperature: <i>24 °C</i> Humidity: <i>48%</i>			
Test standard	<i>GB/T 20881-2007; GB 5009.34-2003</i>		
Test Item	Unit	Result	Note
<i>pH</i>	—	<i>4.7</i>	
<i>Transmittancy</i>	%	<i>99</i>	
<i>Solid matter</i>	%	<i>75.54</i>	
<i>Sulfate Ash</i>	%	<i>0.085</i>	
<i>Sulfur dioxide</i>	g/kg	<i>0.00518</i>	
<i>Organoleptic</i>	—	<i>Light yellow, transparent viscous liquid with mild sweetness, no off-flavor, no visible impurity by normal vision.</i>	
<i>Blank below</i>			
Stamp:			
Issue date: <i>July 5, 2014</i>			
Note: The test results in this report are only applied to the sample received.			

Compile: *Chunmei Lu*

Verify: *Yanhui Fan*

Approve: *Zheng Yin*

山东保龄宝糖类检测有限公司 检测结果报告单

编号: 2014 07069

NO. QR0232

实验室名称: 山东保龄宝糖类检测有限公司			
实验室地址: 山东省禹城高新技术开发区东外环路1号			
样品名称: 低聚异麦芽糖	送检单位: 保龄宝生物股份有限公司 F42 车间		
样品编号: 14070533	物态/颜色: /		
样品数量: 800 mL	检测性质: 委托检测		
收样日期: 2014年7月4日	始检日期: 2014年7月4日		
检测环境: 温度 25 °C 湿度 50 %			
检测依据:	GB/T 20881-2007	GB 5009.12	GB/T 5009.11
检测项目	单位	结果	备注
<input checked="" type="checkbox"/> I _{G2} +P+I _{G3}	%	46.09	
<input checked="" type="checkbox"/> IMO	%	90.91	
<input checked="" type="checkbox"/> 铅	mg/kg	未检出	检出限 0.072
<input checked="" type="checkbox"/> 砷	mg/kg	未检出	检出限 0.01
<input type="checkbox"/> 以下空白			
<input type="checkbox"/>			
<input type="checkbox"/>			
<input type="checkbox"/>			
<input type="checkbox"/>			
<input type="checkbox"/>			
<input type="checkbox"/>			
<input type="checkbox"/>			
<input type="checkbox"/>			
<input type="checkbox"/>			
<input type="checkbox"/>			
<input type="checkbox"/>			
<input type="checkbox"/>			
<input type="checkbox"/>			
<input type="checkbox"/>			
<input type="checkbox"/>			
 盖章: 签发日期: 2014年7月17日			
备注: 本检测结果报告单只对来样负责			

编制: (b) (6)

审核: (b) (6)

批准: (b) (6)

山东保龄宝糖类检测有限公司 检测结果报告单

编号: 201407069

NO. QR0232

实验室名称: 山东保龄宝糖类检测有限公司			
实验室地址: 山东省禹城高新技术开发区东外环路1号			
样品名称: 低聚异麦芽糖	规格型号: 90型		
生产单位: 保龄宝生物股份有限公司	送检单位: 保龄宝生物股份有限公司		
样品编号: 14070533	形态/颜色: 浅黄色透明粘稠液体		
样品数量: 800ml	检测性质: 委托检测		
收样日期: 2014年7月5日	始检日期: 2014年7月5日		
检测环境: 温度 24℃ 湿度 48%			
检测依据:	GB/T20881-2007	GB/T5009.34-2003	
检测项目	单位	结果	备注
<input checked="" type="checkbox"/> PH	—	4.7	
<input checked="" type="checkbox"/> 透射比	%	99	
<input checked="" type="checkbox"/> 固形物	%	75.54	
<input checked="" type="checkbox"/> 硫酸灰分	%	0.085	
<input checked="" type="checkbox"/> 二氧化硫	g/kg	0.00518	
<input checked="" type="checkbox"/> 感官	—	浅黄色透明粘稠液体, 甜味柔和, 无异味, 无正常视力可见杂质.	
<input type="checkbox"/>			
<input type="checkbox"/> 以下空白			
<input type="checkbox"/>			
<input type="checkbox"/>			
<input type="checkbox"/>			
<input type="checkbox"/>			
<input type="checkbox"/>			
<input type="checkbox"/>			
<input type="checkbox"/>			
<input type="checkbox"/>			
<input type="checkbox"/>			
<input type="checkbox"/>			
<input type="checkbox"/>			
<input type="checkbox"/>			
			
盖章: _____ 签发日期: 2014年7月5日			
备注: 本检测结果报告单只对来样负责			

编制: (b) (6) 审核: (b) (6) 批准: (b) (6)

Appendix A2

**Analytical Results for BLB[®] IMO-90 Syrup (Lot No. 14091132)
(Original Chinese report is attached)**

Report for Testing Results

Shandong Baolingbao Saccharides Testing Co., Ltd.

Serial No.:

NO. QR0232

Laboratory Name: Shandong Baolingbao Saccharides Testing Co., Ltd.			
Laboratory Address: 1 Outer Ring East, High-Tech. Development Zone, Yucheng, Shangdong			
Sample name: <i>Isomaltooligosaccharides</i>		Submitter: Baolingbao Biology Co., Ltd. <i>F42 Workshop</i>	
Sample No.: <i>14091132</i>		State/Color: —	
Sample quantity: <i>800 ml</i>		Test type: <i>Entrusted test</i>	
Receiving date: <i>September 14, 2014</i>		Test date: <i>September 14, 2014</i>	
Test environment : Temperature: <i>24 °C</i> Humidity: <i>50%</i>			
Test standard		<i>GB/T 20881-2007; GB 5009.12; GB/T 5009.11</i>	
Test Item	Unit	Result	Note
<i>IG₂+P+IC₃</i>	<i>%</i>	<i>46.09</i>	
<i>IMO</i>	<i>%</i>	<i>90.23</i>	
<i>Lead (Pb)</i>	<i>mg/kg</i>	<i>Absent</i>	<i>Test limit: 0.072</i>
<i>Arsenic (As)</i>	<i>mg/kg</i>	<i>Absent</i>	<i>Test limit: 0.01</i>
<i>Blank below</i>			
Stamp:			
Issue date: <i>September 19, 2014</i>			
Note: The test results in this report are only applied to the sample received.			

Compile: *Yannan Zhou*

Verify: *Shuxia Li*

Approve: *Zheng Yin*

Report for Testing Results

Shandong Baolingbao Saccharides Testing Co., Ltd.

Serial No.: 201409212

NO. QR0232

Laboratory Name: Shandong Baolingbao Saccharides Testing Co., Ltd.			
Laboratory Address: 1 Outer Ring East, High-Tech. Development Zone, Yucheng, Shangdong			
Sample name: <i>Isomaltooligosaccharides</i>		Specification: <i>90-type</i>	
Manufacturer: Baolingbao Biology Co., Ltd.		Submitter: Baolingbao Biology Co., Ltd.	
Sample No.: <i>14091132</i>		State/Color: <i>Light yellow, transparent viscous liquid.</i>	
Sample quantity: <i>800 ml</i>		Test type: <i>Entrusted test</i>	
Receiving date: <i>September 15, 2014</i>		Test date: <i>September 15, 2014</i>	
Test environment : Temperature: <i>24 °C</i> Humidity: <i>48%</i>			
Test standard	<i>GB/T 20881-2007; GB 5009.34-2003</i>		
Test Item	Unit	Result	Note
<i>pH</i>	—	<i>4.6</i>	
<i>Transmittancy</i>	%	<i>99</i>	
<i>Solid matter</i>	%	<i>75.42</i>	
<i>Sulfate Ash</i>	%	<i>0.081</i>	
<i>Sulfur dioxide</i>	g/kg	<i>0.00650</i>	
<i>Organoleptic</i>	—	<i>Light yellow, transparent viscous liquid with mild sweetness, no off-flavor, no visible impurity by normal vision.</i>	
<i>Blank below</i>			
Stamp:			
Issue date: <i>September 15, 2014</i>			
Note: The test results in this report are only applied to the sample received.			

Compile: *Chunmei Lu*

Verify: *Yanhui Fan*

Approve: *Zheng Yin*

山东保龄宝糖类检测有限公司

检测结果报告单

编号:

NO. QR0232

实验室名称: 山东保龄宝糖类检测有限公司			
实验室地址: 山东省禹城高新技术开发区东外环路1号			
样品名称: <u>低聚异麦芽糖</u>	送检单位: 保龄宝生物股份有限公司 <u>F42车间</u>		
样品编号: <u>14091132</u>	物态/颜色: <u>/</u>		
样品数量: <u>800ml</u>	检测性质: 委托检测		
收样日期: <u>2014年9月14日</u>	始检日期: <u>2014年9月14日</u>		
检测环境: 温度 <u>24</u> °C 湿度 <u>50</u> %			
检测依据:	<u>GB/T 20881-2007</u>	<u>GB 5009.12</u>	<u>GB/T 5009.11</u>
检测项目	单位	结果	备注
<input checked="" type="checkbox"/> <u>IG2+P+IG3</u>	<u>%</u>	<u>46.09</u>	
<input checked="" type="checkbox"/> <u>IMO</u>	<u>%</u>	<u>90.23</u>	
<input checked="" type="checkbox"/> <u>铅</u>	<u>mg/kg</u>	<u>未检出</u>	<u>检出限 0.072</u>
<input checked="" type="checkbox"/> <u>砷</u>	<u>mg/kg</u>	<u>未检出</u>	<u>检出限 0.01</u>
<input type="checkbox"/> <u>以下空白</u>			
<input type="checkbox"/>			
<input type="checkbox"/>			
<input type="checkbox"/>			
<input type="checkbox"/>			
<input type="checkbox"/>			
<input type="checkbox"/>			
<input type="checkbox"/>			
<input type="checkbox"/>			
<input type="checkbox"/>			
<input type="checkbox"/>			
<input type="checkbox"/>			
<input type="checkbox"/>			
<input type="checkbox"/>			
<input type="checkbox"/>			
<input type="checkbox"/>			
<input type="checkbox"/>			
			
盖 章:			
签发日期: <u>2014年9月19日</u>			
备注: 本检测结果报告单只对来样负责			

编制: (b) (6)

审核: (b) (6)

批准:

(b) (6)

山东保龄宝糖类检测有限公司 检测结果报告单

编号: 201409212

NO. QR0232

实验室名称: 山东保龄宝糖类检测有限公司			
实验室地址: 山东省禹城高新技术开发区东外环路1号			
样品名称: 低聚异麦芽糖		规格型号: 90#	
生产单位: 保龄宝生物股份有限公司		送检单位: 保龄宝生物股份有限公司	
样品编号: 14091132		物态/颜色: 浅黄色透明粘稠液体	
样品数量: 800mL		检测性质: 委托检测	
收样日期: 2014年9月15日		始检日期: 2014年9月15日	
检测环境: 温度 24℃ 湿度 50%			
检测依据:		GB/T 20881-2007 GB/T 5009.34-2003	
检测项目	单位	结果	备注
<input checked="" type="checkbox"/> PH	—	4.6	
<input checked="" type="checkbox"/> 透射比	%	99	
<input checked="" type="checkbox"/> 固形物	%	75.42	
<input checked="" type="checkbox"/> 硫酸灰分	%	0.081	
<input checked="" type="checkbox"/> 二氧化硫	g/kg	0.00650	
<input checked="" type="checkbox"/> 感官	—	浅黄色透明粘稠液体	甜味柔和, 无异味。
<input type="checkbox"/>		无正常视力可见杂质	
<input type="checkbox"/> 以下空白			
<input type="checkbox"/>			
<input type="checkbox"/>			
<input type="checkbox"/>			
<input type="checkbox"/>			
<input type="checkbox"/>			
<input type="checkbox"/>			
<input type="checkbox"/>			
<input type="checkbox"/>			
<input type="checkbox"/>			
<input type="checkbox"/>			
 盖章: _____ 签发日期: 2014年9月15日			
备注: 本检测结果报告单只对来样负责			

编制: (b) (6)

审核: (b) (6)

批准: 尹邦 (b) (6)

Appendix A3

**Analytical Results for BLB[®] IMO-90 Syrup (Lot No. 14092633)
(Original Chinese report is attached)**

Report for Testing Results

Shandong Baolingbao Saccharides Testing Co., Ltd.

Serial No.: 201409398

NO. QR0232

Laboratory Name: Shandong Baolingbao Saccharides Testing Co., Ltd.			
Laboratory Address: 1 Outer Ring East, High-Tech. Development Zone, Yucheng, Shangdong			
Sample name: <i>Isomaltooligosaccharides</i>		Submitter: Baolingbao Biology Co., Ltd. <i>F42 Workshop</i>	
Sample No.: 14092633		State/Color: —	
Sample quantity: 800 ml		Test type: <i>Entrusted test</i>	
Receiving date: <i>September 26, 2014</i>		Test date: <i>September 26, 2014</i>	
Test environment : Temperature: 25 °C Humidity: 50%			
Test standard		<i>GB/T 20881-2007; GB 5009.12; GB/T 5009.11</i>	
Test Item	Unit	Result	Note
<i>IG₂+P+IC₃</i>	%	<i>46.01</i>	
<i>IMO</i>	%	<i>90.02</i>	
<i>Lead (Pb)</i>	<i>mg/kg</i>	<i>Absent</i>	<i>Test limit: 0.072</i>
<i>Arsenic (As)</i>	<i>mg/kg</i>	<i>Absent</i>	<i>Test limit: 0.01</i>
<i>Blank below</i>			
Stamp:			
Issue date: <i>September 30, 2014</i>			
Note: The test results in this report are only applied to the sample received.			

Compile: *Yannan Zhou*

Verify: *Shuxia Li*

Approve: *Zheng Yin*

Report for Testing Results

Shandong Baolingbao Saccharides Testing Co., Ltd.

Serial No.: 201409398

NO. QR0232

Laboratory Name: Shandong Baolingbao Saccharides Testing Co., Ltd.			
Laboratory Address: 1 Outer Ring East, High-Tech. Development Zone, Yucheng, Shangdong			
Sample name: <i>Isomaltooligosaccharides</i>		Specification: <i>90-type</i>	
Manufacturer: Baolingbao Biology Co., Ltd.		Submitter: Baolingbao Biology Co., Ltd.	
Sample No.: <i>14092633</i>		State/Color: <i>Light yellow, transparent viscous liquid.</i>	
Sample quantity: <i>800 ml</i>		Test type: <i>Entrusted test</i>	
Receiving date: <i>September 27, 2014</i>		Test date: <i>September 27, 2014</i>	
Test environment : Temperature: <i>23 °C</i> Humidity: <i>50%</i>			
Test standard	<i>GB/T 20881-2007; GB 5009.34-2003</i>		
Test Item	Unit	Result	Note
<i>pH</i>	—	<i>5.0</i>	
<i>Transmittancy</i>	%	<i>99</i>	
<i>Solid matter</i>	%	<i>75.35</i>	
<i>Sulfate Ash</i>	%	<i>0.069</i>	
<i>Sulfur dioxide</i>	g/kg	<i>0.00712</i>	
<i>Organoleptic</i>	—	<i>Light yellow, transparent viscous liquid with mild sweetness, no off-flavor, no visible impurity by normal vision.</i>	
<i>Blank below</i>			
Stamp:			
Issue date: <i>September 27, 2014</i>			
Note: The test results in this report are only applied to the sample received.			

Compile: *Chunmei Lu*

Verify: *Yanhui Fan*

Approve: *Zheng Yin*

山东保龄宝糖类检测有限公司 检测结果报告单

编号: 201409398

NO. QR0232

实验室名称: 山东保龄宝糖类检测有限公司			
实验室地址: 山东省禹城高新技术开发区东外环路1号			
样品名称: 低聚异麦芽糖	送检单位: 保龄宝生物股份有限公司 F42车间		
样品编号: 14092633	物态/颜色: /		
样品数量: 800mL	检测性质: 委托检测		
收样日期: 2014年9月26日	始检日期: 2014年9月26日		
检测环境: 温度 25℃ 湿度 50%			
检测依据:	GB/T 20881-2007	GB 5009.12	GB/T 5009.11
检测项目	单位	结果	备注
<input checked="" type="checkbox"/> IG₂+P+IG₃	%	46.01	
<input checked="" type="checkbox"/> IMO	%	90.02	
<input checked="" type="checkbox"/> 铅	mg/kg	未检出	检出限 0.072
<input checked="" type="checkbox"/> 砷	mg/kg	未检出	检出限 0.01
<input type="checkbox"/> 以下空白			
<input type="checkbox"/>			
<input type="checkbox"/>			
<input type="checkbox"/>			
<input type="checkbox"/>			
<input type="checkbox"/>			
<input type="checkbox"/>			
<input type="checkbox"/>			
<input type="checkbox"/>			
<input type="checkbox"/>			
<input type="checkbox"/>			
<input type="checkbox"/>			
<input type="checkbox"/>			
<input type="checkbox"/>			
<input type="checkbox"/>			
<input type="checkbox"/>			
<input type="checkbox"/>			
<input type="checkbox"/>			
 盖章: 签发日期: 2014年9月30日			
备注: 本检测结果报告单只对来样负责			

编制: (b) (6)

审核: (b) (6)

批准: (b) (6)

山东保龄宝糖类检测有限公司

检测结果报告单

编号: 201409398

NO. QR0232

实验室名称: 山东保龄宝糖类检测有限公司			
实验室地址: 山东省禹城高新技术开发区东外环路1号			
样品名称: 低聚异麦芽糖	规格型号: 90型		
生产单位: 保龄宝生物股份有限公司	送检单位: 保龄宝生物股份有限公司		
样品编号: 14092633	物态/颜色: 浅黄色透明粘稠液体		
样品数量: 800mL	检测性质: 委托检测		
收样日期: 2014年9月27日	始检日期: 2014年9月27日		
检测环境: 温度 23℃ 湿度 50%			
检测依据:	GB/T20881-2007	GB/T509.34-2003	
检测项目	单位	结果	备注
<input checked="" type="checkbox"/> PH	—	5.0	
<input checked="" type="checkbox"/> 透射比	%	99	
<input checked="" type="checkbox"/> 固形物	%	75.35	
<input checked="" type="checkbox"/> 硫酸灰分	%	0.069	
<input checked="" type="checkbox"/> 二氧化硫	g/kg	0.00712	
<input checked="" type="checkbox"/> 感官	—	浅黄色透明粘稠液体	甜味柔和, 无异味
<input type="checkbox"/>		无正常视力可见杂质	
<input type="checkbox"/> 以下空白			
<input type="checkbox"/>			
<input type="checkbox"/>			
<input type="checkbox"/>			
<input type="checkbox"/>			
<input type="checkbox"/>			
<input type="checkbox"/>			
<input type="checkbox"/>			
<input type="checkbox"/>			
<input type="checkbox"/>			
			
签发日期: 2014年9月27日			
备注: 本检测结果报告单只对来样负责			

编制: (b) (6)

审核: (b) (6)

批准:

(b) (6)

Appendix B1

**Analytical Results for Lot BLB[®] IMO-90 Powder (Lot No. 14071631)
(Original Chinese report is attached)**

Report for Testing Results

Shandong Baolingbao Saccharides Testing Co., Ltd.

Serial No.: 201407273

NO. QR0232

Laboratory Name: Shandong Baolingbao Saccharides Testing Co., Ltd.			
Laboratory Address: 1 Outer Ring East, High-Tech. Development Zone, Yucheng, Shangdong			
Sample name: <i>Isomaltooligosaccharides</i>		Submitter: Baolingbao Biology Co., Ltd. <i>Oligosaccharide Workshop</i>	
Sample No.: 14071631		State/Color: —	
Sample quantity: 500 g		Test type: <i>Entrusted test</i>	
Receiving date: <i>July 17, 2014</i>		Test date: <i>July 17, 2014</i>	
Test environment : Temperature: 26 °C Humidity: 48%			
Test standard		<i>GB/T 20881-2007; GB 5009.12; GB/T 5009.11</i>	
Test Item	Unit	Result	Note
<i>IG₂+P+IC₃</i>	%	<i>45.80</i>	
<i>IMO</i>	%	<i>90.75</i>	
<i>Lead (Pb)</i>	<i>mg/kg</i>	<i>Absent</i>	<i>Test limit: 0.072</i>
<i>Arsenic (As)</i>	<i>mg/kg</i>	<i>Absent</i>	<i>Test limit: 0.01</i>
<i>Blank below</i>			
Stamp:			
Issue date: <i>July 18, 2014</i>			
Note: The test results in this report are only applied to the sample received.			

Compile: *Yannan Zhou*

Verify: *Shuxia Li*

Approve: *Zheng Yin*

Report for Testing Results

Shandong Baolingbao Saccharides Testing Co., Ltd.

Serial No.: 201407273

NO. QR0232

Laboratory Name: Shandong Baolingbao Saccharides Testing Co., Ltd.			
Laboratory Address: 1 Outer Ring East, High-Tech. Development Zone, Yucheng, Shangdong			
Sample name: <i>Isomaltooligosaccharides</i>		Specification: <i>90-type</i>	
Manufacturer: Baolingbao Biology Co., Ltd.		Submitter: Baolingbao Biology Co., Ltd.	
Sample No.: <i>14071631</i>		State/Color: <i>White powder</i>	
Sample quantity: <i>500 g</i>		Test type: <i>Entrusted test</i>	
Receiving date: <i>July 17, 2014</i>		Test date: <i>July 17, 2014</i>	
Test environment : Temperature: <i>25 °C</i> Humidity: <i>45%</i>			
Test standard		<i>GB/T 20881-2007; GB 5009.34-2003</i>	
Test Item	Unit	Result	Note
<i>pH</i>	—	<i>4.7</i>	
<i>Moisture</i>	%	<i>4.3</i>	
<i>Solubility</i>	%	<i>99.8</i>	
<i>Sulfate Ash</i>	%	<i>0.085</i>	
<i>Sulfur dioxide</i>	g/kg	<i>0.00641</i>	
<i>Organoleptic</i>	—	<i>White and amorphous powder with mild sweetness, no off-flavor, no visible impurity by normal vision.</i>	
<i>Blank below</i>			
Stamp:			
Issue date: <i>July 17, 2014</i>			
Note: The test results in this report are only applied to the sample received.			

Compile: *Gaofei Zhai*

Verify: *Yanhui Fan*

Approve: *Zheng Yin*

山东保龄宝糖类检测有限公司 检测结果报告单

编号: 201407273

NO. QR0232

实验室名称: 山东保龄宝糖类检测有限公司			
实验室地址: 山东省禹城高新技术开发区东外环路1号			
样品名称: 低聚异麦芽糖	送检单位: 保龄宝生物股份有限公司 低聚糖车间		
样品编号: 14071631	物态/颜色: /		
样品数量: 500g	检测性质: 委托检测		
收样日期: 2014年7月17日	始检日期: 2014年7月17日		
检测环境: 温度 26℃ 湿度 48%			
检测依据:	GB/T 20881-2007	GB 5009.12	GB/T 5009.11
检测项目	单位	结果	备注
<input checked="" type="checkbox"/> I _{G2} +P+I _{G3}	%	45.80	
<input checked="" type="checkbox"/> IMO	%	90.75	
<input checked="" type="checkbox"/> 铅	mg/kg	未检出	检出限 0.072
<input checked="" type="checkbox"/> 砷	mg/kg	未检出	检出限 0.01
<input type="checkbox"/> 以下空白			
<input type="checkbox"/>			
<input type="checkbox"/>			
<input type="checkbox"/>			
<input type="checkbox"/>			
<input type="checkbox"/>			
<input type="checkbox"/>			
<input type="checkbox"/>			
<input type="checkbox"/>			
<input type="checkbox"/>			
<input type="checkbox"/>			
<input type="checkbox"/>			
<input type="checkbox"/>			
<input type="checkbox"/>			
<input type="checkbox"/>			
<input type="checkbox"/>			
<input type="checkbox"/>			
			
签发日期: 2014年7月18日			
备注: 本检测结果报告单只对来样负责			

编制: (b) (6)

审核: (b) (6)

批准: (b) (6)

山东保龄宝糖类检测有限公司 检测结果报告单

编号: 201407273

NO. QR0232

实验室名称: 山东保龄宝糖类检测有限公司			
实验室地址: 山东省禹城高新技术开发区东外环路1号			
样品名称: 低聚异麦芽糖		规格型号: 90型	
生产单位: 保龄宝生物股份有限公司		送检单位: 保龄宝生物股份有限公司	
样品编号: 14071631		物态/颜色: 白色粉末	
样品数量: 500g		检测性质: 委托检测	
收样日期: 2014年7月17日		始检日期: 2014年7月17日	
检测环境: 温度 25℃ 湿度 45%			
检测依据: GB/T 20881-2007 GB/T 5009.34-2003			
检测项目	单位	结果	备注
<input checked="" type="checkbox"/> pH	—	4.7	
<input checked="" type="checkbox"/> 水分	%	4.3	
<input checked="" type="checkbox"/> 溶解度	%	99.8	
<input checked="" type="checkbox"/> 硫酸灰分	%	0.085	
<input checked="" type="checkbox"/> 二氧化硫	g/kg	0.00641	
<input checked="" type="checkbox"/> 感官	—	白色无定形粉末, 甜味柔和, 无异味, 无正常视力可见杂质	
<input type="checkbox"/>			
<input type="checkbox"/> 以下空白			
<input type="checkbox"/>			
<input type="checkbox"/>			
<input type="checkbox"/>			
<input type="checkbox"/>			
<input type="checkbox"/>			
<input type="checkbox"/>			
<input type="checkbox"/>			
<input type="checkbox"/>			
<input type="checkbox"/>			
<input type="checkbox"/>			
			
签发日期: 2014年7月17日			
备注: 本检测结果报告单只对来样负责			

编制: (b) (6)

审核: (b) (6)

批准: (b) (6)

Appendix B2

**Analytical Results for Lot BLB[®] IMO-90 Powder (Lot No. 14081032)
(Original Chinese report is attached)**

Report for Testing Results

Shandong Baolingbao Saccharides Testing Co., Ltd.

Serial No.: 291408183

NO. QR0232

Laboratory Name: Shandong Baolingbao Saccharides Testing Co., Ltd.			
Laboratory Address: 1 Outer Ring East, High-Tech. Development Zone, Yucheng, Shangdong			
Sample name: <i>Isomaltooligosaccharides 90P</i>		Submitter: Baolingbao Biology Co., Ltd. <i>Oligosaccharide Workshop</i>	
Sample No.: <i>14081032</i>		State/Color: —	
Sample quantity: <i>500 g</i>		Test type: <i>Entrusted test</i>	
Receiving date: <i>August 11, 2014</i>		Test date: <i>August 11, 2014</i>	
Test environment : Temperature: <i>25 °C</i> Humidity: <i>49%</i>			
Test standard		<i>GB/T 20881-2007; GB 5009.12; GB/T 5009.11</i>	
Test Item	Unit	Result	Note
<i>IG₂+P+IC₃</i>	<i>%</i>	<i>46.27</i>	
<i>IMO</i>	<i>%</i>	<i>90.04</i>	
<i>Lead (Pb)</i>	<i>mg/kg</i>	<i>Absent</i>	<i>Test limit: 0.072</i>
<i>Arsenic (As)</i>	<i>mg/kg</i>	<i>Absent</i>	<i>Test limit: 0.01</i>
<i>Blank below</i>			
Stamp:			
Issue date: <i>August 15, 2014</i>			
Note: The test results in this report are only applied to the sample received.			

Compile: *Yannan Zhou*

Verify: *Shuxia Li*

Approve: *Zheng Yin*

Report for Testing Results

Shandong Baolingbao Saccharides Testing Co., Ltd.

Serial No.: 201408183

NO. QR0232

Laboratory Name: Shandong Baolingbao Saccharides Testing Co., Ltd.			
Laboratory Address: 1 Outer Ring East, High-Tech. Development Zone, Yucheng, Shangdong			
Sample name: <i>Isomaltooligosaccharides</i>		Specification: <i>90-type</i>	
Manufacturer: Baolingbao Biology Co., Ltd.		Submitter: Baolingbao Biology Co., Ltd.	
Sample No.: <i>14081032</i>		State/Color: <i>White powder</i>	
Sample quantity: <i>500 g</i>		Test type: <i>Entrusted test</i>	
Receiving date: <i>August 11, 2014</i>		Test date: <i>August 11, 2014</i>	
Test environment : Temperature: <i>25 °C</i> Humidity: <i>45%</i>			
Test standard		<i>GB/T 20881-2007; GB 5009.34-2003</i>	
Test Item	Unit	Result	Note
<i>pH</i>	—	<i>4.6</i>	
<i>Moisture</i>	%	<i>4.0</i>	
<i>Solubility</i>	%	<i>99.8</i>	
<i>Sulfate Ash</i>	%	<i>0.078</i>	
<i>Sulfur dioxide</i>	g/kg	<i>0.00579</i>	
<i>Organoleptic</i>	—	<i>White and amorphous powder with mild sweetness, no off-flavor, no visible impurity by normal vision.</i>	
<i>Blank below</i>			
Stamp:			
Issue date: <i>August 11, 2014</i>			
Note: The test results in this report are only applied to the sample received.			

Compile: *Chunmei Lu*

Verify:

Approve: *Zheng Yin*

山东保龄宝糖类检测有限公司 检测结果报告单

编号: 201408183

NO. QR0232

实验室名称: 山东保龄宝糖类检测有限公司			
实验室地址: 山东省禹城高新技术开发区东外环路1号			
样品名称: 低聚异麦芽糖 90P	送检单位: 保龄宝生物股份有限公司 低聚糖车间		
样品编号: 14081032	物态/颜色: /		
样品数量: 500g	检测性质: 委托检测		
收样日期: 2014年8月11日	始检日期: 2014年8月11日		
检测环境: 温度 25℃ 湿度 49%			
检测依据:	GB/T 20881-2007	GB 5009.12	GB/T 5009.11
检测项目	单位	结果	备注
<input checked="" type="checkbox"/> IF ₂ +P+IF ₃	%	46.27	
<input checked="" type="checkbox"/> IMO	%	90.04	
<input checked="" type="checkbox"/> 铅	mg/kg	未检出	检出限 0.072
<input checked="" type="checkbox"/> 砷	mg/kg	未检出	检出限 0.01
<input type="checkbox"/> 以下空白			
<input type="checkbox"/>			
<input type="checkbox"/>			
<input type="checkbox"/>			
<input type="checkbox"/>			
<input type="checkbox"/>			
<input type="checkbox"/>			
<input type="checkbox"/>			
<input type="checkbox"/>			
<input type="checkbox"/>			
<input type="checkbox"/>			
<input type="checkbox"/>			
<input type="checkbox"/>			
<input type="checkbox"/>			
<input type="checkbox"/>			
<input type="checkbox"/>			
<input type="checkbox"/>			
 盖章: _____ 签发日期: 2014年8月15日			
备注: 本检测结果报告单只对来样负责			

编制: (b) (6)

审核: (b) (6)

批准: (b) (6)

山东保龄宝糖类检测有限公司

检测结果报告单

编号: 201408183

NO. QR0232

实验室名称: 山东保龄宝糖类检测有限公司			
实验室地址: 山东省禹城高新技术开发区东外环路1号			
样品名称: 低聚异麦芽糖		规格型号: 90型	
生产单位: 保龄宝生物股份有限公司		送检单位: 保龄宝生物股份有限公司	
样品编号: 14081032		物态/颜色: 白色粉末	
样品数量: 500g		检测性质: 委托检测	
收样日期: 2014年8月11日		始检日期: 2014年8月11日	
检测环境: 温度 25℃ 湿度 45%			
检测依据:		GB/T20881-2007 GB/T5009.34-2003	
检测项目	单位	结果	备注
<input checked="" type="checkbox"/> PH	—	4.6	
<input checked="" type="checkbox"/> 水分	%	4.0	
<input checked="" type="checkbox"/> 溶解度	%	99.8	
<input checked="" type="checkbox"/> 硫酸灰分	%	0.078	
<input checked="" type="checkbox"/> 二氧化硫	g/kg	0.00579	
<input checked="" type="checkbox"/> 感官	—	白色无定形粉末, 甜味柔和, 无异味, 无正常视力可见杂质.	
<input type="checkbox"/>			
<input type="checkbox"/> 以下空白			
<input type="checkbox"/>			
<input type="checkbox"/>			
<input type="checkbox"/>			
<input type="checkbox"/>			
<input type="checkbox"/>			
<input type="checkbox"/>			
<input type="checkbox"/>			
<input type="checkbox"/>			
<input type="checkbox"/>			
<input type="checkbox"/>			
 盖章: _____ 签发日期: 2014年8月11日			
备注: 本检测结果报告单只对来样负责			

编制: (b) (6)

审核: (b) (6)

批准: (b) (6)

Appendix B3

**Analytical Results for Lot BLB[®] IMO-90 Powder (Lot No. 14090231)
(Original Chinese report is attached)**

Report for Testing Results

Shandong Baolingbao Saccharides Testing Co., Ltd.

Serial No.: *201409038*

NO. QR0232

Laboratory Name: Shandong Baolingbao Saccharides Testing Co., Ltd.			
Laboratory Address: 1 Outer Ring East, High-Tech. Development Zone, Yucheng, Shangdong			
Sample name: <i>Isomaltooligosaccharides</i>		Submitter: Baolingbao Biology Co., Ltd. <i>Oligosaccharide Workshop</i>	
Sample No.: <i>14090231</i>		State/Color: —	
Sample quantity: <i>500 g</i>		Test type: <i>Entrusted test</i>	
Receiving date: <i>September 3, 2014</i>		Test date: <i>September 3, 2014</i>	
Test environment : Temperature: <i>26 °C</i> Humidity: <i>50%</i>			
Test standard		<i>GB/T 20881-2007; GB 5009.12; GB/T 5009.11</i>	
Test Item	Unit	Result	Note
<i>IG₂+P+IC₃</i>	%	<i>45.61</i>	
<i>IMO</i>	%	<i>90.02</i>	
<i>Lead (Pb)</i>	<i>mg/kg</i>	<i>Absent</i>	<i>Test limit: 0.072</i>
<i>Arsenic (As)</i>	<i>mg/kg</i>	<i>Absent</i>	<i>Test limit: 0.01</i>
<i>Blank below</i>			
Stamp:			
Issue date: <i>September 14, 2014</i>			
Note: The test results in this report are only applied to the sample received.			

Compile: *Yannan Zhou*

Verify: *Shuxia Li*

Approve: *Zheng Yin*

Report for Testing Results

Shandong Baolingbao Saccharides Testing Co., Ltd.

Serial No.: 201409038

NO. QR0232

Laboratory Name: Shandong Baolingbao Saccharides Testing Co., Ltd.			
Laboratory Address: 1 Outer Ring East, High-Tech. Development Zone, Yucheng, Shangdong			
Sample name: <i>Isomaltooligosaccharides</i>		Specification: <i>90-type</i>	
Manufacturer: Baolingbao Biology Co., Ltd.		Submitter: Baolingbao Biology Co., Ltd.	
Sample No.: <i>14090231</i>		State/Color: <i>White powder</i>	
Sample quantity: <i>500 g</i>		Test type: <i>Entrusted test</i>	
Receiving date: <i>September 3, 2014</i>		Test date: <i>September 3, 2014</i>	
Test environment : Temperature: <i>26 °C</i> Humidity: <i>50%</i>			
Test standard		<i>GB/T 20881-2007; GB 5009.34-2003</i>	
Test Item	Unit	Result	Note
<i>pH</i>	—	<i>4.7</i>	
<i>Moisture</i>	%	<i>4.4</i>	
<i>Solubility</i>	%	<i>99.7</i>	
<i>Sulfate Ash</i>	%	<i>0.084</i>	
<i>Sulfur dioxide</i>	g/kg	<i>0.00708</i>	
<i>Organoleptic</i>	—	<i>White and amorphous powder with mild sweetness, no off-flavor, no visible impurity by normal vision.</i>	
<i>Blank below</i>			
Stamp:			
Issue date: <i>September 3, 2014</i>			
Note: The test results in this report are only applied to the sample received.			

Compile: *Gaofei Zhai*

Verify: *Yanhui Fan*

Approve: *Zheng Yin*

山东保龄宝糖类检测有限公司 检测结果报告单

编号: 201409038

NO. QR0232

实验室名称: 山东保龄宝糖类检测有限公司			
实验室地址: 山东省禹城高新技术开发区东外环路1号			
样品名称: 低聚异麦芽糖	送检单位: 保龄宝生物股份有限公司 低聚糖车间		
样品编号: 14090231	物态/颜色: /		
样品数量: 500g	检测性质: 委托检测		
收样日期: 2014年9月3日	始检日期: 2014年9月3日		
检测环境: 温度 26℃ 湿度 50%			
检测依据:	GB/T 20881-2007	GB 5009.12	GB/T 5009.11
检测项目	单位	结果	备注
<input checked="" type="checkbox"/> 淀粉+P+淀粉	%	45.61	
<input checked="" type="checkbox"/> 蛋白	%	90.02	
<input checked="" type="checkbox"/> 铅	mg/kg	未检出	检出限 0.072
<input checked="" type="checkbox"/> 砷	mg/kg	未检出	检出限 0.01
<input type="checkbox"/> 以下空白			
<input type="checkbox"/>			
<input type="checkbox"/>			
<input type="checkbox"/>			
<input type="checkbox"/>			
<input type="checkbox"/>			
<input type="checkbox"/>			
<input type="checkbox"/>			
<input type="checkbox"/>			
<input type="checkbox"/>			
<input type="checkbox"/>			
<input type="checkbox"/>			
<input type="checkbox"/>			
<input type="checkbox"/>			
盖章:			
签发日期: 2014年9月14日			
备注: 本检测结果报告单只对来样负责			

编制: (b) (6)

审核: (b) (6)

批准: (b) (6)

山东保龄宝糖类检测有限公司

检测结果报告单

编号: 201409038

NO. QR0232

实验室名称: 山东保龄宝糖类检测有限公司			
实验室地址: 山东省禹城高新技术开发区东外环路1号			
样品名称: 低聚异麦芽糖		规格型号: 90型	
生产单位: 保龄宝生物股份有限公司		送检单位: 保龄宝生物股份有限公司	
样品编号: 14090231		物态/颜色: 白色粉末	
样品数量: 500g		检测性质: 委托检测	
收样日期: 2014年9月3日		始检日期: 2014年9月3日	
检测环境: 温度 26℃ 湿度 50%			
检测依据:		GB/T 20881-2007 GB/T 5009.34-2003	
检测项目	单位	结果	备注
<input checked="" type="checkbox"/> PH	—	4.7	
<input checked="" type="checkbox"/> 水分	%	44	
<input checked="" type="checkbox"/> 溶解度	%	99.7	
<input checked="" type="checkbox"/> 硫酸灰分	%	0.084	
<input checked="" type="checkbox"/> 二氧化硫	g/kg	0.00708	
<input checked="" type="checkbox"/> 感官	—	白色无定形粉末, 甜味柔和, 无异味, 无正常视力可见杂质	
<input type="checkbox"/>			
<input type="checkbox"/> 以下空白			
<input type="checkbox"/>			
<input type="checkbox"/>			
<input type="checkbox"/>			
<input type="checkbox"/>			
<input type="checkbox"/>			
<input type="checkbox"/>			
<input type="checkbox"/>			
<input type="checkbox"/>			
<input type="checkbox"/>			
<input type="checkbox"/>			
<input type="checkbox"/>			
			
签发日期: 2014年9月3日			
备注: 本检测结果报告单只对来样负责			

编制: (b) (6)

审核: (b) (6)

批准: (b) (6)

Appendix C1

**Microbiological Analytical Results for BLB[®] IMO-90 Syrup
(Lot No. 14070533) (Original Chinese report is attached)**

Report for Testing Results

Shandong Baolingbao Saccharides Testing Co., Ltd.

Serial No.: **201407069**

NO. **QR0232**

Laboratory Name: Shandong Baolingbao Saccharides Testing Co., Ltd.

Laboratory Address: 1 Outer Ring East, High-Tech. Development Zone, Yucheng, Shangdong

Sample name: ***Isomaltooligosaccharides*** Specification: ***90-type***

Manufacturer: Baolingbao Biology Co., Ltd. Submitter: Baolingbao Biology Co., Ltd.
Oligosaccharide Workshop

Sample No.: ***14070533*** State/Color: ***Light yellow and transparent viscous liquid***

Sample quantity: ***100 g*** Test type: ***Entrusted test***

Receiving date: ***July 5, 2014*** Test date: ***July 5, 2014***

Test environment : Temperature: ***20 °C*** Humidity: ***50%***

Test Item	Unit	Result	Test Method
<i>Aerobic plate count</i>	<i>cfu/g</i>	<i><10</i>	GB 4789.2
<i>Coliform</i>	<i>MPN/g</i>	<i><0.3</i>	GB 4789.3
<i>Mold</i>	<i>cfu/g</i>		GB 4789.15
<i>Yeast</i>	<i>cfu/g</i>		GB 4789.15
<i>Salmonella</i>	<i>/25g</i>	<i>Absent</i>	GB 4789.4
<i>Staphylococcus aureus</i>	<i>/25g</i>		GB 4789.10
<i>Enterobacter sakazakii</i>	<i>/100g</i>		GB 4789.40
<i>Blank below</i>			

Stamp:

Issue date: ***July 9, 2014***

Note: The test results in this report are only applied to the sample received.

Examiner: ***Zhenyuan Wu***

Verify: ***Hengyuan Lv***

Zheng Yin

山东保龄宝糖类检测有限公司 检测结果报告单

NO.QR0230

编号: 201407069

实验室名称: 山东保龄宝糖类检测有限公司

实验室地址: 山东省禹城高新技术开发区东外环路1号

样品名称: 低聚异麦芽糖

规格型号: 90型

生产单位: 保龄宝生物股份有限公司 低聚糖车间

送检单位: 保龄宝生物股份有限公司

样品编号: 14070533

物态/颜色: 浅黄色、透明的粘稠液体

样品数量: 100g

检测性质: 委托检测

收样日期: 14年7月5日

始检日期: 14年7月5日

检测环境: 温度 20℃ 湿度 50%

检测项目	单位	结果	检测依据
<input checked="" type="checkbox"/> 菌落总数	cfu/g	10	GB 4789.2
<input checked="" type="checkbox"/> 大肠菌群	MPN/g	<0.3	GB 4789.3
<input type="checkbox"/> 霉菌	cfu/g		GB 4789.15
<input type="checkbox"/> 酵母菌	cfu/g		GB 4789.15
<input checked="" type="checkbox"/> 沙门氏菌	/25g	未检出	GB 4789.4
<input type="checkbox"/> 金黄色葡萄球菌	/25g		GB 4789.10
<input type="checkbox"/> 阪崎肠杆菌	/100g		GB 4789.40
<input type="checkbox"/> 以下空白			
<input type="checkbox"/>			
<input type="checkbox"/>			
<input type="checkbox"/>			
<input type="checkbox"/>			
<input type="checkbox"/>			
<input type="checkbox"/>			
<input type="checkbox"/>			
<input type="checkbox"/>			
<input type="checkbox"/>			
<input type="checkbox"/>			
<input type="checkbox"/>			
<input type="checkbox"/>			



签发日期: 14年7月9日

备注: 本检测结果报告单只对来样负责

主检: (b) (6)

审核: (b) (6)

(b) (6)

Appendix C2

**Microbiological Analytical Results for BLB[®] IMO-90 Syrup
(Lot No. 14091132) (Original Chinese report is attached)**

Report for Testing Results

Shandong Baolingbao Saccharides Testing Co., Ltd.

Serial No.: 201409212

NO. QR0230

Laboratory Name: Shandong Baolingbao Saccharides Testing Co., Ltd.

Laboratory Address: 1 Outer Ring East, High-Tech. Development Zone, Yucheng, Shangdong

Sample name: *Isomaltooligosaccharides*

Specification: *90-type*

Manufacturer: Baolingbao Biology Co., Ltd.
Oligosaccharide Workshop

Submitter: Baolingbao Biology Co., Ltd.

Sample No.: 14091132

State/Color: *Light yellow and transparent viscous liquid*

Sample quantity: 100 g

Test type: *Entrusted test*

Receiving date: *September 15, 2014*

Test date: *September 15, 2014*

Test environment : Temperature: 21 °C Humidity: 51%

Test Item	Unit	Result	Test Method
<i>Aerobic plate count</i>	<i>cfu/g</i>	<i><10</i>	GB 4789.2
<i>Coliform</i>	<i>MPN/g</i>	<i><0.3</i>	GB 4789.3
<i>Mold</i>	<i>cfu/g</i>		GB 4789.15
<i>Yeast</i>	<i>cfu/g</i>		GB 4789.15
<i>Salmonella</i>	<i>/25g</i>	<i>Absent</i>	GB 4789.4
<i>Staphylococcus aureus</i>	<i>/25g</i>		GB 4789.10
<i>Enterobacter sakazakii</i>	<i>/100g</i>		GB 4789.40
<i>Blank below</i>			

Stamp:

Issue date: *September 19, 2014*

Note: The test results in this report are only applied to the sample received.

Examiner: *Zhenyuan Wu*

Verify: *Hengyuan Lv*

Zheng Yin

山东保龄宝糖类检测有限公司

检测结果报告单

NO.QR0230

编号: 201409212

实验室名称: 山东保龄宝糖类检测有限公司

实验室地址: 山东省禹城高新技术开发区东外环路1号

样品名称: 低聚异麦芽糖 规格型号: 90型

生产单位: 保龄宝生物股份有限公司 低聚糖车间 送检单位: 保龄宝生物股份有限公司

样品编号: 14091132 物态/颜色: 浅黄色、透明的粘稠液体

样品数量: 100g 检测性质: 委托检测

收样日期: 14年9月15日 始检日期: 14年9月15日

检测环境: 温度 21℃ 湿度 51%

检测项目	单位	结果	检测依据
<input checked="" type="checkbox"/> 菌落总数	cfu/g	<10	GB 4789.2
<input checked="" type="checkbox"/> 大肠菌群	MPN/g	<0.3	GB 4789.3
<input type="checkbox"/> 霉菌	cfu/g		GB 4789.15
<input type="checkbox"/> 酵母菌	cfu/g		GB 4789.15
<input checked="" type="checkbox"/> 沙门氏菌	/25g	未检出	GB 4789.4
<input type="checkbox"/> 金黄色葡萄球菌	/25g		GB 4789.10
<input type="checkbox"/> 阪崎肠杆菌	/100g		GB 4789.40
<input type="checkbox"/> 以下空白			
<input type="checkbox"/>			
<input type="checkbox"/>			
<input type="checkbox"/>			
<input type="checkbox"/>			
<input type="checkbox"/>			
<input type="checkbox"/>			
<input type="checkbox"/>			
<input type="checkbox"/>			
<input type="checkbox"/>			
<input type="checkbox"/>			
<input type="checkbox"/>			



 盖章:

 签发日期: 14年9月19日

备注: 本检测结果报告单只对来样负责

主检: (b) (6) 审核: (b) (6)

(b) (6)

Appendix C3

**Microbiological Analytical Results for BLB[®] IMO-90 Syrup
(Lot No. 14092633) (Original Chinese report is attached)**

Report for Testing Results

Shandong Baolingbao Saccharides Testing Co., Ltd.

Serial No.: **201409398**

NO. QR0230

Laboratory Name: Shandong Baolingbao Saccharides Testing Co., Ltd.

Laboratory Address: 1 Outer Ring East, High-Tech. Development Zone, Yucheng, Shangdong

Sample name: ***Isomaltooligosaccharides***

Specification: ***90-type***

Manufacturer: Baolingbao Biology Co., Ltd.
Oligosaccharide Workshop

Submitter: Baolingbao Biology Co., Ltd.

Sample No.: **14092633**

State/Color: ***Light yellow and transparent viscous liquid***

Sample quantity: **100 g**

Test type: ***Entrusted test***

Receiving date: ***September 27, 2014***

Test date: ***September 27, 2014***

Test environment : Temperature: **20 °C** Humidity: **51%**

Test Item	Unit	Result	Test Method
<i>Aerobic plate count</i>	<i>cfu/g</i>	<i><10</i>	GB 4789.2
<i>Coliform</i>	<i>MPN/g</i>	<i><0.3</i>	GB 4789.3
<i>Mold</i>	<i>cfu/g</i>		GB 4789.15
<i>Yeast</i>	<i>cfu/g</i>		GB 4789.15
<i>Salmonella</i>	<i>/25g</i>	<i>Absent</i>	GB 4789.4
<i>Staphylococcus aureus</i>	<i>/25g</i>		GB 4789.10
<i>Enterobacter sakazakii</i>	<i>/100g</i>		GB 4789.40
<i>Blank below</i>			

Stamp:

Issue date: ***October 1, 2014***

Note: The test results in this report are only applied to the sample received.

Examiner: ***Zhenyuan Wu***

Verify: ***Hengyuan Lv***

Zheng Yin

山东保龄宝糖类检测有限公司 检测结果报告单

NO. QR0230

编号: 201409398

实验室名称: 山东保龄宝糖类检测有限公司

实验室地址: 山东省禹城高新技术开发区东外环路1号

样品名称: 低聚异麦芽糖

规格型号: 90型

生产单位: 保龄宝生物股份有限公司 低聚糖车间

送检单位: 保龄宝生物股份有限公司

样品编号: 14092633

物态/颜色: 浅黄色、透明的粘稠液体

样品数量: 100g

检测性质: 委托检测

收样日期: 14年9月27日

始检日期: 14年9月27日

检测环境: 温度 20℃ 湿度 51%

检测项目	单位	结果	检测依据
<input type="checkbox"/> 菌落总数	cfu/g	<10	GB 4789.2
<input checked="" type="checkbox"/> 大肠菌群	MPN/g	<0.3	GB 4789.3
<input type="checkbox"/> 霉菌	cfu/g		GB 4789.15
<input type="checkbox"/> 酵母菌	cfu/g		GB 4789.15
<input checked="" type="checkbox"/> 沙门氏菌	/25g	未检出	GB 4789.4
<input type="checkbox"/> 金黄色葡萄球菌	/25g		GB 4789.10
<input type="checkbox"/> 阪崎肠杆菌	/100g		GB 4789.40
<input type="checkbox"/> 以下空白			
<input type="checkbox"/>			
<input type="checkbox"/>			
<input type="checkbox"/>			
<input type="checkbox"/>			
<input type="checkbox"/>			
<input type="checkbox"/>			
<input type="checkbox"/>			
<input type="checkbox"/>			
<input type="checkbox"/>			
<input type="checkbox"/>			



签发日期: 14年10月 | 日

备注: 本检测结果报告单只对来样负责

主检: (b) (6) [Redacted]

审核: (b) (6) [Redacted]

(b) (6) [Redacted]

Appendix D1

**Microbiological Analytical Results for BLB[®] IMO-90 Powder
(Lot No. 14071631) (Original Chinese report is attached)**

Report for Testing Results

Shandong Baolingbao Saccharides Testing Co., Ltd.

Serial No.: 201407273

NO. QR0230

Laboratory Name: Shandong Baolingbao Saccharides Testing Co., Ltd.

Laboratory Address: 1 Outer Ring East, High-Tech. Development Zone, Yucheng, Shangdong

Sample name: *Isomaltooligosaccharides*

Specification: *90-type*

Manufacturer: Baolingbao Biology Co., Ltd.
Oligosaccharide Workshop

Submitter: Baolingbao Biology Co., Ltd.

Sample No.: 14091631

State/Color: *White and amorphous powder*

Sample quantity: 100 g

Test type: *Entrusted test*

Receiving date: *July 17, 2014*

Test date: *July 17, 2014*

Test environment : Temperature: 20 °C Humidity: 51%

Test Item	Unit	Result	Test Method
<i>Aerobic plate count</i>	<i>cfu/g</i>	<i><10</i>	GB 4789.2
<i>Coliform</i>	<i>MPN/g</i>	<i><0.3</i>	GB 4789.3
<i>Mold</i>	<i>cfu/g</i>		GB 4789.15
<i>Yeast</i>	<i>cfu/g</i>		GB 4789.15
<i>Enterobacter sakazakii</i>	<i>/100g</i>		GB 4789.40
<i>Salmonella</i>	<i>/25g</i>	<i>Absent</i>	GB 4789.4
<i>Shigella</i>	<i>/25g</i>		GB 4789.5
<i>Staphylococcus aureus</i>	<i>/25g</i>		GB 4789.10
<i>Colon bacillus</i>	<i>MPN/g</i>		GB 4789.38
<i>Blank below</i>			

Stamp:

Issue date: *July 21, 2014*

Note: The test results in this report are only applied to the sample received.

Examiner: *Zhenyuan Wu*

Verify: *Hengyuan Lv*

Zheng Yin

山东保龄宝糖类检测有限公司 微生物检测结果报告单

NO.QR0230

编号: 201407273

实验室名称: 山东保龄宝糖类检测有限公司

实验室地址: 山东省禹城高新技术开发区东外环路1号

样品名称: 低聚异麦芽糖

规格型号: 90型

生产单位: 保龄宝生物股份有限公司淀粉糖厂

送检单位: 保龄宝生物股份有限公司淀粉糖厂

样品编号: 14071631

形态/颜色: 白色无定型粉末

样品数量: 100g

检测性质: 委托检测

收样日期: 14年7月17日

始检日期: 14年7月17日

检测环境: 温度 20℃ 湿度 51%

检测项目	单位	结果	检测依据
<input checked="" type="checkbox"/> 菌落总数	cfu/g	<10	GB 4789.2
<input checked="" type="checkbox"/> 大肠菌群	MPN/g	<0.3	GB 4789.3
<input type="checkbox"/> 大肠菌群	cfu/g		GB 4789.3
<input type="checkbox"/> 大肠菌群	MPN/100g		GB/T 4789.3
<input type="checkbox"/> 霉菌	cfu/g		GB 4789.15
<input type="checkbox"/> 酵母菌	cfu/g		GB 4789.15
<input type="checkbox"/> 阪崎肠杆菌	/100g		GB 4789.40
<input checked="" type="checkbox"/> 沙门氏菌	/25g	未检出	GB 4789.4
<input type="checkbox"/> 志贺氏菌	/25g		GB 4789.5
<input type="checkbox"/> 金黄色葡萄球菌	/25g		GB 4789.10
<input type="checkbox"/> 大肠埃希氏菌	MPN/g		GB 4789.38
<input type="checkbox"/> 以下空白			
<input type="checkbox"/>			
<input type="checkbox"/>			
<input type="checkbox"/>			
<input type="checkbox"/>			



签发日期: 14年7月21日

备注: 本检测结果报告单只对来样负责;

主检: (b) (6)

审核: (b) (6)

批准: (b) (6)

Appendix D2

**Microbiological Analytical Results for BLB[®] IMO-90 Powder
(Lot No. 14081032) (Original Chinese report is attached)**

Report for Testing Results

Shandong Baolingbao Saccharides Testing Co., Ltd.

Serial No.: 201408183

NO. QR0230

Laboratory Name: Shandong Baolingbao Saccharides Testing Co., Ltd.

Laboratory Address: 1 Outer Ring East, High-Tech. Development Zone, Yucheng, Shangdong

Sample name: *Isomaltooligosaccharides*

Specification: *90-type*

Manufacturer: Baolingbao Biology Co., Ltd.

Submitter: Baolingbao Biology Co., Ltd.

Oligosaccharide Workshop

Sample No.: 14081032

State/Color: *White and amorphous powder*

Sample quantity: 100 g

Test type: *Entrusted test*

Receiving date: *August 11, 2014*

Test date: *August 11, 2014*

Test environment : Temperature: 20 °C Humidity: 51%

Test Item	Unit	Result	Test Method
<i>Aerobic plate count</i>	<i>cfu/g</i>	<i><10</i>	GB 4789.2
<i>Coliform</i>	<i>MPN/g</i>	<i><0.3</i>	GB 4789.3
<i>Mold</i>	<i>cfu/g</i>		GB 4789.15
<i>Yeast</i>	<i>cfu/g</i>		GB 4789.15
<i>Enterobacter sakazakii</i>	<i>/100g</i>		GB 4789.40
<i>Salmonella</i>	<i>/25g</i>	<i>Absent</i>	GB 4789.4
<i>Shigella</i>	<i>/25g</i>		GB 4789.5
<i>Staphylococcus aureus</i>	<i>/25g</i>		GB 4789.10
<i>Colon bacillus</i>	<i>MPN/g</i>		GB 4789.38
<i>Blank below</i>			

Stamp:

Issue date: *August 15, 2014*

Note: The test results in this report are only applied to the sample received.

Examiner: *Zhenyuan Wu*

Verify: *Hengyuan Lv*

Approve: *Zheng Yin*

山东保龄宝糖类检测有限公司

微生物检测结果报告单

NO. QR0230

编号: 201408183

实验室名称: 山东保龄宝糖类检测有限公司

实验室地址: 山东省禹城高新技术开发区东外环路1号

样品名称: 低聚异麦芽糖 规格型号: 90型

生产单位: 保龄宝生物股份有限公司淀粉糖厂 送检单位: 保龄宝生物股份有限公司淀粉糖厂

样品编号: 14081032 形态/颜色: 白色无定型粉末

样品数量: 100g 检测性质: 委托检测

收样日期: 14年8月11日 始检日期: 14年8月11日

检测环境: 温度 20 °C 湿度 5 %

检测项目	单位	结果	检测依据
<input checked="" type="checkbox"/> 菌落总数	cfu/g	<u><10</u>	GB 4789.2
<input checked="" type="checkbox"/> 大肠菌群	MPN/g	<u><0.3</u>	GB 4789.3
<input type="checkbox"/> 大肠菌群	cfu/g		GB 4789.3
<input type="checkbox"/> 大肠菌群	MPN/100g		GB/T 4789.3
<input type="checkbox"/> 霉菌	cfu/g		GB 4789.15
<input type="checkbox"/> 酵母菌	cfu/g		GB 4789.15
<input type="checkbox"/> 阪崎肠杆菌	/100g		GB 4789.40
<input checked="" type="checkbox"/> 沙门氏菌	/25g	<u>未检出</u>	GB 4789.4
<input type="checkbox"/> 志贺氏菌	/25g		GB 4789.5
<input type="checkbox"/> 金黄色葡萄球菌	/25g		GB 4789.10
<input type="checkbox"/> 大肠埃希氏菌	MPN/g		GB 4789.38
<input type="checkbox"/> <u>以下空白</u>			
<input type="checkbox"/>			
<input type="checkbox"/>			
<input type="checkbox"/>			
<input type="checkbox"/>			



签发日期: 14年8月15日

备注: 本检测结果报告单只对来样负责;

主检: (b) (6) 审核: (b) (6) 批准: (b) (6)

Appendix D3

**Microbiological Analytical Results for BLB[®] IMO-90 Powder
(Lot No. 14090231) (Original Chinese report is attached)**

Report for Testing Results

Shandong Baolingbao Saccharides Testing Co., Ltd.

Serial No.: 201409038

NO. QR0230

Laboratory Name: Shandong Baolingbao Saccharides Testing Co., Ltd.

Laboratory Address: 1 Outer Ring East, High-Tech. Development Zone, Yucheng, Shangdong

Sample name: *Isomaltooligosaccharides*

Specification: *90-type*

Manufacturer: Baolingbao Biology Co., Ltd.

Submitter: Baolingbao Biology Co., Ltd.

Oligosaccharide Workshop

Sample No.: 14090231

State/Color: *White and amorphous powder*

Sample quantity: 100 g

Test type: *Entrusted test*

Receiving date: *September 3, 2014*

Test date: *September 3, 2014*

Test environment : Temperature: 20 °C Humidity: 5%

Test Item	Unit	Result	Test Method
<i>Aerobic plate count</i>	<i>cfu/g</i>	<i><10</i>	GB 4789.2
<i>Coliform</i>	<i>MPN/g</i>	<i><0.3</i>	GB 4789.3
<i>Mold</i>	<i>cfu/g</i>		GB 4789.15
<i>Yeast</i>	<i>cfu/g</i>		GB 4789.15
<i>Enterobacter sakazakii</i>	<i>/100g</i>		GB 4789.40
<i>Salmonella</i>	<i>/25g</i>	<i>Absent</i>	GB 4789.4
<i>Shigella</i>	<i>/25g</i>		GB 4789.5
<i>Staphylococcus aureus</i>	<i>/25g</i>		GB 4789.10
<i>Colon bacillus</i>	<i>MPN/g</i>		GB 4789.38
<i>Blank below</i>			

Stamp:

Issue date: *September 7, 2014*

Note: The test results in this report are only applied to the sample received.

Examiner: *Zhenyuan Wu*

Verify: *Hengyuan Lv*

Approve: *Zheng Yin*

山东保龄宝糖类检测有限公司

微生物检测结果报告单

NO.QR0230

编号: 201409038

实验室名称: 山东保龄宝糖类检测有限公司

实验室地址: 山东省禹城高新技术开发区东外环路1号

样品名称: 低聚异麦芽糖 规格型号: 90型

生产单位: 保龄宝生物股份有限公司淀粉糖厂 送检单位: 保龄宝生物股份有限公司淀粉糖厂

样品编号: 14090231 物态/颜色: 白色无定型粉末

样品数量: 100g 检测性质: 委托检测

收样日期: 14年9月3日 始检日期: 14年9月3日

检测环境: 温度 20℃ 湿度 50%

检测项目	单位	结果	检测依据
<input checked="" type="checkbox"/> 菌落总数	cfu/g	<10	GB 4789.2
<input checked="" type="checkbox"/> 大肠菌群	MPN/g	<0.3	GB 4789.3
<input type="checkbox"/> 大肠菌群	cfu/g		GB 4789.3
<input type="checkbox"/> 大肠菌群	MPN/100g		GB/T 4789.3
<input type="checkbox"/> 霉菌	cfu/g		GB 4789.15
<input type="checkbox"/> 酵母菌	cfu/g		GB 4789.15
<input type="checkbox"/> 阪崎肠杆菌	/100g		GB 4789.40
<input checked="" type="checkbox"/> 沙门氏菌	/25g	未检出	GB 4789.4
<input type="checkbox"/> 志贺氏菌	/25g		GB 4789.5
<input type="checkbox"/> 金黄色葡萄球菌	/25g		GB 4789.10
<input type="checkbox"/> 大肠埃希氏菌	MPN/g		GB 4789.38
<input type="checkbox"/> 以下空白			
<input type="checkbox"/>			
<input type="checkbox"/>			
<input type="checkbox"/>			
<input type="checkbox"/>			



盖章:
 签发日期: 14年9月7日

备注: 本检测结果报告单只对来样负责;

主检: (b) (6)

审核: (b) (6)

批准: (b) (6)

Appendix E

GB/T 8885–2008

Edible Corn Starch

ICS 67.180.20
X 11



National Standard of the People's Republic of China

GB/T 8885–2008
Replace GB/T 8885–1988

Edible Corn Starch

Issued on: August 5, 2008

Implemented on: February 1, 2009

Issued by: **General Administration of Quality Supervision, Inspection and Quarantine of the People's Republic of China; and Standardization Administration of the People's Republic of China**

Foreword

This standard replaces GB/T 8885–1988 *Edible Corn Starch*.

The major differences between this standard and GB/T 8885–1988 are as following:

- Add microbiological items according to the hygienic requirements of food safety and international common practices ;
- Add inspection rules;
- Revise organoleptic items as: appearance and odor, and withdraw mouthfeel and impurity items;
- Color and whiteness are no longer determined based on white corn and yellow corn;
- Revise moisture content to not greater than 14.0% for different grades;
- Revise acidity as: premium grade is not greater than 1.50 °T, first grade is not greater than 1.80 °T, and second grade is not greater than 2.00 °T;
- Revise ash as: second grade is not greater than 0.18%;
- Revise protein as: premium grade is not greater than 0.35%, first grade is not greater than 0.45%, and second grade is not greater than 0.60%;
- Revise spot as: first grade is not greater than 0.7/cm², and second grade is not greater than 1.0/cm²;
- Revise fineness as: premium grade is not less than 99.5%, first grade is not less than 99.0%, and second grade is not less than 98.5%;
- Revise fat as: premium grade is not greater than 0.10%, first grade is not greater than 0.15%, and second grade is not greater than 0.20%;
- Revise whiteness as: premium grade is not less than 88.0%, first grade is not less than 87.0%, and second grade is not less than 85.5%;
- Determination methods for organoleptic, protein, fat, and sulfur dioxide adopt the methods specified in GB/T 12309 *Industrial Corn Starch*;
- Test methods for acidity, arsenic and lead adopt the methods specified in GB/T 5009.53 *Analytical Methods for Starch Products*, GB/T 5009.11 *Determination of Arsenic and Inorganic Arsenic in Food* and GB/T 5009.12 *Determination for Lead in Food*, respectively;

- Mark complies with GB/T 191 *Packaging—Pictorial Marking for Handling of Goods*. Label is compliance to GB 7718 *General Standard for the Labeling of Prepackaged Foods*;
- Packaging, transportation and storage are compliance to this standard.

This standard was proposed by and is under the jurisdiction of National Technical Committee 64 on Food Industry of Standardization Administration of China.

This standard is drafted by, and in charge of the Inspection and Testing Center for Quality of Cereals and Their Products, Ministry of Agriculture of P. R. China, and with participation of the National Engineering Research Center for Corn Deep Processing.

Principal drafters for this standard: Xi Lin; Li Wu; Jingmei Li; Yi Tong; Guoxing Zhao; Xiulan Yang; and Bujun Wang.

Previously issued Edition replaced by this standard:

- GB/T 8885–1988.

Edible Corn Starch

1 Scope

This standard specifies the requirements, test methods, inspection rules, marking and labeling, packaging, transport and storage for edible corn starch.

This standard is applicable to edible starch that is produced from corn (corn must meet edible standard).

2 Normative Reference Standards

The following standards contain provisions which, through reference in this text, constitute provisions of this standard. For the dated references, subsequent amendments to (error corrections not included) or revisions of, any of these publications will be not applicable to this standard. However, the parties to agreements based on this standard are encouraged to investigate the possibility of applying the most recent editions of the standards. For undated references, the latest edition of the normative document referred to applies.

GB/T 191 Packaging—Pictorial Marking for Handling of Goods (ISO 780:1997, MOD)

GB/T 4789.3 Microbiological Examination of Food Hygiene. Examination of Coliform

GB/T 4789.15 Microbiological Examination of Food Hygiene. Examination of Mold and Yeast

GB/T 5009.11 Examinations for Total Arsenic and Inorganic Arsenic in Food

GB/T 5009.12 Examination for Lead in Food

GB/T 5009.53–2003 Analytical Methods for Starch Products of Food Hygiene

GB 7718 General Standard for the Labeling of Prepackaged Foods

GB/T 12086 Determination Method for Ash in Starch

GB/T 12087 Determination Method for Moisture in Starch Oven Method

GB/T 12095 Determination Method for Spot of Starch

GB/T 12096–1989 Determination Method for Fineness of Starch

GB/T 1209 –1989 Determination Method for Whiteness of Starch

GB/T 12309–1990 Industrial Corn Starch

3 Requirements

3.1 Organoleptic requirements

Meet requirements in Table 1.

Table 1 Organoleptic requirements

Item	Index		
	Premium Grade	First Grade	Second Grade
Appearance	White or with light yellow shadow powder, and with lustrous		
Odor	Particular scent of natural corn starch, no off-flavor		

3.2 Physicochemical requirements

Meet requirements of Table 2.

Table 2 Physicochemical requirements

Item		Index		
		Premium Grade	First Grade	Second Grade
Moisture %	\leq	14.0		
Acidity (dry basis) °T	\leq	1.50	1.80	2.00
Ash (dry basis) %	\leq	0.10	0.15	0.18
Protein (dry basis) %	\leq	0.35	0.45	0.60
Spot No./cm ²	\leq	0.4	0.7	1.0
Fat (dry basis) %	\leq	0.10	0.15	0.20
Fineness %	\geq	99.5	99.0	98.5
Whiteness %	\geq	88.0	87.0	85.0

3.3 Hygiene requirements

Meet the requirements listed in Table 3.

Table 3 Hygiene requirements

Item		Index		
		Premium Grade	First Grade	Second Grade
Sulfur dioxide (mg/kg)	\leq	30.0		

Arsenic (as As) (mg/kg) \leq	0.5
Lead (as Pb) (mg/kg) \leq	1.0
Coliform (MPN/100 g) \leq	70
Mold (CFU/g) \leq	100

4 Test Methods

4.1 Organoleptic

Implement according to GB/T 12309 – 1990, Sec. 4.2.

4.2 Moisture

Implement according to GB/T 12087.

4.3 Acidity

Implement according to GB/T 5009.53, Sec. 4.6. Conduct blank test at same time.

4.4 Ash

Implement according to GB/T 12086.

4.5 Protein

Implement according to GB/T 12309 – 1990, Sec. 4.3.6.

4.6 Spot

Implement according to GB/T 12095.

4.7 Fat

Implement according to GB/T 12309 – 1990, Sec. 4.3.7.

4.8 Fineness

Implement according to GB/T 12096 – 1989. In Sec. 4.2, follow the requirements in below: use 0.15 mm of testing sieve.

4.9 Whiteness

Implement according to GB/T 12097 – 1989. In Sec. 4.1, follow the requirements in below: use whiteness meter: wave length 420 nm – 470 nm, and use suitable sample box and standard white board, with precision to 0.1.

4.10 Sulfur dioxide

Implement according to GB/T 12309 – 1990, Sec. 4.3.8.

4.11 Arsenic

Implement according to GB/T 5009.11.

4.12 Lead

Implement according to GB/T 5009.12.

4.13 Coliform

Implement according to GB/T 4789.3.

4.14 Mold

Implement according to GB/T 4789.15.

5 Inspection Rules

5.1 Batch and sampling

5.1.1 Batch

The batch is defined as the packaged product with same specification, which is produced in same production line with same raw materials and production date.

5.1.2 Sampling

Every sampling plan is calculated in accordance with formula (1):

$$n = \sqrt{N/2} \dots\dots\dots (1)$$

Where:

n – Number of sampling packages, unit is bag;

N – Number of total packages of a batch, unit is bag.

5.2 Delivery test

Delivery tests include organoleptic and physicochemical items. The product is delivered after it qualifies all tested requirements.

5.3 Type test

5.3.1 Type test includes all items in technical requirements.

5.3.2 In normal condition, product is tested semiannually; it must be tested at any time in the following cases, when:

- a) New product is finalized in design and in evaluation;
- b) Major processing technique and production equipment are changed;
- c) Production of down time is exceeded for half year, and then production is restarted;
- d) Delivery test results have significant differences compared with ones of the last type tests;
- e) National quality supervision agency or the management requires conducting type tests.

5.4 Decision rules

5.4.1 One of the hygiene items is not qualified, the entire batch of product is considered as unqualified.

5.4.2 Re-inspection: for unqualified mark, labeling and packaging, the product is allowed to rectify and improve, and then apply for re-inspecting for one more time. Re-inspection results are final results. If one of organoleptic and physicochemical items is unqualified, double sampling amount and conduct re-inspections, and re-inspection results are final results.

6 Label, Mark, Packaging, Transportation and Storage

6.1 Label and mark

Implement according to GB 7718. Mark must meet the requirements of GB/T 191.

6.2 Packaging

Packaging materials must be dry, clean, firm, and meet the hygiene requirements of packaging materials.

6.3 Transportation

Transportation equipment must be clean and hygienic, and no strong pungent; the product cannot be mixed packaged and transported with toxic, hazardous, and caustic goods. Keep the product dry and clean during transportation.

6.4 Storage

6.4.1 The product is stored in cool, dry, circulated and free from contamination place, and is not piled up in open place.

6.4.2 The shelf-life of the product is 18 months.

Appendix F

GB 8275–2009

Food Additive – alpha-Amylase Preparation

ICS 67.220.20
X 41



National Standard of the People's Republic of China

GB 8275–2009
Replace GB 8275–1987

Food Additive—Alpha-amylase Preparation

Issued on: January 19, 2009

Implemented on: August 1, 2009

Issued by: **General Administration of Quality Supervision, Inspection and Quarantine of the People's Republic of China; and Standardization Administration of the People's Republic of China**

Foreword

In this standard, Sec. 5.2 and 5.3 are mandatory, the rest of them are recommendatory.

In this standard, the hygiene requirements for products in Class A consult “Hygiene Index” in *General Rules for Food Industry Enzyme Preparations* in Compendium of Food Additive Specifications, Volume 1, Joint FAO/WHO Expert Committee of Food Additive (JECFA) and “additional requirements” for enzyme preparation in US Food Chemicals Codes, FCC V.

This standard replaces GB 8275–1987 *Food Additive α -Amylase Preparation*.

The major differences between this standard and GB 8275–1987 are as following:

- Add liquid product type and heat tolerance product type, and set the corresponding indexes;
- Withdraw the items of fineness, enzyme activity retention, heavy metal, and aflatoxins B₁;
- Add items of total bacteria count, and lactic acid bacillus.

Appendix A in this standard is normative appendix; Appendix B and C are reference appendices.

This standard was proposed by National Food Additive Standardization Administration of China.

This standard is under the jurisdiction of National Food Additive Standardization Administration of China.

The drafting organizations for this standard: China National Research Institute of Food and Fermentation Industries; Shandong Longda Bio-products Co., Ltd.; Wuxi Syder Bio-products Co., Ltd.; Novozymes (China) Biotechnology Co., Ltd.; Xingtai Xinxin Xiangyu Biology Engineering Co., Ltd.; Jiangyin BSD Bio-engineering Co., Ltd.; Danisco (China) Co., Ltd.

Principal drafters for this standard: Wei Zhang; Qingwen Guo; Bingyan Wu; Wenjing Qu; Jianlong Gu; Miao Wen; Xinguang Guo; Xijiang Yang; Hongqing Hu, Yilong Kang; Kun Wei; Zhichong Lu; Deqiang Li.

The previous issued Edition replaced by this standard:

- GB 8275–1987.

Food Additive α -Amylase Preparation

1 Scope

This standard specifies the terms and definitions, classification of products, requirements, test methods, inspection rules, marking and labeling, packaging, transportation, storage and shelf-life for α -amylase preparation.

This standard is applicable to the α -amylase preparation that produced through fermentation with starch (or sugar) materials and purification. The microbial strains are approved by GB 2760–2007, Table C.2.

2 Normative Reference Standards

The following standards contain provisions which, through reference in this text, constitute provisions of this standard. For the dated references, subsequent amendments to (error corrections not included) or revisions of, any of these publications will be not applicable to this standard. However, the parties to agreements based on this standard are encouraged to investigate the possibility of applying the most recent editions of the standards. For undated references, the latest edition of the normative document referred to applies.

GB 2760–2007 Hygienic Standard for Uses of Food Additives

GB/T 4789.2 Microbiological Examination of Food Hygiene. Examination of Aerobic Plate Count

GB/T 4789.3 Microbiological Examination of Food Hygiene. Examination of Coliform

GB/T 4789.4 Microbiological Examination of Food Hygiene. Examination of Salmonella

GB/T 4789.6 Microbiological Examination of Food Hygiene. Examination of Lactic Acid Bacteria

GB/T 5009.11 Examinations for Total Arsenic and Inorganic Arsenic in Food

GB/T 5009.12 Examination for Lead in Food

GB/T 6682 Water for Analytical Laboratory Use – Specification and Test Methods (ISO 3696:1987, MOD)

QB/T 1803–1993 General Test Methods for Industrial Enzyme Preparations

3 Terms and Definitions

The following terms and definitions are applicable to this standard.

3.1 α -amylase

Hydrolyze α -1,4 glycosidic bond presented in starch molecule into short chain dextrin, small amount of maltose and glucose, so that the viscosity of starch decreases rapidly.

3.2 Activity of medium temperature alpha-amylase

1 g of solid enzyme powder (or 1 ml of liquid enzyme) liquefies 1 g of soluble starch for 1h at the condition of 60 °C and pH 6.0. That is 1 unit of enzyme activity, and expressed as u/g (u/ml).

3.3 Activity of heat-tolerant alpha-amylase

1 g of solid enzyme powder (or 1 ml of liquid enzyme) liquefies 1 mg of soluble starch for 1min at the condition of 70 °C and pH 6.0. That is 1 unit of enzyme activity, and expressed as u/g (u/ml).

4 Classification of Products

4.1 Based on the suitable temperature, the products are classified as: medium temperature alpha-amylase preparation and heat-tolerant alpha-amylase preparation.

4.2 Based on the product form, the products are classified as: liquid form of enzyme preparation and solid form of enzyme preparation,

5 Requirements

5.1 Appearance

Solid form: White to tan color of solid powder. No moldy, deliquescence, agglomeration, no off-flavor, and water soluble.

Liquid form: Tan to dark brown color of liquid. No off-flavor, allowable small amount of condensed matter.

5.2 Physicochemical requirements

Meet requirements of Table 1.

Table 1 Physicochemical Requirement for α -Amylase Preparation

Item	Liquid Form		Solid Form	
	Medium tem. α -amylase preparation	Heat-tolerant α -amylase preparation	Medium tem. α -amylase preparation	Heat-tolerant α -amylase preparation
Enzyme activity ^a , u/ml or u/g \geq	2,000	20,000	2,000	20,000

pH (25 °C)	5.5-7.0	5.8-6.8	—	
Volume weight, g/ml	1.10-1.25	1.10-1.25	—	
Drying loss, % ≤	—		8.0	
Livability of heat-tolerance, % ≥	—	90	—	90
^a The specification can also be implemented based on contract between supplier and customer				

5.3 Hygiene requirements

Meet the requirements listed in Table 2.

Table 2 Hygiene Requirements for α -Amylase Preparation

Item	Index
Lead (mg/kg) ≤	5
Arsenic (mg/kg) ≤	3
Total count of bacteria (CFU/g) ≤	5×10^4
Coliform (MPN/100 g) ≤	3×10^3
Salmonella (25 g sample)	Absent
Lapactic colon bacteria	Absent
Note: For enzyme used in distilled spirit products, not required to implement Table 2.	

6 Test Methods

Unless otherwise noted, water used in this standard meets the requirements of GB/T 6682.

All reagents used in this standard are analytical purity, unless otherwise noted. They should be clearly specified if there are special requirements.

All solutions used in this standard are aqueous solutions, unless otherwise noted.

6.1 Appearance

Weigh 10 g (ml) of sample, and observe and sniff the sample to make judgment.

6.2 Activity of enzyme

6.2.1 Principle

α -Amylase preparation can randomly cut off α -1,4 glycoside bond in starch molecule to form short chain of dextrin, small amount of maltose and glucose, so that the characteristic of blue

color presented in the reaction between starch and iodine is gradually vanished, and red brown color is shown. The rate of color vanishing is related to the enzyme activity. Therefore, activity of enzyme can be calculated by measuring absorbency after the reaction.

6.2.2 Reagents and solutions

6.2.2.1 Iodine;

6.2.2.2 Potassium iodide;

6.2.2.3 Original iodine solution: Weigh 11.0 g iodine and 22.0 g potassium iodide, dissolve in small amount of water, and dilute to 500 ml. Store in brown bottle.

6.2.2.4 Dilute iodine solution: Measure 2.00 ml of original iodine solution and add 20.0 g potassium iodide, then dissolve in water, and dilute to 500 ml. Store in brown bottle.

6.2.2.5 Soluble starch solution (20 g/l): Weigh 2.000 g (precision to 0.001 g) soluble starch (as absolute dry) and put into a beaker, then add small amount of water to mix paste. Slowly add 70 ml of boiling water while stirring. Rinse the beaker several times by water, and add the washing water in the volumetric flask, and then heat and stir until completely transparent. Cool down and dilute to 100 ml. This solution is prepared just before use.

Note: Soluble starch should use the special soluble starch for enzyme produced by Huzhou Zhanwang Chemical & Pharmaceutical Co., Ltd.

6.2.2.6 Phosphoric acid buffer solution (pH = 6.0): Weigh 45.23 g of disodium hydrogen phosphate ($\text{Na}_2\text{HPO}_4 \cdot 12\text{H}_2\text{O}$) and 8.07 g of citric acid ($\text{C}_6\text{H}_8\text{O}_7 \cdot \text{H}_2\text{O}$), and dissolve with water and then dilute to 1000 ml. Calibrated with pH meter before use.

6.2.2.7 Hydrochloric acid solution [$c(\text{HCl}) = 0.1 \text{ mol/l}$]: Prepared according to GB/T 601.

6.2.3 Apparatus

6.2.3.1 Spectrophotometer;

6.2.3.2 Constant temperature water bath: temperature control precision to $\pm 0.1 \text{ }^\circ\text{C}$;

6.2.3.3 Automatic pipettor;

6.2.3.4 Test tube: 25 mm X 200 mm;

6.2.3.5 Stopwatch.

6.2.4 Analysis procedure

6.2.4.1 Preparation of the test enzyme solution

Weigh 1–2 g of enzyme powder (precision to 0.0001 g) or accurately measure 1.00 ml of liquid enzyme solution, and thoroughly dissolve with small amount of phosphoric acid buffer solution (6.2.2.6). Carefully pour the supernatant fluid into a volumetric flask. If there is residue, grind it thoroughly with small amount of phosphoric acid buffer solution, and then transfer all of sample into the volumetric flask, and dilute to the mark with phosphoric acid buffer solution. Shake well. The solution is filtrated by 4 layers of gauze; the filtrate is ready for future use.

Note: For the activity of medium temperature enzyme, the concentration is controlled within range of 3.4 – 4.5 u/ml. For the activity of heat-tolerant enzyme, the concentration is controlled within range of 60 – 65 u/ml.

6.2.4.2 Measurement

— Transfer 20.0 ml of soluble starch solution (6.2.2.5) into a test tube, then add phosphoric acid buffer solution (6.2.2.6). Shake well. Put it on constant temperature water bath at 60 ± 0.2 °C (at 70 ± 0.2 °C for heat-tolerant enzyme preparation) for 8 min;

— Add 1.00 ml of diluted test enzyme solution (6.2.4.1), record time immediately, shake well and accurately reacts for 5 min.

— Immediately transfer 1.00 ml of reaction solution by automatic pipettor into the test tube in which 0.5 ml of hydrochloric acid solution (6.2.2.7) and 5.00 ml of dilute iodine solution (6.2.2.4) were previously filled. Shake well. Measure absorbency (A) of the above solution rapidly using 10 mm cuvette at 660 nm of wave length. Use 0.5 ml of hydrochloric acid solution and 5.00 ml of dilute iodine solution as blank. Calculate the concentration of test enzyme solution from Table A.1 using the absorbency.

6.2.4.3 Calculation

6.2.4.3.1 Activity of medium temperature enzyme is calculated based on formula (1):

$$X_1 = c \times n \quad \dots\dots\dots (1)$$

Where:

X_1 – Activity of enzyme of the sample, u/ml or u/g;

c – Concentration of test enzyme solution, u/ml or u/g;

n – Multiple of dilution.

The result is expressed to integer.

6.2.4.3.2 Activity of heat-tolerant enzyme is calculated based on formula (2):

$$X_2 = c \times n \times 16.67 \dots\dots\dots (2)$$

Where:

X_2 – Activity of enzyme of the sample, u/ml or u/g;

c – Concentration of test enzyme solution, u/ml or u/g;

n – Multiple of dilution;

16.67 – Coefficient calculated based on activity of enzyme.

The result is expressed to integer.

6.2.5 Allowable Deviation

The relative difference of results between two parallel tests is not greater than 5%.

6.3 pH

Implement according to the Chapter 9 of QB/T 1803–1993.

6.4 Survival rate of heat-tolerant α -amylase preparation.

6.4.1 Reagents and solutions

6.4.1.1 Sodium hydroxide solution [c (NaOH) = 0.1 ml/l]

Prepared according to GB/T 601.

6.4.1.2 Dextrin solution

Weigh 100.0 g of dextrin and put into a beaker, and add 300 ml of water and then mix well. Add heat-tolerant α -amylase preparation (adding amount is based on 13 u of activity of enzyme/g dextrin) into it, then put it on electric oven to heat to boiling, and cool down. Adjust pH of the solution to 6.0–7.0 with sodium hydroxide solution (6.4.1.1), and transfer to 500 ml of volumetric flask, and dilute to the mark. Shake well for future use.

6.4.2 Apparatus

Constant temperature water bath: Precision of temperature control: ± 0.1 °C.

6.4.3 Analysis procedure

6.4.3.1 Preparation of the test enzyme solution

Except using dextrin solution (6.4.1.2) replaces phosphoric acid buffer solution (6.2.2.6), the rest of procedures follow 6.2.4.1.

6.4.3.2 Heat treatment

Measure 25 ml of test enzyme solution and put into 50 ml of cuvette, and put on constant temperature water bath at 95 °C for 60 min. Cool down and add water to the original volume of the test enzyme solution. Shake well for future use.

6.4.3.3 Measurement of activity of enzyme

- a) Measure activity of enzyme for the enzyme prepared in 6.4.3.1 according to 6.2.4.2.
- b) Measure activity of enzyme for the enzyme solution after heat treated (6.4.3.2) according to 6.2.4.2.

6.4.4 Calculation

Survival rate of heat-tolerant enzyme is calculated as formula (3):

$$X_3 = E_1/E \times 100 \quad \dots\dots\dots (3)$$

Where:

X_3 – Survival rate of heat-tolerant sample enzyme, %;

E_1 – Activity of enzyme actually measured after heat treated, u/ml or u/g;

E – Activity of enzyme actually measured before heat treated, u/ml or u/g.

The result is expressed to integer.

6.5 Volume weight

Test according to the Chapter 8 of QB/T 1803–1993.

6.6 Drying loss

Test according to the Chapter 6 of QB/T 1803–1993.

6.7 Lead

Test according to GB/T 5009.12.

6.8 Arsenic

Test according to GB/T 5009.11.

6.9 Total count of bacteria

Test according to GB/T 4789.2.

6.10 Coliform

Test according to GB/T 4789.3.

6.11 Salmonella

Test according to GB/T 4789.4.

6.12 Lactic acid bacteria

Test according to GB/T 4789.6.

7 Inspection Rules

7.1 Determination of batch

The batch number is determined by manufacturer according to the corresponding rules. The quality of product in same batch must be uniform.

7.2 Sampling rules and sample number

Sampling must be distributed uniformly in the entire filling process, or distributed uniformly in the finished product after filling process.

Sampling must use suitable method to ensure the samples have representative, to ensure cleanness of the sampling spot and sampling bottle. For sample that is used for microbiological test, aseptic sampling must be use.

Sampling size for finished product is specified in Table 3. Sampling size is determined according to estimated batch size and is referred to Table 3, or determined by manufacturer and/or according to related method. Batch size is the numbers of product in the batch, and its unit is barrel or carton. Sampling size is the numbers of unit of the sample, and its unit is barrel or bag. Batch sampling amount is not less 300 ml (or 300 g). If sampling amount is not enough, it must be scale-up.

Table 3 Sample Size for Sampling of Finished Product

Batch Size, Barrel (or Carton)	Sampling Size, Barrel (or carton)
< 50	2
51–500	3
> 500	4

7.3 Delivery inspection

When a batch of product is delivered, tests must be conducted for appearance, activity of enzyme, pH, volume weight, drying loss (solid), total count of bacteria, as well as packaging and label, etc.

7.4 Type tests

If in one of the following cases, all items must be tested according to this standard:

- In normal production, products are tested at least once a year;
- In normal production, if raw materials or processing technique are changed significantly, and the quality of products may be affected;
- After equipment is changed, or production has a long period of down time, the production is restarted;
- When significant differences are found between results of delivery tests and normal production;
- Requested by national supervision and inspection agency.

7.5 Judgment rules

When the results of delivery test and /or results of type tests are qualified, the department of quality inspection should provide certificate for the product.

When the results of delivery test and /or results of type tests are not qualified, double amount of sample is taken and analyzed in the basis of the original batch. If still not qualified, the product is judged as unqualified, and cannot be delivered.

8 Label, mark, packaging, transportation and storage

8.1 Label and mark

Food additive must have packaging labeling and statement of the product. Labeling contents include: product name, manufacturing address, manufacturer name, hygienic permit No., production permit No., specification, production date, batch No. or code No., shelf-life, etc, and clearly mark “food additive” typeface on the label.

8.2 Packaging

Packaging materials must meet corresponding hygienic standards for related food packaging materials that are state approval.

8.3 Transportation

Products should be handled carefully, and prevent from rain and strong sunlight. Transportation equipment must be clean, nontoxic, and free from contamination. Product cannot be mixed packed and transported with toxic, hazardous, and caustic goods.

8.4 Storage

Store the product in cool and dry place, and prevent mixed storage from toxic, hazardous and caustic goods.

8.5 Shelf-life

8.5.1 In condition of below 25 °C, the shelf-life for liquid enzyme preparation is not less than 90 days. For solid enzyme preparation, its shelf-life is not less than 180 days. Manufacturer should make detail marking according to above requirements.

8.5.2 The actual enzyme activity must not be lower than the one marked on label during whole shelf-lie.

Appendix G

QB 2526–2001

Food Additive – Fungi alpha–Amylase

Classification No.: X 41

Record No.: 9490-2001



Light Industry Standard of the People's Republic of China

QB 2526-2001

Food Additive Fungus α -Amylase

Issued on: November 15, 2001

Implemented on: May 1, 2002

Issued by: **China National Light Industry Council**

Foreword

All technical contents in this standard are mandatory.

Food additive of α -amylase is produced by processes of fermentation of *Aspergillus oryzae*, and purification. The enzyme is used as processing aid in productions in food industry.

This standard was proposed by the Comprehensive Business Department, China National Light Industry Council.

This standard is under the jurisdiction of China National Standardization Center of Food and Fermentation.

This standard is drafted by, and in charge of China Food and Fermentation Industry Institute; and Beijing Cathay Industrial Biotech Ltd.

Principal drafters for this standard: Qixian Zhang; Yuhong Wy; Lianfang Liu.

Light Industry Standard of the People's Republic of China

QB 2526–2001

Food Additive Fungus α -Amylase

1 Scope

This standard specifies the technical requirements, test methods, inspection rules, as well as labeling, packaging, transportation, and storage for food additive of α -amylase.

This standard is applicable to the α -amylase that is produced by fermentation of *Aspergillus oryzae*, and purification. The enzyme is used as processing aid in food production.

2 Normative Reference Standards

The following standards contain provisions which, through reference in this text, constitute provisions of this standard. When this standard is published, all editions are valid; however, all standards will be revised. The parties to agreements based on this standard are encouraged to investigate the possibility of applying the most recent editions of the standards.

GB/T 8449–1987 Determination of Lead in Food Additives

GB/T 8450–1987 Determination of Arsenic in Food Additives

GB/T 8451–1987 Determination of Heavy Metal Limitation in Food Additives

GB 4789.2–1994 Microbiological Examination of Food Hygiene. Examination of Total Count of Bacteria

GB 4789.3–1994 Microbiological Examination of Food Hygiene. Examination of Coliform

GB 4789.4–1994 Microbiological Examination of Food Hygiene. Examination of Salmonella

GB 4789.6–1994 Microbiological Examination of Food Hygiene. Examination of Lactic Acid Bacteria

QB/T 1803–1993 General Test Methods Used for Industrial Enzyme Preparations

3 Technical Requirement

3.1 Characteristics

The product is brown liquid.

3.2 Physicochemical index

Physicochemical index must meet requirements of Table 1.

Table 1

Item	Index
Activity of α -amylase, u/ml \geq	20,000
pH	6.0–7.0
Arsenic (As), mg/kg \leq	2
Lead (Pb), mg/kg \leq	5
Heavy metal (Pb), mg/kg \leq	30

3.3 Microbiological index

Microbiological index must meet the requirements of Table 2.

Table 2

Item	Index
Total count of bacteria, CFU/ml \leq	5×10^4
Coliform, MPN/100 ml \leq	3,000
<i>Salmonella</i> \leq	Absent
<i>E. Coli.</i>	Absent

4 Test Method

Unless otherwise noted, all reagents used in this standard are analytical purity, and water is distilled water or equivalent purity of water.

4.1 Determination of activity of α -amylases

4.1.1 Principle

The enzyme reacts with starch solution to produce reducing sugar. When add Fehling's solution, and in heating condition, the cuprous oxide precipitate is formed quantitatively. After add potassium iodide and sulfuric acid, the free iodine is then formed, which is immediately titrated using sodium thiosulfate solution.

4.1.2 Reagents and solutions

- a) 30% of potassium iodide solution: 150 g of potassium iodide is dissolved in 350 ml of water, and preserved in brown bottle. Avoid direct sunlight;
- b) 25% of sulfuric acid solution: 125 g of sulfuric acid is dissolved in 375 ml of water;
- c) 0.05 mol/l of sodium thiosulfate solution: 500 ml of 0.1 mol/l sodium thiosulfate stock that is used for quantitative analysis is diluted to 1000 ml with cold water that was previously boiled. Then, calibrate the solution and obtain the concentration correction factor f ;
- d) 1 mol/l of acetic acid–sodium acetate buffer solution (pH 5.0): 1 mol/l sodium acetate solution is added in 1 mol/l acetic acid solution, and pH value is adjusted to 5.0;
- e) Soluble starch solution (pH 5.0): After soluble starch (reagent grade) is dried at 105 °C for 4 h, it is weighed and moisture content is calculated. Then, according to the moisture content, 0.5 g of soluble starch (dry basis) is weighed, and slowly added in 50 ml of boiling water, boiled for 5 min, then cool down by water. Add 5 ml of 1 mol/l acetic acid-sodium acetate buffer solution (pH 5.0), and dilute to 100 ml;
- f) Fehling's solution:
 - Copper solution: 34.66 g of copper sulfate is dissolved in water and diluted to 500 ml;
 - Potassium sodium tartrate solution: 173 g of potassium sodium tartrate and 50 g of sodium hydroxide are dissolved in water and diluted to 500 ml;
 - Accurately take same volume of the copper solution and the alkaline, and thoroughly mix before use.

4.1.3 Test method

4.1.3.1 Preparation of the sample solution

Dilute the enzyme sample with water, and control the value of $(T_0 - T_{30}) \times f \times 1.26$ of the enzyme solution in the range of 3–6 mg of glucose.

Example: Fungus α -amylase: [$n=50,000$] dilute 1 ml \longrightarrow 2500 ml, and then dilute 1 ml \longrightarrow 200 ml.

4.1.3.2 Measurement

Add 10 ml of soluble starch solution (4.1.2. e) into a 100 ml of Erlenmyer triangular flask, and put in constant temperature water bath at $(40 \pm 0.5)^\circ\text{C}$ for 10 – 15 min, and then add 1 ml of the sample dilute solution (4.1.3.1). After accurately heat for 30 min, add 4 ml of Fehling's solution (4.1.2. f) to inactivate the enzyme. Heat the triangular flask using gas burner (or electric stove) for 2 min, then immediately put in cold water for cooling. Add 2 ml of 30% potassium iodide solution (4.1.2. a) and 2 ml of 25% sulfuric acid solution (4.1.2. b), and then titrate the free iodine using 0.05 mol/l of sodium thiosulfate solution (4.1.2. c) to the end point T_{30} (ml), where blue color is vanished.

Blank test: The enzyme solution is replaced by water, and put into another triangular flask. Measure the blank value T_0 (ml) according to the above operation procedure. When the titration is closed to end point, add 1-2 drops of 1% soluble starch solution [using soluble starch (reagent grade, prepared separately), until reach end point where blue color is vanished.

4.1.4 Expression of analytical result

React for 30 min under the above conditions, the enzyme amount used to produce 10 mg of glucose in the reaction solution is defined as one unit of activity of amylase.

4.1.4.1 Calculate the activity of the enzyme in accordance with formula (1):

$$\text{Activity of amylase (U/ml)} = (T_0 - T_{30}) \times f \times 1.62 \times \frac{1}{10} \times n \quad \dots\dots\dots (1)$$

Where:

T_{30} – Volume of sodium thiosulfate standard solution consumed during the titration of enzyme reaction solution, ml;

T_0 – Volume of sodium thiosulfate standard solution consumed during the titration of blank solution, ml;

f – The correction factor of concentration of 0.05 mol/l of sodium thiosulfate solution;

1.62 – Coefficient;

1/10 – Constant number of this test method (reducing sugar that is equivalent to 10 mg glucose);

n – Dilution multiple of enzyme sample.

4.1.5 Allowable deviation

The relative deviation is not greater than 5% in duplicate tests.

4.2 Determination of pH

Test according to the pH test method in QB/T 1803–1993.

4.3 Determination of arsenic

Test according to GB/T 8450.

4.4 Determination of lead

Test according to GB/T 8449.

4.5 Determination of heavy metal

Test according to GB/T 8451.

4.6 Determination of total count of bacteria

Test according to GB 4789.2.

4.7 Determination of *Coliform*

Test according to GB 4789.3.

4.8 Determination of *Salmonella*

Test according to GB 4789.4.

4.9. Determination of *Escherichia*

Test according to GB 4789.6.

5 Inspection Rules

5.1 Product must be tested by department of quality inspection and passed. Only the product attached with certificate can enter warehouse or delivery.

5.2 The batch is the product that is produced in same tank, and is packaged for delivery, by using the same processing technique, same product name, same batch No., same specification and same certificate of quality.

5.3 Sampling method

2 different types of sampling methods are used for physicochemical test and microbiological test of finished product, respectively.

5.3.1 Sampling for physicochemical analysis of finished product

Take sample from fermentation tank. Start agitator in the tank before sampling, stir the liquid enzyme for at least 12 h, clean the sampling valve using worm water, then wash the valve using 100 ml of enzyme liquid discharged from the tank. Discharge 80 ml of the enzyme liquid from the tank into glass bottle, and put it into refrigerator for physicochemical test.

5.3.2 Sampling for microbiological analysis of finished product

Take sample from fermentation tank. Start agitator in the tank before sampling, stir the liquid enzyme for at least 4 h, clean the sampling valve using worm water, then wash the valve using iodine solution, then discharge 100 ml of enzyme liquid from the tank to wash off the iodine solution residue in the valve. Discharge 80 ml of the enzyme liquid from the tank into septic glass bottle, and put it into refrigerator for microbiological test.

5.4 Activity of amylase, pH, and microbiological index are mandatory testing items. Arsenic, lead and heavy metal are type test items, and need to be tested once of half year. If one of the items in the testing items is not passed the requirement of this standard, the sampling amount should be doubled, and then the unqualified item is retested. If still not passed, the entire batch of product is judged as not passing the requirements of this standard.

5.5 When dissent regarding the quality of product existed between the parties of supplier and customer, and need to arbitrate, so the arbitration agency should be chosen by both parties who have reach consensus. During arbitration, arbitration analysis must be conducted according to the test methods specified in this standard.

6 Labeling, packaging, transportation and storage

6.1 Labeling

Label must firmly stick on the package of product. Labeling contents include: manufacturer name, manufacturing address, product name, trade mark, product specification, batch No., production date, shelf-life, main parameters of product, net content, and product standard No., and mark of “food additive” typeface on the label. Certificate of product is attached to the product.

6.2 Packaging

6.2.1 Inner package is 20 L of polyethylene barrel.

6.2.2 Outer package is paper carton or steel barrel with coating inside.

6.3 Transportation

Products should be handled carefully, cannot be mixed with other packages and cannot be transported with toxic, hazardous, and caustic goods. Prevent from rain and strong sunlight.

6.4 Storage

The product is stored in cool and dry indoor place at 15–25 °C, and prevent from mixed storage with toxic, hazardous, perishable and contaminative goods.

6.5 Shelf-life

The shelf-life of the product is 3 months when product is compliance to the conditions of storage with package intact, and package is unopened. When exceeding shelf-life, the activity of enzyme is possible decreased, but it still can be used with increased the amount of use.

Appendix H

GB 25594–2010

Enzyme Preparations Used in Food Industry



National Standard of the People's Republic of China

GB 25594–2010

National Standard for Food Safety Enzyme Preparations Used in Food Industry

Issued on: December 21, 2010

Implemented on: February 21, 2011

Issued by:

Ministry of Health of the People's Republic of China

National Standard for Food Safety

Enzyme Preparations Used in Food Industry

1 Scope

This standard is applicable to the enzyme preparations used in food industry specified in GB 2760.

2 Normative Reference Standards

The references cited in this standard are requisite for the use of this standard. For the dated references, only the dated editions are applicable to this standard. For undated references, the latest edition of the normative document (including all amendments) referred to applies.

3 Term and Definition

3.1 Enzyme preparation

Directly extract from edible parts or non-edible parts of animals or plants, or through fermentation by conventional or by genetically modified microorganisms (include but not limited to strains of bacteria, ray fungi, and fungi), and then following extract and refine processes. Enzyme preparation is bio-product that is used in food processing and has special catalysis.

3.2 Activity of antibiosis

The capability of inhibiting or sterilizing microbial.

4 Technical Requirement

4.1 Requirements for raw materials

4.1.1 The raw materials used for production of enzyme preparation must comply to the Good Manufacturing Practice or comply to other related requirements. In normal conditions, enzyme preparations should not present harmful residual contaminations for the finished products.

4.1.2 For enzyme preparation originated from animals, the animal tissues must meet requirements of meat quarantine.

4.1.3 For enzyme preparation originated from plants, the plant must not go moldy.

4.1.4 The classification and/or genetics for microorganism strain must be identified and meet the related requirements. Strain preservation method and condition must ensure the stability and repeatability between fermenting batches.

4.2 Contamination limit: Must meet the requirements in Table 1.

Table 1 Physicochemical Index

Item	Index	Test Method
Lead (Pb), mg/kg	≤ 5	GB 5009.12
Inorganic arsenic, mg/kg	≤ 3	GB/T 5009.11

4.3 Microbiological index: Must meet the requirements in Table 2. The production strain must be absent in the enzyme preparation that is produced by microorganism with gene recombination technology.

Table 2 Microorganism Index

Item	Index	Test Method
Total count of bacteria, CFU/g or CFU/ml	≤ 50,000	GB 4789.2
Coliform, CFU/g or CFU/ml	≤ 30	GB 4789.3 plate count
E. Coli, 25 g or 25 ml	Absent	GB/T 4789.38
Salmonella, 25 g or 25 ml	Absent	GB 4789.4

4.4 Activity of antibiosis

The activity of antibiosis must not present in the enzyme preparations originated from microorganisms.

Appendix I

QB 2525–2001

Food Additive – alpha–Glucosidase

Classification No.: X 41
Record No.: 9489-2001



Light Industry Standard of the People's Republic of China

QB 2525-2001

Food Additive
 α -Glucosidase

Issued on: November 15, 2001

Implemented on: May 1, 2002

Issued by: China National Light Industry Council

Foreword

All technical contents in this standard are mandatory.

Food additive of α -glucosidase is produced by processes of fermentation of *Aspergillus niger*, heat treatment, filtration, concentration and purification. The enzyme is used as processing aid in productions in food industry.

This standard was proposed by the Comprehensive Business Department, China National Light Industry Council.

This standard is under the jurisdiction of China National Standardization Center of Food and Fermentation.

This standard is drafted by, and in charge of China Food and Fermentation Industry Institute; and Beijing Cathay Industrial Biotech Ltd.

Principal drafters for this standard: Qixian Zhang; Yuhong Wy; Lianfang Liu.

Light Industry Standard of the People's Republic of China

QB 2525–2001

Food Additive

α -Glucosidase

1 Scope

This standard specifies the technical requirements, test methods, inspection rules, as well as labeling, packaging, transportation, and storage for food additive of α -glucosidase.

This standard is applicable to the α -glucosidase that is produced by fermentation of *Aspergillus niger*, heat treatment, filtration, concentration and purification. The enzyme is used as processing aid in food production.

2 Normative Reference Standards

The following standards contain provisions which, through reference in this text, constitute provisions of this standard. When this standard is published, all editions are valid; however, all standards will be revised. The parties to agreements based on this standard are encouraged to investigate the possibility of applying the most recent editions of the standards.

GB/T 8449–1987 Determination of Lead in Food Additives

GB/T 8450–1987 Determination of Arsenic in Food Additives

GB/T 8451–1987 Determination of Heavy Metal Limitation in Food Additives

GB 4789.2–1994 Microbiological Examination of Food Hygiene. Examination of Total Count of Bacteria

GB 4789.3–1994 Microbiological Examination of Food Hygiene. Examination of Coliform

GB 4789.4–1994 Microbiological Examination of Food Hygiene. Examination of Salmonella

GB 4789.6–1994 Microbiological Examination of Food Hygiene. Examination of Lactic Acid Bacteria

QB/T 1803–1993 General Test Methods Used for Industrial Enzyme Preparations

3 Technical Requirement

3.1 Characteristics

The product is brown liquid.

3.2 Physicochemical index

Physicochemical index must meet requirements of Table 1.

Table 1

Item		Index
Activity of α -glucosidase, u/ml	\geq	300,000
Activity of amylase, u/ml	\leq	300
pH (25 °C)		4.50–5.5.0
Arsenic (As), mg/kg	\leq	3
Lead (Pb), mg/kg	\leq	5
Heavy metal (Pb), mg/kg	\leq	30

3.3 Microbiological index

Microbiological index must meet the requirements of Table 2.

Table 2

Item		Index
Total count of bacteria, CFU/ml	\leq	1×10^4
Coliform, MPN/100 ml	\leq	3,000
<i>Salmonella</i>		Absent
<i>E. Coli.</i>		Absent

4 Test Method

Unless otherwise noted, all reagents used in this standard are analytical purity and water is distilled water or equivalent purity of water.

4.1 Determination of activity of α -glucosidase

4.1.1 Principle

α -glucosidase reacts with substrate of α -D-methylglucoside to produce glucose, and the glucose reacts with 4-aminoantipyrin that contains glucose oxidase and peroxydase, and with phenol reagent, which is a color development reaction. Use the color development reaction to quantitatively determine the activity of α -glucosidase. The chemical reaction is as follows:

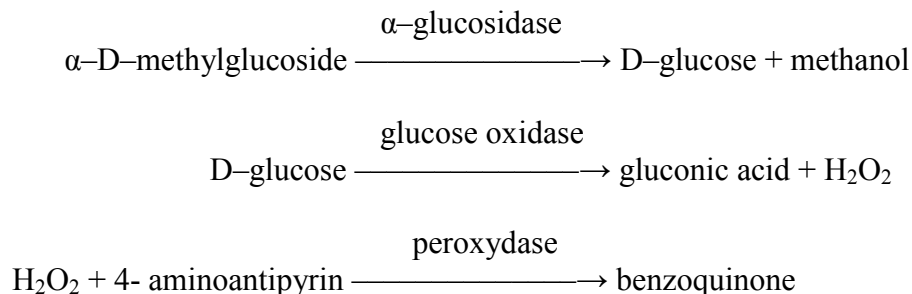

4.1.2 Reagents and solutions

- a) 0.1 mol/l of acetic acid solution: 6.0 g of acetic acid (CH_3COOH) is dissolved in water and diluted to 1000 ml;
- b) 0.1 mol/l of sodium acetate solution: 8.20 g of sodium acetate (CH_3COONa) is dissolved in water and diluted to 1000 ml;
- c) 0.02 mol/l of acetic acid–sodium acetate buffer solution (pH 5.0)
 - 20 ml of 0.1 mol/l acetic acid solution is dissolved in water and diluted to 100 ml (reagent A);
 - 20 ml of 0.1 mol/l sodium acetate solution is dissolved in water and diluted to 100 ml (reagent A);
 - Mix reagent A and B, and adjust pH value to 5.
- d) Tris–phosphoric acid buffer solution (pH 7.2): 36.3 g of trihydroxymethyl aminomethane [$\text{H}_2\text{NC}(\text{CH}_2\text{OH})_3$] and 50 g of monosodium orthophosphate dehydrate ($\text{NaH}_2\text{PO}_4 \cdot 2\text{H}_2\text{O}$) are dissolved in 900 ml of water, pH is adjusted to 7.2 with 2 mol/l of hydrochloric acid solution, and diluted with water to 1,000 ml;
- e) 0.4% of 4-aminoantipyrin solution: 200 mg of 4-aminoantipyrin ($\text{C}_{11}\text{H}_{13}\text{ON}_3$) is dissolved in water and diluted to 50 ml;
- f) 5% of phenol solution: 5 g of phenol ($\text{C}_6\text{H}_5\text{OH}$) dissolved in 60 °C of water, the solution is cooled down to room temperature and then diluted with water to 100 ml;
- g) Chromogenic agent of 4-aminoantipyrin–phenol: 550 unit of Glucose oxidase (5 mg of glucose oxidase “Amano” 2) and 125 unit of peroxydase (0.76 mg 165 T/mg of peroxydase

“Amano” 2) are added in 40 ml of Tris–phosphoric acid buffer solution (pH 7.2), and 1 ml of 0.4% 4–aminoantipyrin solution and 1.4 ml of 5% phenol solution are then added in it, and diluted to 50 ml with Tris–phosphoric acid buffer solution (pH 7.2). It is prepared just before use;

- h) Substrate solution: 2.0 g of α –methylglucose ($C_7H_{14}O_6$) is dissolved in 50 ml of water, and diluted with water to 100 ml (stabilized for 2 weeks at 5–15 °C).

4.1.3 Test method

4.1.3.1 Preparation of the sample solution

For 0.5 ml of enzyme solution, it $A_{60}-A_0$ is within range of 0.15–0.32: Take 1 ml of enzyme preparation, add it to a suitable volumetric flask, and dilute to the mark with cold water. Shake well.

Example: α –glucosidase L “Amano”: [n = 300] dilute 1 ml \longrightarrow 300 ml.

4.1.3.2 Measurement

Add 1 ml of substrate solution (4.1.2. h) and 1 ml of 0.02 mol/l acetic acid–sodium acetate buffer solution (pH 5.0) (4.1.2. c) into a test tube (15 mm X 150 mm), and put on the constant temperature water bath at (40 ± 0.5) °C for 10 min. Then add 0.5 ml of sample dilute solution (4.1.3.1). Shake well. Put in the constant temperature water bath at (40 ± 0.5) °C for 60 min. The test tube is then put in boiling water bath to heat for 5 min, and rapidly cool down with flowing water. Transfer 0.1 ml of the solution into test tube, and add 3 ml of 4–aminoantipyrin–phenol (4.1.2) in the tube. Shake well. This tube is placed in constant temperature water bath at (40 ± 0.5) °C for 20 min. Measure the absorbency A_{60} at 500 nm of wave length.

Bland: Add 1 ml of 0.02 mol/l acetic acid–sodium acetate buffer solution (pH 5.0) (4.1.2. c) and 0.5 ml of sample dilute solution (4.1.3.1) into a test tube (15 mm X 150 mm), and shake well. Put the test tube to boiling water bath to heat for 5 min, and rapidly cool down with flowing water. Then add the substrate solution (4.1.2. h). Shake well. Transfer 0.1 ml of the solution into a test tube (15 mm X 150 mm), and then add 3 ml of 4–aminoantipyrin–phenol (4.1.2) in the tube. Shake well. Place this tube in constant temperature water bath at (40 ± 0.5) °C for 20 min. Measure the absorbency A_0 at 500 nm of wave length.

Accurately weigh 1.000g of glucose that is dried at 105 °C for 6 h, dissolve in 100 ml of water. Measure 1 ml, 2 ml, 3 ml, 4 ml, 5 ml of the solution and dilute to 100 ml, respectively (1 ml of the solution contains 100 μ g, 200 μ g, 300 μ g, 400 μ g and 500 μ g of glucose, respectively).

Add 0.1 ml of the above glucose standard solution and 3 ml of 4–aminoantipyrin–phenol into test tube (15 mm X 150 mm), respectively. Shake well. Place the test tubes in constant temperature

water bath at (40±0.5) °C for 20 min. Measure absorbencies of A_{S10} , A_{S20} , A_{S30} , A_{S40} and A_{S50} at 500 nm of wave length, respectively.

Blank: The glucose standard solution is replaced by water, and the absorbency of blank A_{S0} is measured according the above method.

4.1.4 Expression of analytical result

Under the test condition, the enzyme amount used to produce 1 µg of glucose in 2.5 ml of mixture reacted for 60 min, is defined as one unit of activity of α–glucosidase.

4.1.4.1 When difference of absorbency is 1.000, the relative glucose amount G (µg) is calculated as formula (1):

$$G = \frac{\frac{10}{A_{S10} - A_{S0}} + \frac{20}{A_{S20} - A_{S0}} + \frac{30}{A_{S30} - A_{S0}} + \frac{40}{A_{S40} - A_{S0}} + \frac{50}{A_{S50} - A_{S0}}}{5} \dots\dots\dots (1)$$

4.1.4.2 Activity of α–glucosidase is calculated as formula (2):

$$\text{Activity of } \alpha\text{-glucosidase (U/ml)} = (A_{60} - A_0) \times G \times \frac{2.5}{0.1} \times \frac{n}{0.5} \dots\dots\dots (2)$$

Where:

A_{60} – Absorbency of the sample reaction solution;

A_0 – Absorbency of the blank solution;

G – When difference of absorbency is 1.000, the relative glucose amount G,µg. See formula (1);

2.5 – Total volume of the reaction system, ml;

0.1 – Sampling amount in the reaction system, ml;

n – Dilution multiple of enzyme sample;

0.5 – Adding amount of enzyme sample in the reaction system, ml.

4.1.5 Allowable deviation

The relative deviation is not greater than 5% in duplicate tests.

4.2 Determination of activity of amylase

4.2.1 Principle

The enzyme reacts with starch solution to produce reducing sugar. Then Fehling's solution (4.2.2. f) is added, in heating condition, to produce cuprous oxide precipitate quantitatively. After potassium iodide and sulfuric acid, iodine is formed, which is immediately titrated using sodium thiosulfate solution.

4.2.2 Reagents and solutions

- a) 30% of potassium iodide solution: 150 g of potassium iodide is dissolved in 350 ml of water, and preserved in brown bottle. Avoid direct sunlight;
- b) 25% of sulfuric acid solution: 125 g of sulfuric acid is dissolved in 375 ml of water;
- c) 0.05 mol/l of sodium thiosulfate solution: 500 ml of 0.1 mol/l sodium thiosulfate stock that is used for quantitative analysis is diluted with cold water that was previously boiled to 1000 ml. After preparation, calibrate the solution and obtain the concentration correction factor f ;
- d) 1 mol/l of acetic acid–sodium acetate buffer solution (pH 4.5): 1 mol/l sodium acetate solution is added in 1 mol/l acetic acid solution, and pH value is adjusted to 4.5;
- e) Soluble starch solution (pH 4.5): After soluble starch (reagent grade) is dried at 105 °C for 4 h, it is weighed and moisture content is calculated. Then, according to the moisture content, 0.5 g of soluble starch (dry basis) is weighed, and slowly added in 50 ml of boiling water, boiled for 5 min, then cooled down by water. Add 5 ml of 1 mol/l acetic acid-sodium acetate buffer solution, and dilute to 100 ml;
- f) Fehling's solution:
 - Copper solution: 34.66 g of copper sulfate is dissolved in water and diluted to 500 ml;
 - Potassium sodium tartrate solution: 173 g of potassium sodium tartrate and 50 g of sodium hydroxide are dissolved in water and diluted to 500 ml;
 - Accurately take same volume of the copper solution and the alkaline, and is thoroughly mixed before use.

4.2.3 Test method

4.2.3.1 Preparation of the sample solution

The enzyme sample is diluted with water, so value of $(T_0 - T_{30}) \times f \times 1.62$ of the enzyme solution is located in range of 3 – 3 mg of glucose amount.

Example: Glucosidase: [$n=100$] dilute 1 ml \longrightarrow 100 ml.

4.2.3.2 Measurement

Add 10 ml of soluble starch solution (4.2.2. e) into Erlenmyer triangular flask, and put in constant temperature water bath at $(40 \pm 0.5)^\circ\text{C}$ for 10 – 15 min, and then add 1 ml of the sample dilute solution (4.2.3.1). After accurately heat for 30 min, add 4 ml of Fehling's solution (4.2.2. f) to inactivate the enzyme. Heat the triangular flask using gas burner (or electric stove) for 2 min, then immediately put in cold water for cooling. Add 2 ml of 30% potassium iodide solution (4.2.2. a) and 2 ml of 25% sulfuric acid solution (4.2.2. b), and then titrate the free iodine using 0.05 mol/l of sodium thiosulfate solution (4.2.2. c) to the end point T_{30} (ml), where blue color is vanished.

Blank test: The enzyme solution is replaced by water, and put into another triangular flask. Measure the blank value T_0 (ml) according to the above operation procedure. When the titration is closed to end point, add 1-2 drops of 1% soluble starch solution [using soluble starch (reagent grade, prepared separately), until reach end point where blue color is vanished.

4.2.4 Expression of analytical result

Under the test condition, enzyme amount used to produce 10 mg of glucose in the reaction solution is defined as one unit of activity of amylase.

4.2.4.1 Activity of the enzyme is calculated following formula (3):

$$\text{Activity of amylase (U/ml)} = (T_0 - T_{30}) \times f \times 1.62 \times \frac{1}{10} \times n \quad \dots\dots\dots (3)$$

Where:

T_{30} – Volume of sodium thiosulfate standard solution consumed during the titration of enzyme reaction solution, ml;

T_0 – Volume of sodium thiosulfate standard solution consumed during the titration of blank solution, ml;

f – The correction factor of concentration of 0.05 mol/l sodium thiosulfate solution;

1.62 – Coefficient;

1/10 – Constant number of this test method (reducing sugar that is equivalent to 10 mg glucose);

n – Dilution multiple of enzyme sample.

4.2.5 Allowable deviation

The relative deviation is not greater than 5% in duplicate tests.

4.3 Determination of pH

Test according to the test method in QB/T 1803–1993.

4.4 Determination of arsenic

Test according to GB/T 8450.

4.5 Determination of lead

Test according to GB/T 8449.

4.6 Determination of heavy metal

Test according to GB/T 8451.

4.7 Determination of total count of bacteria

Test according to GB 4789.2.

4.8 Determination of *Coliform*

Test according to GB 4789.3.

4.9 Determination of *Salmonella*

Test according to GB 4789.4.

4.10 Determination of *Escherichia*

Test according to GB 4789.6.

5 Inspection Rules

5.1 Product must be tested by department of quality inspection and passed. Only the product attached with certificate can enter warehouse or delivery.

5.2 The batch is the product that is produced in same tank production, and packaged for delivery.

5.3 Sampling method

2 different types of sampling methods are used for physicochemical test and microbiological test of finished product, respectively.

5.3.1 Sampling for physicochemical analysis of finished product

Take sample from fermentation tank. Start agitator in the tank before sampling, stir the liquid enzyme for at least 12 h, clean the sampling valve using worm water, then wash the valve using

100 ml of enzyme liquid discharged from the tank. Discharge 80 ml of the enzyme liquid from the tank into glass bottle, and put it into refrigerator for physicochemical test.

5.3.2 Sampling for microbiological analysis of finished product

Take sample from fermentation tank. Start agitator in the tank before sampling, stir the liquid enzyme for at least 4 h, clean the sampling valve using worm water, then wash the valve using iodine solution, then discharge 100 ml of enzyme liquid from the tank to wash off the iodine solution residue in the valve. Discharge 80 ml of the enzyme liquid from the tank into septic glass bottle, and put it into refrigerator for microorganism test.

5.4 Activity of α -glucosidase, activity of amylase, pH, and microbiological index are mandatory testing items. Arsenic, lead and heavy metal are type test items, and need to be tested once of half year. If one of the items in the testing items is not passed the requirement of this standard, the sampling amount should be doubled, and then the unqualified item is retested. If still not passed, the entire batch of product is judged as not passing the requirements of this standard.

5.5 When dissent regarding the quality of product existed between the parties of supplier and customer, and need to arbitrate, so the arbitration agency should be chosen by both parties who have reach consensus. During arbitration, arbitration analysis must be conducted according to the test methods specified in this standard.

6 Labeling, packaging, transportation and storage

6.1 Labeling

Labeling must firmly stick on the package of product. Labeling contents include: manufacturer name, manufacturing address, product name, trade mark, product specification, batch No., production date, shelf-life, main parameters of product, net content, and product standard No., and mark of “food additive” typeface on the label. Certificate of product is attached to the product.

6.2 Packaging

6.2.1 Inner package is 20 L of polyethylene barrel.

6.2.2 Outer package is paper carton or steel barrel with coating inside.

6.3 Transportation

Products should be handled carefully, cannot be mixed with other packages and cannot be transported with toxic, hazardous, and caustic goods. Prevent from rain and strong sunlight.

6.4 Storage

The product is stored in cool and dry indoor place at 15–25 °C, and prevent from mixed storage with toxic, hazardous, perishable and contaminative goods.

6.5 Shelf-life

The shelf-life of the product is 3 months when product is compliance to the conditions of storage with package intact, and package is unopened. When exceeding shelf-life, the activity of enzyme is possible decreased, but it still can be used with increased the amount of use.

Appendix J

GB 1886–2008

Food Additive – Sodium Carbonate

ICS 67.220.20
X 42



National Standard of the People's Republic of China

GB 1886-2008
Replace GB 1886-1992

Food Additive – Sodium Carbonate

Issued on: June 25, 2008

Implemented on: January 1, 2009

Issued by: **General Administration of Quality Supervision, Inspection and
Quarantine of the People's Republic of China; and
Standardization Administration of the People's Republic of China**

Foreword

In this standard, the Chapter 4 and 7 are mandatory, the rest of them are recommendatory.

This standard is not equivalent to *Sodium Carbonate* specified in Joint Expert Committee of Food Additive (JECFA) 2002 (English version), Food and Agriculture Organization/World Health Organization (FAO/WHO).

This standard replaces GB 1886-1992 *Food Additive Sodium Carbonate*.

The major changes between this standard and GB 1886-1992 are as following:

- Add 97.9% of total alkali content (wet basis) (Sec. 4.2 in this standard);
- Change iron (as Fe) content from wet basis to dry basis and the value from 0.004% to 0.003% (Chapter 3, Sec. 4.4.5 in 1992 Edition; Sec. 4.2, 5.7.5 in this standard);
- Withdraw ignition loss item (Chapter 3 in 1992 Edition);
- Change water-insoluble content from 0.040% (dry basis) to 0.03% (Chapter 3, 1992 Edition; Sec. 4.2 in this standard);
- Add Wet Basis Test Method for total alkali content (Sec. 5.5.4.2 in this standard);
- Add sodium sulfide solution in Determination of Heavy Metal (Sec. 4.5, 1992 Edition; Sec. 5.8 in this Edition);
- Add Silver Diethyldithiocarbamate Colorimetry as a Determination Method of Arsenic, and set it as the Arbitration Method (Sec. 5.9 in this Edition);
- Add Method of Gooch Crucible with Asbestos Paper in Determination of Water-insoluble Matter. Method of Gooch Crucible with Acid-washed Asbestos as the Arbitration Method (Sec. 4.8, 1992 Edition; Sec. 5.11, this Edition);
- Add specification for small package (Sec. 8.1.3 in this Edition).

This standard was proposed by China Petroleum and Chemical Industry Association (CPCIA).

This standard is under the jurisdictions of both Subcommittee of Inorganic Chemical Industry, National Technical Committee 63 on Chemical of Standardization Administration of China (SAC/TC 63/SC1) and National Technical Committee 11 on Food Additives of Standardization Administration of China (SAC/TC 11).

Drafting organization for this standard: Tianjin Chemical Research and Design Institute; Tianjin Soda Plant; Tangshan Sanyou Chemical Industries Co., Ltd.; Tongbai Anpeng Alkaline Mineral Limited Liability Company; Shuanghe Alkaline Corp., Xinjiang Chemical Industry (Group) Co.,

Ltd.; Xilin Gol Sunite Alkali Co., Ltd.; Lianyungang Soda Plant, Nanjin Chemical Co., Ltd., China Petrochemical Corp.; Shandong Haihua Group Soda Plant; Sichuan Zigong Honghe Chemical Industry (Group) Co., Ltd.; Dahua Group Co., Ltd.; Qingdao Soda Ash Industrial Co., Ltd.; Jiangsu Debang Chemical Industry Group Co., Ltd.; and Hubei Yihua Group Co., Ltd.

Principal drafters for this standard: Yong Lu; Yan Wang; Anli Cha; Qiuli Xie; Bin Wang; Wenyan Ma; Wenfa Geng; Shuxiang Sun; Lan Jin; Fuhang Wang; Yuan Wang; Chuanguo Yi, Xiaoqin Yang; and Youruo Liu.

The previous editions replaced by this standard:

— GB 1886-1983 and GB 1886-1992.

Food Additive – Sodium Hydroxide

1 Scope

This standard specifies the requirements, test methods, inspection rules, marking, labeling, packaging, transport and storage for food additive of sodium carbonate.

This standard is applicable to food additive of sodium carbonate that is used as acidity regulator and processing aid in food industry.

2 Normative Reference Standards

The following standards contain provisions which, through reference in this text, constitute provisions of this standard. For the dated references, subsequent amendments to (error corrections not included) or revisions of, any of these publications will be not applicable to this standard. However, the parties to agreements based on this standard are encouraged to investigate the possibility of applying the most recent editions of the standards. For undated references, the latest edition of the normative document referred to applies.

GB/T 191 – 2008 Packaging–Pictorial Marking for Handling of Goods (ISO 780:1997, MOD)

GB/T 3049–2006 General Method for Determination of Iron in Chemical Products in Industry 1,10–Phenanthroline monohydrate Spectrophotometry (ISO 6685, 1982, IDT)

GB/T 3050–2000 General Method for Determination of Chloride in Inorganic Chemical Products Potentiometric Titration

GB/T 3051– 2000 General Method for Determination of Chloride in Inorganic Chemical Products Mercurimetry

GB/T 6678 General Principles for Sampling Chemical Products

GB/T 6682–2008 Water for Analytical Laboratory Use – Specification and Test Methods (ISO 3696:1987, MOD)

GB/T 5009.76–2003 Determination of Arsenic in Food Additives

HG/T 3696.1 Inorganic Chemical Products: Preparations of Standard Volumetric Solutions for Chemical Analysis

HG/T 3696.2 Inorganic Chemical Products: Preparations of Impurity Standard Solutions for Chemical Analysis

HG/T 3696.3 Inorganic Chemical Products: Preparations of Reagent Solutions for Chemical Analysis

3 Molecular Formula and Relative Molecular Mass

Molecular formula: Na_2CO_3

Relative molecular mass: 105.99 (based on International Relative Atomic Mass 2007)

4 Requirements

4.1 Appearance: Food additive of solid sodium carbonate is white crystal powder.

4.2 Food additive of solid sodium carbonate must comply with the requirements in Table 1.

Table 1 Requirements

Item	Index
Total alkali content (as Na_2CO_3) (dry basis), $w\%$ \geq	99.2
Total alkali content (as Na_2CO_3) (wet basis), $w\%$ \geq	97.9
Chloride (as NaCl) (dry basis), $w\%$ \leq	0.70
Iron (as Fe) (dry basis), $w\%$ \leq	0.0035
Heavy metals (as Pb), $w\%$ \leq	0.0010
Arsenic (As), $w\%$ \leq	0.0002
Water-insoluble matter (dry basis), $w\%$ \leq	0.03

5 Test Methods

5.1 Safety warning

Some of reagents used in the test in this standard have toxicity or causticity, so that it must be cautious when operating them. If by any chance the chemicals spill to skin, must rinse out immediately using water. In severe scenario, one must be treated. When using volatile acid, it should be handled in chemical hood.

5.2 General provisions

Unless otherwise noted, all reagents used in this standard are analytically purity and water is third grade of water specified in GB/T 6682-2008.

Unless otherwise noted, all standard solutions, impurity standard solutions, preparations of reagents are prepared in accordance with requirements specified in HG/T 3696.1, HG/T 3696.2, and HG/T 3696.3.

5.3 Appearance identification

Identify the sample by visual under natural light.

5.4 Identification

5.4.1 Reagents and materials

5.4.1.1 Hydrochloric acid;

5.4.1.2 Magnesium sulfate solution: 120 g/L;

5.4.1.3 Saturated calcium oxide solution:

Weigh 3 g calcium oxide with precision to 0.1 g, place it into a reagent bottle and then add 1000 ml water. Close the plug and shake it thoroughly. Then put statically for clarification. The supernatant liquor is ready for use.

5.4.1.4 Glass pod with platinum filament ring.

5.4.2 Identification method

5.4.2.1 Preparation of the test solution

Weigh 20 g sample with precision to 0.1 g, put it into a beaker, and then add 100 ml water to dissolve the sample.

5.4.2.2 Soak the platinum filament ring with hydrochloric acid, and burn to colorless on flame. Then dip small amount of test solution and burn it on flame, the flame presents bright yellow color.

5.4.2.3 Add hydrochloric acid into the test solution, so carbon dioxide is released, which is then introduced to the saturated calcium oxide solution to form white turbid solution at first, and become clear when carbon dioxide is continually introduced.

5.4.2.4 Add magnesium sulfate solution into the test solution, it becomes white precipitate.

5.5 Determination of total alkali

5.5.1 Abstract of the method

The test solution is titrated by the standard solution of hydrochloric acid, with bromocresol green-methyl red as an indicator.

5.5.2 Reagents

5.5.2.1 Hydrochloric acid standard titration solution: $c(\text{HCl})$ approximate 1 mol/l;

5.5.2.2 Bromocresol green-methyl red indicator solution.

5.5.3 Apparatus and equipment

5.5.3.1 Weighing bottle ($\phi 30$ mm X 25 mm) or ceramic crucible (volume 30 ml);

5.5.3.2 Electric oven or high temperature furnace: control temperature at (250 – 270) °C.

5.5.4 Analysis Procedure

5.5.4.1 Determination of total alkali (dry basis)

Weigh 1.7 g sample that was dried to constant weight at temperature of (250 – 270) °C previously, with precision to 0.0002 g, put it into a conical beaker and use 50 ml water to dissolve it. Add 10 drops of bromocresol green-methyl red solution as an indicator, and then titrate the solution using hydrochloric acid standard solution to the point that the color of the solution is changed from green to dark red, then boil the solution for 2 min, cool it down, and then continually titrate the solution to the end-point with dark red color. Meanwhile, conduct the blank test.

5.5.4.2 Determination of total alkali (wet basis)

Weigh 1.7 g sample with precision to 0.0002 g, put into a conical beaker, and dissolve with 50 ml water. Add 10 drops of bromocresol green-methyl red solution as an indicator, and titrate the solution using hydrochloric acid standard solution to the point that the color of the solution is changed from green to dark red, then boil the solution for 2 min, cool it down, and then continually titrate it to the end-point with dark red color. Meanwhile, conduct the blank test.

5.5.5 Calculation of the result

Total alkali is expressed as mass fraction of sodium carbonate (Na_2CO_3), w_1 , its value is expressed as %, and is calculated in accordance with formula (1):

$$w_1 = \frac{c[(V_1 - V_0)/1\ 000]M}{m} \times 100 \quad \dots\dots\dots (1)$$

Where:

c – Accurate value of concentration of the hydrochloric acid standard solution, the unit is mol/l;

V_1 – Volumetric value of consumption of hydrochloric acid standard solution used in titration of the test solution, the unit is ml;

V_0 – Volumetric value of consumption of the hydrochloric acid standard solution used in titration of the blank solution, the unit is ml;

m – Value of the mass of the sample, the unit is g;

M – Value of the mole mass of sodium carbonate ($1/2\text{Na}_2\text{CO}_3$), the unit is g/mol ($M = 53.0$)

Measurement result is expressed as an average arithmetical value of replicate determinations. The difference between the absolute values of the results of the two parallel tests is not greater than 0.2%.

5.6 Determination of chloride

5.6.1 Potentiometric titration

5.6.1.1 Abstract of the method

See GB/T 3050–2000, Chapter 2.

5.6.1.2 Reagents

5.6.1.2.1 Nitric acid solution: 1+1;

5.6.1.2.2 Saturated potassium nitrate solution;

5.6.1.2.3 Bromjophenol blue solution: 1 g/l ethanol solution;

5.6.1.2.4 Sodium chloride standard solution: $c(\text{NaCl}) = 0.05 \text{ mol/l}$.

Weigh 2.9225 g sodium chloride that was dried to constant weight at 500 – 600 °C previously, with precision to 0.0002 g, place it into a beaker and dissolve with water, then transfer the solution into a 1000 ml volumetric flask, add water to the mark line. Shake thoroughly.

5.6.1.2.5 Silver nitrate standard solution: $c(\text{AgNO}_3)$ is about 0.05 mol/l:

a) Preparation: Weigh 8.75 g silver nitrate with precision of 0.01 g, dissolve in 1000 ml water, and shake well. Store this solution in a brown bottle.

b) Measurement: Take 5 ml sodium chloride standard solution by pipette, put into a 100 ml beaker, and then adds 40 ml water. Put electromagnetic stirrer into the solution, and place the beaker on electromagnetic agitator, and then power on the agitator. Add 2 drops of bromjophenol blue solution and the nitric acid solution until the solution is turned to yellow color. Insert the measuring electrode and reference electrode into the solution, connect electrometer and adjust to 0 point, and record the initial potential value. Silver nitrate standard solution is used for titration, firstly add 4.00 ml and then add 0.1 ml successively. Record total volume after silver nitrate standard solution is added each time and correspondent electric potential value E . Calculate the difference ΔE_2 between continually increased electric potential values of ΔE_1 and increased electric potential values of ΔE_1 . The maximum value of ΔE_1 is the end-point of titration, and record one more electric potential value E after the titration end-point.

Recording format see GB/T 3050-2000, Appendix C.

Volume V (ml) of consumption of the silver nitrate standard solution when titrated to end-point is calculated in accordance with formula (2):

$$V = V_0 + \frac{b}{B}V_1 \quad \dots\dots\dots (2)$$

Where:

V_0 – Volume value of the silver nitrate standard solution added before to reach maximum value of electric potential increment value ΔE_1 , the unit is milliliter (ml);

V_1 – Volume value of the silver nitrate standard solution last added before to reach maximum value of electric potential increment value ΔE_1 , the unit is milliliter (ml);

$b - \Delta E_2$ the last positive value;

$B - \Delta E_2$ the sum of absolute values of the last positive value and the first negative value.

c) Calculation: Accurate value of concentration of the silver nitrate standard solution c (AgNO_3) (mol/l) is calculated in accordance with formula (3):

$$c = \frac{c_2 V_2}{V} \quad \dots\dots\dots (3)$$

Where:

c_2 – Accurate value of the concentration of sodium chloride standard solution, the unit is mol/l;

V_2 – Volume of the sodium chloride standard solution taken for titration, the unit is ml;

V – Volume of consumption of the sodium chloride standard solution during titration, the unit is ml.

5.6.1.3 Apparatus and equipment

See GB/T 3050-2000, Chapter 5.

5.6.1.4 Analysis procedure

Weigh 1 g sample with precision to 0.01 g, place it into a 100ml beaker and dissolve using 40 ml water. Perform the following operations according to Sec. 5.6.1.2.5, beginning from “put electromagnetic stirrer” to “record one more electric potential value E after the titration end-point”, except for not firstly adding 4.00 ml silver nitrate standard solution. Meanwhile, conduct the blank test.

5.6.1.5 Calculation of the result

Chloride is expressed as mass fraction of sodium chloride (NaCl), w_2 , the value is expressed as %, and calculate in accordance with formula (4):

$$w_2 = \frac{c[(V - V_0)/1000]M}{m(100 - w_0)/100} \times 100 \quad \dots\dots\dots (4)$$

Where:

- c – Accurate value of concentration of silver nitrate standard solution, the unit is mol/l;
- V – Volume of consumption of silver nitrate standard solution in titration, the unit is ml;
- V_0 – Volume of consumption of silver nitrate standard solution in blank test, the unit is ml;
- w_0 – Value of mass fraction of ignition loss measured in Sec. 6.9, expressed as %;
- m – Value of sample mass, the unit is g;
- M – Value of mole mass of sodium chloride (NaCl), the unit is g/mol ($M = 58.44$).

Measurement result is expressed as an average arithmetical value of replicate determinations. The difference between the absolute values of the results of the two parallel tests is not greater than 0.02%.

5.6.2 Mercurimetry (Arbitration Method)

5.6.2.1 Abstract of the method

See GB 3051-2000, Chapter 3.

5.6.2.2 Reagents and materials

5.6.2.2.1 Nitric acid solution: 1+1;

5.6.2.2.2 Nitric acid solution: 1+7;

5.6.2.2.3 Sodium hydroxide solution: 40 g/l;

5.6.2.2.4 Mercury nitrate standard titration solution: $c [1/2\text{Hg}(\text{NO}_3)_2 \cdot \text{H}_2\text{O}]$, about 0.05 mol/l;

5.6.2.2.5 Bromjophenol blue solution: 1 g/l;

5.6.2.2.6 Diphenyl carbazone solution: 5 g/l.

5.6.2.3 Apparatus and equipment

Titration tube: the division value is 0.01 ml.

5.6.2.4 Analysis procedure

5.6.2.4.1 Preparation of the reference Solution

Add 40 ml water and 2 drops of bromjophenol blue solution into a 250 ml conical beaker. Dropwise add the nitric acid solution (5.6.2.2.1) to the solution until the color is changed from blue to yellow and excess 2 to 3 drops. Then add 1 ml of diphenyl carbazone solution as indicator, and titrate by the mercury nitrate standard solution to the point that color is changed from yellow to fuchsia. Record the volume of the mercury nitrate standard solution used. This solution is prepared just before use.

5.6.2.4.2 Determination of the sample

Weigh 2 g sample with precision to 0.01g, place it into a 250 ml conical beaker and dissolve it with 40 ml water. Add 2 drops of bromjophenol blue solution an indicator, and dropwise add the nitric acid solution (5.6.2.2.1) to neutralize it as yellow color, and then dropwise add sodium hydroxide solution to blue color. After adding the nitric acid solution (5.6.2.2.2) to make the sample solution to yellow color, continually add excess 2 – 3 drops of the nitric acid solution. Add 1 ml of diphenyl carbazone solution as an indicator; titrate using the mercury nitrate standard solution to the end-point that color is changed from yellow to fuchsia that is same as the reference solution.

Preserve the mercury waste after titration, and handle it according to GB 3051-2000, Appendix D.

5.6.2.5 Calculation of the result

Chloride is expressed as mass fraction of sodium chloride (NaCl), w_2 , its value is expressed as %, and is calculated in accordance with formula (5):

$$w_2 = \frac{c[(V - V_0) / 1\ 000]M}{m(100 - w_0) / 100} \times 100 \quad \dots\dots\dots (5)$$

Where:

c – Accurate value of concentration of the mercury nitrate standard solution, the unit is mol/l;

V – Volume of consumption of the mercury nitrate standard solution in titration, the unit is ml;

V_0 – Volume of consumption of the mercury nitrate standard solution in preparation of reference solution, the unit is ml;

w_0 – Value of mass fraction of ignition loss measured in Sec. 6.9, the unit is %;

m – Value of sample mass, the unit is g;

M – Value of mole mass of sodium chloride (NaCl), the unit is g/mol ($M = 58.44$).

Measurement result is expressed as an average arithmetical value of replicate determinations. The difference between the absolute values of the results of the two parallel tests is not greater than 0.02%.

5.7 Determination of iron

5.7.1 Abstract of the method

Same as GB/T 3049-2006, Chapter 3.

5.7.2 Reagents

Same as GB/T 3049-2006, Chapter 4.

5.7.3 Apparatus and equipment

Same as GB/T 3049-2006, Chapter 5.

5.7.4 Analysis procedure

5.7.4.1 Preparation of Sample Solution

Weigh 10 g sample with precision to 0.01 g, place it into a beaker, and moisten it with small amount of water, and then cover the beaker with watch glass. Dropwise add 35 ml hydrochloric acid solution (1+1), boil for 3 – 5 min and cool down (filtrated if necessary). Transfer the solution into a 250 ml of volumetric flask and dilute it to the mark line with water. Shake well.

5.7.4.2 Preparation of blank test solution

Measure 7 ml of hydrochloric acid solution (1+1) and put into a 100 ml of beaker. Add ammonia solution (2+3) to neutralize to neutral (using precise pH test paper).

5.7.4.3 Preparation of working standard curve

See GB/T 3049-2006, Chapter 6.3. Choose 4 or 5 cm absorption cell and the corresponding volume of iron standard solution.

5.7.4.4 Measurement

Take 50 ml of test solution and 50 ml of blank test solution by pipettes, and adjust to pH 2 (precise pH test paper) using ammonia solution (1+8) or hydrochloric acid solution (1+3), respectively. Transfer the solutions into 100 ml of volumetric flasks, respectively. The following operation is conducted according to GB/T 3049-2000, Chapter 6.4. Absorbency values are measured for the test solution and blank solution, respectively.

5.7.5 Calculation of the result

Iron content is expressed as mass fraction of iron (Fe) w_3 , the value is expressed as %, and calculated according to formula (6):

$$w_3 = \frac{(m_1 - m_0) \times 10^{-3}}{m(100 - w_0) \left(\frac{50}{250}\right)/100} \times 100 \quad \dots\dots\dots (6)$$

Where:

m_1 – Mass of iron obtained from working standard curve by absorbency measured from the test solution, the unit is mg;

m_0 – Mass of iron obtained from working standard curve by absorbency measured from the blank solution, the unit is mg;

m – Mass of the sample, the unit is g;

w_0 – Mass fraction of ignition loss measured according to Sec. 6.9, expressed as %.

Measurement result is expressed as an average arithmetical value of replicate determinations. The difference of the absolute values of the results of the two parallel tests is not greater than 0.0005%.

5.8 Determination of heavy metal

5.8.1 Abstract of the method

Under weak acidic condition (pH 3 – 4), heavy metal ion in the sample reacts with hydrogen sulfide to produce brownish-black color, and then compare it with the lead standard solution that is treated at same procedure as above.

5.8.2 Reagents

5.8.2.1 Hydrochloric acid solution: 1+4;

5.8.2.2 Ammonia solution: 1+2;

5.8.2.3 Ethanol solution: 1+15;

5.8.2.4 Sodium sulfide solution or hydrogen sulfide solution;

5.8.2.5 Lead standard solution: 1 ml contains 0.010 mg of lead (Pb), prepared before use;

Take 10 ml lead standard solution prepared that is prepared according to HG/T 3696.2, put into a 100 ml volumetric flask, and dilute to the mark line by water. Shake up.

5.8.2.6 Phenolphthalein solution: 10 g/l.

5.8.3 Analysis procedure

5.8.3.1 Preparation of the test solution

Weigh 2.00 ± 0.01 g sample and put into a 100 ml beaker. Add 5 ml water and then cover a watch glass on the beaker. Slowly add 17 ml of hydrochloric acid into the beaker and boil for 5 min. After cooling down, add 1 drop of phenolphthalein solution as an indicator, and neutralize to light red color using ammonia solution.

Transfer the above solution into a 50 ml of colorimetric tube, add 2 ml ethanol solution and 10 ml sodium sulfide or hydrogen sulfide, and then dilute to the mark line using water. Shake up. Put the solution in dark place for 10 min, and then compare with the standard comparison solution, the color must not be deeper than the standard.

5.8.3.2 Preparation of standard comparison solution

Transfer 2 ml of lead standard solution into a 100 ml beaker using pipette. According to above 5.8.3.1, beginning from “add 5 ml water”, conduct the operations of the standard comparison solution and the test solution as the same procedure simultaneously.

5.9 Determination of arsenic

Weigh (10.00 ± 0.01) g sample and place into a conical beaker. Moist the sample with water, and neutralize to neutral (using pH test paper) using hydrochloric acid, and then add excess 5 ml. Shake up. Transfer 2 ml of arsenic standard solution (1 ml contains $1 \mu\text{g}$ of As) by pipette into another conical beaker as a standard. Add 5 ml hydrochloric acid solution (1+3) to the test solution and arsenic standard solution, respectively. Then, conduct the procedures according to the first method of silver diethyldithiocarbamate colorimetry specified in Sec. 6.2, GB/T 5009-2003, or the second method of arsenic stain specified in Sec. 11, GB/T 5009.76-2003.

The method of silver diethyldithiocarbamate colorimetry is an arbitration method.

5.10 Determination of ignition loss

5.10.1 Abstract of the method

Heat the sample at (250 – 270) °C to constant weight. According to the loss of free moisture, water and carbon dioxide decomposed from sodium bicarbonate during heating, calculate ignition loss.

5.10.2 Apparatus and equipment

5.10.2.1 Weighing bottle: $\phi 30$ mm X 25 mm, or 30 ml of ceramic crucible;

5.10.2.2 Electric oven or high temperature furnace with temperature controlled at (250–270) °C.

5.10.3 Analysis procedure

Weigh 2 g sample using weighing bottle or ceramic crucible that is previous dried to constant weight at (250–270) °C, with precision to 0.002 g, and then put into electric oven or high temperature furnace to heat to constant weight at (250–270) °C.

5.10.4 Calculation of the result

Ignition loss is expressed as mass fraction, w_0 , its value is expressed as %, and calculated according to formula (7):

$$w_0 = \frac{m_1 - m_2}{m} \times 100 \quad \dots\dots\dots (7)$$

Where:

m_1 – Mass of the sum of sample and weighing bottle or ceramic crucible, the unit is mg;

m_2 – Mass of the sum of sample and weighing bottle or ceramic crucible after heating, the unit is mg;

m – Mass of the sample, the unit is g.

Measurement result is expressed as an average arithmetical value of replicate determinations. The difference between the absolute values of the results of the two parallel tests is not greater than 0.04%.

5.11 Determination of water-insoluble matter

5.11.1 Abstract of the method

Dissolve the sample in water at (50±5) °C. Water-insoluble matter is filtrated, washed and dried, and then weighed.

5.11.2 Reagents and materials

5.11.2.1 Hydrochloric acid solution: 1+3;

5.11.2.2 Anhydrous sodium carbonate solution: 100 g/l;

5.11.2.3 Phenolphthalein solution: 10 g/l;

5.11.2.4 Acid-washed asbestos:

Put adequate acid-washed asbestos in a beaker, add hydrochloric acid solution and boil for 20 min. The asbestos is then filtrated using Buchner funnel and washed to neutral (tested by phenolphthalein solution). Take out and put in a beaker, and then add water to prepare paste for future use.

5.11.2.5 Asbestos filter paper.

5.11.3 Apparatus and equipment

5.11.3.1 Gooch crucible: volume 30 ml;

5.11.3.2 Electric oven: temperature controlled at (110 ± 5) °C.

5.11.4 Analysis procedure

5.11.4.1 Arranging Gooch crucible

5.11.4.1.1 Gooch crucible with acid-washed asbestos (arbitration method)

Put Gooch crucible on a suction bottle. Lay down a layer of acid-washed asbestos equably on both of top and bottom sides of the sieve plate. Press the sieve plate using glass rod with a flat end to about 3 mm for each layer while suctioning. Then wash using (50 ± 5) °C of water until the filtrate does not contain asbestos fiber. Then, put the Gooch crucible in electric oven and dry at (110 ± 5) °C, and then weigh. Repeatedly wash and dry until to constant weight.

5.11.4.1.2 Gooch crucible with asbestos paper

Put Gooch crucible on a suction bottle; lay down 1 layer of asbestos paper on the bottom side of the sieve plate, and 2 layers of asbestos paper on the top side of the sieve plate. Press the sieve plate using glass rod with a flat end while suctioning. Wash the filter paper using water (50 ± 5) °C. Put the Gooch crucible in electric oven and dry at (110 ± 5) °C, and then weigh. Repeatedly wash and dry until to constant weight.

5.11.4.2 Measurement

Weigh about 40 g samples with precision to 0.01 g, and place into a beaker, and dissolve using 400 ml water at about 40 °C. Keep the solution at (50 ± 5) °C. Filtrate using Gooch crucible with constant weight, and wash using (50 ± 5) °C of water to the point that there is not red color presents in 20 ml of filtrate after 2 drops of phenolphthalein solution is added. Control the total volume of washing water to 800 ml. Then put the Gooch crucible in an electric oven at (50 ± 5) °C for drying until constant weight.

5.11.5 Calculation of the result

Water-insoluble matter is expressed as w_4 , its value expressed as % and calculated by formula (8):

$$w_4 = \frac{m_1}{m(100 - w_0)/100} \times 100 \quad \dots\dots\dots (8)$$

Where:

m_1 – Mass of water-insoluble matter, the unit is g;

m – Mass of sample, the unit is g;

w_0 – Mass fraction of ignition loss measured according to Sec. 6.9, the unit is %.

Measurement result is expressed as an average arithmetical value of replicate determinations. The difference between the absolute values of the results of the two parallel tests is not greater than 0.006%.

6 Inspection Rules

6.1 All items in this standard are delivery test, and must be inspected every batch.

6.2 A batch is defined as continuing production of food additive of sodium carbonate in one day, using the same production materials under the same processing conditions.

6.3 Sampling unit number is determined accordance to requirements specified in GB/T 6678. The sampler is perpendicularly inserted from the center of the bag to 3/4 deep of the product, where sample is taken. Mix the samples uniformly. Divide the sample to not less than 500 g using sample quartering. Put the sample into two clean and dry containers, respectively. Close the containers and label them with manufacturer name, product name, batch number, sampling date and sampling person. One is used for testing, and the other one is preserved for 3 months for future reference.

6.4 The department of quality supervision and inspection must conduct the tests of food additive of sodium carbonate in accordance to this standard. Manufacturer must ensure product of each batch delivered complies with the requirements specified in this standard.

6.5 If one of the testing items does not comply with the requirements specified in this standard, sample that is taken from 2 fold amount of packaged product must be retested. Even if only one item does not comply with the requirement in this standard, the entire batch is considered as disqualified.

7 Marking and Labeling

7.1 On the packaging container of food additive of sodium carbonate, labeling attached must be firm and clear. The label contents include manufacturer name, manufacturing address, product name, “food additive” typeface, net content, batch number or production date, production permit number, hygiene permit number, and this standard number, as well as “causticity” mark specified in GB 190-1990, “up” and “keep dry” marks specified in GB/T191-2008.

7.2 Food additive of sodium carbonate for each batch delivered must attach certificate of quality that includes manufacturer name, manufacturing address, product name, “food additive” typeface, net content, batch No. or production date, certificate of quality of the product that comply with

this standard, this standard number, production permit No., hygiene permit No., certificate of product is complied with this standard and this standard number.

8 Packaging, Transport and Storage

8.1 Food additive of sodium carbonate is packaged as the following manner:

8.1.1 Polywoven bag: Inner package uses food grade polyethylene bag, and manually tight using vinylon rope or other rope with similar quality, or tight using other similar manner. Welt the outer bag using vinylon string, suture is tidy, and needle pitch is uniform, no leak and jumping wire. Or align and crimp the bag mouths of inner and outer bags, and welt it using vinylon string, suture is tidy, and needle pitch is uniform, no leak and no jumping wire. Net content per bag is 40 kg or 50 kg.

8.1.2 Complex membrane bag package: Utilize food grade complex membrane bag and hem seam by using vinylon string or other with similar quality, suture is tidy, and needle pitch is uniform, no leak and no jumping wire. Net content per bag is 40 kg or 50 kg.

8.1.3 Small bag package: Utilize food grade polyethylene bag with thickness not less than 0.05 mm. Heat sealing and no leak. Net content per bag is 250 g or 500 g. Put a certain amount of small bags into polywoven bag or carton, the outer packages' properties and test methods must complies with related regulations.

8.1.4 Determine the package size and manner according to the requirements of customer.

8.2 During transportation, the package must prevent from rain, or damp and defile, and must inhibit to transport and store mixed with hazardous, toxic and other contaminated materials.

8.3 Store the food additive of sodium carbonate in a cool and circulated warehouse where is specially assigned for food additives. Put the product on cushion to prevent from dampening.

8.4 The shelf-life of food additive of sodium carbonate is 18 months. It can continue to use if it possesses acceptance certificate after expiration of the shelf-life.

Appendix K

GB 1897–2008

Food Additive – Hydrochloric Acid

ICS 67.220.20
X 42



National Standard of the People's Republic of China

GB 1897–2008
Replace GB 1897–1995

Food Additive – Hydrochloric Acid

Issued on: June 25, 2008

Implemented on: January 1, 2009

Issued by: **General Administration of Quality Supervision, Inspection and Quarantine of the People's Republic of China; and Standardization Administration of the People's Republic of China**

Foreword

The Chapter 4 and 7 in this standard are mandatory, the rest of them are recommendatory.

This standard is not equivalent to *Hydrochloric Acid* specified in US *Food Chemical Code*, 5th Edition [FCC (V): 2004].

This standard replaces GB 1897-1995 *Food Additive – Hydrochloric Acid*.

The major differences between this standard and GB 1897-1995 are as following:

- Enhance iron technical requirement (Sec. 3.2 in prior Edition; Sec. 4.2 in this Edition);
- Withdraw ignition loss item, add non-volatile matter item (Sec. 3.2 in prior Edition; Sec. 4.2 in this Edition);
- Withdraw the determination method of ignition loss, and add determination method of non-volatile matter (Sec. 4.7 in prior Edition; Sec. 5.10 in this Edition);
- Add the cycle period for type test and requirements for type test in special situation (Sec. 6.2 in this Edition).

This standard was proposed by China Petroleum and Chemical Industry Association (CPCIA).

This standard is under the jurisdictions both of Subcommittee of Inorganic Chemical Industry, National Technical Committee 63 on Chemical of Standardization Administration of China (SAC/TC 63/SC1) and of National Technical Committee 11 on Food Additives of Standardization Administration of China (SAC/TC 11).

Drafting organization for this standard: Hangzhou Co., Ltd.; Jinxi Chemical Industry Institute; Yunnan Salt & Salt Chemical Industry Co., Ltd.; Haohua Yuhang Chemical Co., Ltd.; Tianjin Dagu Chemical Industry Co., Ltd.; Shanghai Chlor-Alkali Chemical Co., Ltd.; Qingdao Haijing Chemical Group Co., Ltd.

Principal drafters for this standard: Peiyun Chen; Yuefang Jiang; Furong Li; Rongquan Wu; zhiqiang Liu; Shaotong Zhan; Jianfang Cao; Yingmin Zhang.

This standard was issued at first time in 1986, and first amended in 1995.

Food Additive –Hydrochloric acid

Warning — Hydrochloric acid has strong causticity. Handler must use adequate safety and health measures. Personnel who handle hydrochloric acid must wear protection glass, and acid-resistant gloves, etc.

1 Scope

This standard specifies the requirements, test methods, inspection rules, mark and label, package, transportation and storage for food additive of hydrochloric acid.

This standard is applicable to food additive of hydrochloric acid that is synthesized by chlorine and hydrogen, which then absorbed through water. This product is used for acidity adjustment in food processing and for process aid in food industry.

2 Normative Reference Standards

The following standards contain provisions which, through reference in this text, constitute provisions of this standard. For the dated references, subsequent amendments to (error corrections not included) or revisions of, any of these publications will be not applicable to this standard. However, the parties to agreements based on this standard are encouraged to investigate the possibility of applying the most recent editions of the standards. For undated references, the latest edition of the normative document referred to applies.

GB 190 – 2008 Package Labeling for Hazardous Goods

GB/T 191 – 2008 Packaging—Pictorial Marking for Handling of Goods (ISO 780:1997, MOD)

GB/T 601 – 2002 Chemical Reagent Preparation of Standard Titration Solution

GB/T 602 – 2002 Chemical Reagent Preparation of Standard Solution Used for Determining Impurity

GB/T 603 – 2002 Chemical Reagent Preparation of Formulation and Product Used in Test Methods

GB 2760 – 1996 Hygienic Standard for Uses of Food Additive

GB/T 6678 – 2003 General Principles for Sampling Chemical Products

GB/T 6680 – 2003 General Principles for Sampling Liquid Chemical Products

GB/T 6682 – 2008 Water for Analytical Laboratory Use – Specification and Test Methods (ISO 3696:1987, MOD)

3 Molecular Formula and Relative Molecular Mass

Molecular formula: HCl

Relative molecular mass: 36.46 (based on International Relative Atomic Mass 2007)

4 Requirements

4.1 Appearance: Colorless or light yellow and transparent liquid.

4.2 Food additive of hydrochloric acid must comply with the requirements in Table 1.

Table 1 Requirements

Item		Index
Total acidity (as HCl), <i>w</i>	≥	31.0
Iron (as Fe), <i>w</i>	≤	0.0005
Sulfate (as SO ₄ ²⁻), <i>w</i>	≤	0.007
Free chlorine (as Cl), <i>w</i>	≤	0.003
Reducing matter (as SO ₂), <i>w</i>	≤	0.007
Non-volatile matter, <i>w</i>	≤	0.05
Heavy metal (as Pb), <i>w</i>	≤	0.0005
Arsenic (As), <i>w</i>	≤	0.0001

5 Test Methods

5.1 Safety Caution

Some of reagents used in the test in this standard have toxicity or causticity, so that it must be cautious during operating. If by any chance the chemicals spill to skin, the one must rinse out immediately using water. In severe scenario, the one must be treated.

5.2 General specifications

Unless otherwise noted, all reagents used in this standard are analytical purity, and water is the third grade of water specified in GB/T 6682–2008. Unless otherwise noted, all standard solutions, impurity standard solutions, preparations of reagents and other products used in this standard are prepared in accordance with the requirements specified in GB/T 601 –2002, GB/T 60 –2002 and GB/T 603–2002.

5.3 Identification

5.3.1 Reagents and solution

5.3.1.1 Silver nitrate solution: 2 g/l;

5.3.1.2 Ammonia solution: 2+3;

5.3.1.3 Methyl orange solution: 1 g/l.

5.3.2 Identification method

5.3.2.1 Measure 1 ml of test sample, and put in 50 ml water. Dropwise add the silver nitrate solution to produces white precipitate. The precipitate is dissolved in ammonia solution, but not in nitric acid.

5.3.2.2 Measure 1 ml test sample and put it in 100 ml water. Add 2 drops of methyl orange solution, so the solution turns to red color. The solution possesses strong acidity.

5.3.3 Identification conclusion

The sample is hydrochloric acid when the above two tests present positive results.

5.4 Appearance

Visually observe the sample under natural light.

5.5 Determination of total acidity

5.5.1 Principle of the method

Test sample solution is titrated by sodium hydroxide standard solution, with bromcresol green solution as an indicator, to the end-point where the color of the solution from yellow turns to blue. The reaction formula as following:

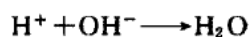

5.5.2 Reagents and solutions

5.5.2.1 Sodium hydroxide standard solution: $c(\text{NaOH}) = 1 \text{ mol/l}$;

5.5.2.2 Bromcresol green solution: 1 g/l.

5.5.3 Apparatus

General laboratory apparatus and the following containers:

5.5.3.1 Conical beaker, 100 ml (has ground stopper);

5.5.3.2 Titration tube, 50 ml, grade A with division of 0.1 ml.

5.5.4 Analysis procedure

5.5.4.1 Test sample solution

Measure about 3 ml of test sample and place into a conical beaker that is filled with 15 ml water and is weighed previously (precision to 0.0001 g). Mix well and weigh (precision to 0.0001 g).

5.5.4.2 Measurement

Add 2 – 3 drops of bromocresol green solution as an indicator into the test sample solution, and titrate by sodium hydroxide standard solution to the end-point where color of the solution turns from yellow to blue.

5.5.5 Calculation of the result

Total acidity is expressed as chlorine hydride (HCl), w_1 , the value is expressed as %, and calculated in accordance with the following formula (1):

$$w_1 = \frac{(V/1\ 000)cM}{m_1} \times 100 = \frac{VcM}{10m_1} \dots\dots\dots (1)$$

Where:

c – Accurate value of concentration of sodium hydroxide standard solution, the unit is mol/l;

V – Volumetric value of consumption of the sodium hydroxide standard solution used in titration of the test solution, the unit is ml;

m_1 – Mass of the test sample mass, the unit is g;

M – Mole mass of hydrochloric acid (HCl), the unit is g/mol ($M = 36.46$)

5.5.6 Allowable Deviation

The result is expressed as an average arithmetical value of replicate determinations. The difference between the absolute values of the results of the two parallel tests is not greater than 0.2%.

5.6 Determination of iron 1,10–Phenanthroline hydrate spectrophotometry

5.6.1 Principle of the method

Fe^{3+} in test sample is reduced to Fe^{2+} using hydroxylamine hydrochloride. Fe^{2+} reacts with 1,10–Phenanthroline hydrate to form a salmon pink complex in pH 4.5 of buffer solution, and absorbency is measured by spectrophotometer. The reaction formulas are as following:

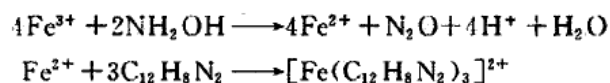

5.6.2 Reagents and solutions

5.6.2.1 Hydrochloric acid solution: 1+10;

5.6.2.2 Ammonia solution: 1+1;

5.6.2.3 Hydroxylamine hydrochloride solution: 100 g/l:

Weigh 10.0 g hydroxylamine hydrochloride, and dissolve it in water, then dilute to 100 ml with water.

5.6.2.4 Acetic acid and sodium acetate buffer solution: pH = 4.5.

5.6.2.5 Iron standard solution: 1 ml of the solution contains 0.1 mg iron (Fe).

Weigh 0.864 g of ferric ammonium sulfate $[\text{NH}_4\text{Fe}(\text{SO}_4)_2 \cdot 12\text{H}_2\text{O}]$ and dissolve in water. Add 10 ml sulfuric acid solution (25%), and transfer it into 1000 ml of volumetric flask, then dilute to the mark line.

5.6.2.6 Iron standard solution: 1 ml of the solution contains 0.01 mg iron (Fe).

Transfer 10 ml of the above iron standard solution by pipette into 100 ml of volumetric flask, and dilute to the mark with water. Shake well. This solution is prepared just before use.

5.6.2.7 1,10–Phenanthroline hydrate solution: 2 g/l.

This solution should avoid light during storage. Only use the colorless solution.

5.6.3 Apparatus

General laboratory apparatus and spectrophotometer.

5.6.4 Analysis procedure

5.6.4.1 Drawing of standard curve

5.6.4.1.1 Measure the Iron standard solution (Sec. 5.6.2.6) according to Table 2 below, and put it into 6 of 50 ml volumetric flasks, respectively.

Table 2

Volume of Iron Standard Solution/ml	Mass of Corresponding Iron/ μg
0	0

2.0	20
4.0	40
6.0	60
8.0	80
10.0	100

5.6.4.1.2 Add 10 ml hydrochloric acid solution into each of the volume flasks, and add water to about 20 ml. Adjust pH value to 2–3 using ammonia solution, and then add 1 ml hydroxylamine hydrochloride solution, 5 ml acetic acid–sodium acetate buffer and 2 ml 1,10–Phenanthroline hydrate solution one by one, dilute with water to the mark line. Shake well. Statically stay for 15 min.

5.6.4.1.3 Measure absorbency of the solution by using suitable cuvette at 510 nm of wave length, and using blank solution to adjust to 0 point of the spectrophotometer.

5.6.4.1.4 Set iron content (μg) as horizontal coordinate and the corresponding absorbency as vertical coordinate to draw up standard curve, or calculate the equation of linear regression.

5.6.4.2 Preparation of test sample solution

Measure 8.6 ml test sample, and weigh it with precision to 0.01 g, put into a 100 ml of volumetric flask that is filled 50 ml water previously, and then dilute to the mark with water. Shake well.

5.6.4.3 Test sample

Measure 10.0 ml test sample solution and put into a 50 ml of volumetric flask.

5.6.4.4 Blank test

Add 10.0 ml hydrochloric acid solution without adding the test sample, and conduct the blank test using the same procedures, same reagents and same amounts as the test sample.

5.6.4.5 Measurement

5.6.4.5.1 Add water in the test sample to about 20 ml, adjust pH value to about 2–3 using ammonia solution. Then add 1ml hydroxylamine hydrochloride solution, 5 ml acetic acid–sodium acetate buffer solution and 2 ml 1,10– Phenanthroline hydrate solution, and then dilute to the mark. Shake well. Statically stay for 15 min.

5.6.4.5.2 Measuring absorbency of the solution by using suitable cuvette at 510 nm of wave length, and using blank solution to adjust to 0 point of the spectrophotometer.

5.6.5 Calculation of the result

Iron content is expressed as mass fraction of iron (Fe) w_2 , the value is expressed as %, and calculated as formula (2):

$$w_2 = \frac{m_3 \times 10^{-6}}{m_2 \times 10/100} \times 100 = \frac{m_3 \times 10^{-3}}{m_2} \dots\dots\dots (2)$$

Where:

m_2 – Mass of the test sample, the unit is g;

m_3 – Mass of iron obtained from the standard curve, or calculated from the equation of linear regression, the unit is μg .

5.6.6 Allowable deviation

The result is expressed as an average arithmetical value of replicate determinations. The difference between the absolute values of results of the two parallel tests is not greater than 0.0001%.

5.7 Determination of sulfate

5.7.1 Principle of the method

Evaporate the test sample to dry, and dissolve the residue using hydrochloric acid solution. Add barium chloride, with glycerol-ethanol mixture as a stabilizer, to form suspension. Measure the absorbency of the suspension using spectrophotometer.

5.7.2 Reagents and solutions

5.7.2.1 Dihydrate barium chloride ($\text{BaCl}_2 \cdot 2\text{H}_2\text{O}$);

5.7.2.2 Glycerol-ethanol mixture: 1+2;

5.7.2.3 Hydrochloric acid solution: 1 mol/l;

5.7.2.4 Sulfate standard solution: 0.1 g/l.

There are two preparing methods, choose one of them.

- (1) Weigh 0.148 g anhydrous sodium sulfate that was dried to constant weight at (105–110) °C, dissolve in water, then transfer into a 1000 ml volumetric flask, and dilute to the mark.
- (2) Weigh 0.181 g of potassium sulfate that was dried to constant weight at (105–110) °C, dissolve in water, then transfer into a 1000 ml volumetric flask, and dilute to the mark.

5.7.3 Apparatus

General laboratory apparatus and spectrophotometer.

5.7.4 Analysis procedure

5.7.4.1 Drawing of standard curve

5.7.4.1.1 Measure the sulfate standard solution according to Table 3, and put it into 7 of 50 ml volumetric flasks, respectively.

Table 3

Sulfate Standard Solution/ml	Mass of Corresponding sulfate/ μg
0	0
2.5	0.25
5.0	0.50
7.5	0.75
10.0	1.00
15.0	1.50
20.0	2.00

5.7.4.1.2 Add 3 ml hydrochloric acid solution and 5 ml of glycerol-ethanol mixture into each of the volumetric flasks, respectively, and dilute with water to the mark line. Shake well.

5.7.4.1.3 Transfer the solution in the volumetric flasks into dry beaker that contains 0.3 g dihydrate barium chloride. Shake it at 2 revolutions per second for 2 min, and then statically stay for 10 min at room temperature.

5.7.4.1.4 Measure the absorbency of the solution by using suitable cuvette at 450 nm of wave length, and using blank solution to adjust to 0 point of the spectrophotometer.

5.7.4.1.5 Set sulfate content (mg) as horizontal coordinate and the corresponding absorbency as vertical coordinate to draw up standard curve, or calculate the equation of linear regression.

5.7.4.2 Test sample

Weigh 20 g sample (precision to 0.01 g), put into evaporating dish, and evaporate it to dry on vapor bath. Cool down to room temperature. Add 3 ml hydrochloric acid solution to dissolve the residue, and transfer to a 50 ml volumetric flask, and then add 5 ml of glycerol-ethanol mixture and dilute to the mark with water. Shake well.

5.7.4.3 Blank test

Without adding the test sample, and conduct the blank test using the same procedure, same reagents and same amounts as the test sample.

5.7.4.4 Measurement

5.7.4.4.1 Carefully transfer the test sample into a dry beaker that contains 0.3 g dihydrate barium chloride, and shake it at 2 revolutions per second for 2 min. Statically stay for 10 min at room temperature.

5.7.4.4.2 Measure absorbency of the solution by using suitable cuvette at 450 nm of wave length, and using blank solution to adjust to 0 point of the spectrophotometer.

5.7.5 Calculation of the result

Sulfate content is expressed as mass fraction of sulfate radical (SO_4^{2-}) w_3 , the value is expressed as %, and calculated as formula (3):

$$w_3 = \frac{m_5 \times 10^{-3}}{m_4} \times 100 = \frac{m_5}{10m_4} \dots\dots\dots (3)$$

Where:

m_4 – Mass of the sample, the unit is g;

m_5 – Mass of sulfate obtained from the standard curve, or calculated from the equation of linear regression, the unit is mg.

5.7.6 Allowable deviation

The result is expressed as an average arithmetical value of replicate determinations. The difference between the absolute values of results of the two parallel tests is not greater than 0.001%.

5.8 Determination of free chlorine

5.8.1 Principle of the method

Add the potassium iodide solution into the test sample solution, and iodine is separated out. Iodine is then titrated using sodium thiosulfate standard solution with starch solution as indicator. Reaction is as follow:

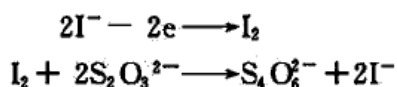

5.8.2 Reagents and solutions

5.8.2.1 Hydrochloric acid

Oxide or reducing matter contained in hydrochloric acid is less than 0.0002%.

5.8.2.2 Potassium iodide solution: 150 g/l.

Weigh 15.0 g potassium iodide, dissolve in water and dilute to 100 ml with water.

5.8.2.3 Sodium thiosulfate standard solution: $c(\text{Na}_2\text{S}_2\text{O}_3) = 0.1 \text{ mol/l}$.

5.8.2.4 Starch indication solution: 10 g/l.

This solution is only preserved for 2 weeks.

5.8.3 Apparatus

General laboratory apparatus and following apparatus:

5.8.3.1 Conical beaker, 500 ml (with ground stopper);

5.8.3.2 Microburette.

5.8.4 Analysis procedure

5.8.4.1 Test sample

Measure 50 ml of test sample and put into a conical beaker that contains 100 ml water, and was weighed previously (accuracy of 0.01 g). Cool down to room temperature, and weigh (precision to 0.01 g).

5.8.4.2 Blank test

Without adding the test sample, use hydrochloric acid to replace test sample, and then conduct the blank test using the same procedure, same reagents and same amounts as the test sample.

5.8.4.3 Measurement

Add 7 ml of potassium iodide solution into the test sample. Close cork and shake. Add 1 ml of starch indication solution, and then titrate the solution with sodium thiosulfate standard solution to the end-point where blue color is vanished.

5.8.5 Calculation of the result

Free chlorine is expressed as mass fraction of chlorine (Cl), w_4 , the value is expressed as %, and calculated in accordance with formula (4):

$$w_4 = \frac{[(V_1 - V_0)/1\ 000]cM}{m_6} \times 100 = \frac{(V_1 - V_0)cM}{10m_6} \dots\dots\dots (4)$$

Where:

c – Accurate value of concentration of the sodium thiosulfate standard solution, the unit is mol/l;

V_0 – Volumetric value of consumption of the sodium thiosulfate standard solution used in titration of the blank solution, the unit is ml;

V_1 – Volumetric value of consumption of the sodium thiosulfate standard solution used in titration of the test solution, the unit is ml;

m_6 – Mass of the test sample, the unit is g;

M – Mole mass of chlorine (Cl), the unit is g/mol ($M = 35.45$).

5.8.6 Allowable deviation

The result is expressed as an average arithmetical value of replicate determinations. The difference between the absolute values of results of the two parallel tests is not greater than 0.001%.

5.9 Determination of reducing matter

5.9.1 Principle of the method

In acidic condition, iodine reacts with starch indication solution to present blue color. Iodine is reduced when reacts with reducing matter, blue color of the solution will turn to tint or vanished.

5.9.2 Reagents and solutions

5.9.2.1 Hydrochloric acid;

5.9.2.2 Potassium of iodide: 10 g/l;

5.9.2.3 Iodine standard solution: $c(1/2I_2) = 0.001$ mol/l.

Measure 1 ml iodine standard solution prepared according to GB/T 601-2002, and put into a 100 ml volumetric flaks, and dilute to the mark. Shake well. This solution is prepared just before use.

5.9.2.4 Starch indication solution: 10 g/l.

5.9.3 Apparatus

General laboratory apparatus.

5.9.4 Measurement

Measure 1 ml of hydrochloric acid (5.9.2.1.) and put into 30 ml test tube, and dilute to 20 ml with water that was just boiled and cooled down. Then add 1 ml potassium iodide solution, 1 ml starch solution and 2.0 ml of iodine standard solution one by one. Shake well. Add 1 ml test sample into the test tube, blue color of the solution is not vanished.

5.10 Determination of non-volatile matter

5.10.1 Principle of the method

A certain amount of sample is evaporated to dry and is weighed to constant weight.

5.10.2 Apparatus

General laboratory apparatus.

5.10.3 Analysis procedure

Weigh 5 g of test sample (precision to 0.01 g) and put into an evaporating dish that was weighed previously (precision to 0.0001 g). Evaporate the test sample on vapor bath to dry, and then heat it at 110 °C for 1 hour. Put it into a desiccators to cool down to room temperature and weigh (precision to 0.0001 g).

5.10.4 Calculation of the result

Non-volatile matter is expressed as mass fraction, w_5 , its value is as %, and calculated in accordance with formula (5):

$$w_5 = \frac{m_8}{m_7} \times 100 \quad \dots\dots\dots (5)$$

Where:

m_7 – Mass of the test sample, the unit is g;

m_8 – Mass of non-volatile matter, the unit is g.

5.10.5 Allowable deviation

The result is expressed as an average arithmetical value of replicate determinations. The difference between the absolute values of results of the two parallel tests is not greater than 0.005%.

5.11 Determination of arsenic

5.11.1 Determination of arsenic Silver diethyldithiocarbamate spectrophotometer (Arbitration method)

5.11.1.1 Principle of the method

In acidic condition, As^{5+} can be reduced to As^{3+} by potassium iodide and stannous chloride. Zinc granule reacts with acid to produce nascent hydrogen, which further reduces As^{3+} to hydrogen arsenide. Hydrogen arsenide is absorbed by silver diethyldithiocarbamate [$\text{Ag}(\text{DDTC})$]-pyridine solution to form fuchsia colloidal solution of which absorbency is measured using spectrophotometer. The reaction formula is as follows:

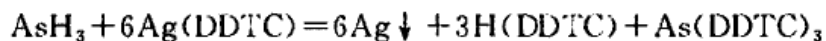

5.11.1.2 Reagents and materials

All reagents do not contain arsenic.

5.11.1.2.1 Hydrochloric acid;

5.11.1.2.2 Arsenic trioxide.

Danger – Arsenic trioxide has hypertoxicity.

5.11.1.2.3 Zinc granule: granule diameter (0.5 – 1) mm.

5.11.1.2.4 Potassium iodide solution: 150 g/l.

Weigh 15.0 g of potassium iodide and dissolve in water, and dilute to 100 ml with water.

5.11.1.2.5 Stannous chloride hydrochloric acid solution: 400 g/l.

Weigh 40.0 g of dihydrate stannous chloride ($\text{SnCl}_2 \cdot 2\text{H}_2\text{O}$) and dissolve in the mixed solution that consists of 25 ml of water and 75 ml of hydrochloric acid.

5.11.1.2.6 Arsenic standard solution: 1 ml solution contains arsenic (As) 0.1 mg.

Weigh 0.132 g of arsenic trioxide that was previous dried to constant weight in sulfuric acid desiccators, and dissolve in 1.2 ml of warm sodium hydroxide solution (100 g/l), and then transfer into a 1000 ml volumetric flask, and dilute to the mark.

5.11.1.2.7 Arsenic standard solution: 1 ml solution contains 2.5 mg of arsenic (As).

Transfer 25 ml of the above arsenic standard solution by pipette into a 1000 ml of volumetric flask, and dilute to the mark with water. Shake well. The solution is prepared just before use.

5.11.1.2.8 Silver diethyldithiocarbamate pyridine solution: 5 g/l:

Weigh 1.0 g of silver diethyldithiocarbamate, and dissolve in pyridine, and dilute to 200 ml with pyridine. This solution is stored in a closed brown glass bottle. Its shelf-life is 2 weeks.

5.11.1.2.9 Lead acetate cotton.

5.11.1.3 Apparatus

All glass apparatus should be carefully cleaned using hot concentrated sulfuric acid, then washed using water, and dried.

General laboratory apparatus and the following apparatus:

5.11.1.3.1 Apparatus for determining arsenic (see Fig.1).

5.11.1.3.2 Spectrophotometer.

5.11.1.4 Analysis procedure

Warning – Some of reagents used in this test have toxicity. Conduct the test in chemical hood.

5.11.1.4.1 Drawing of standard curve

Redraw the standard curve whenever zinc granule is changed or the silver diethyldithiocarbamate pyridine solution is newly prepared.

Unit: mm

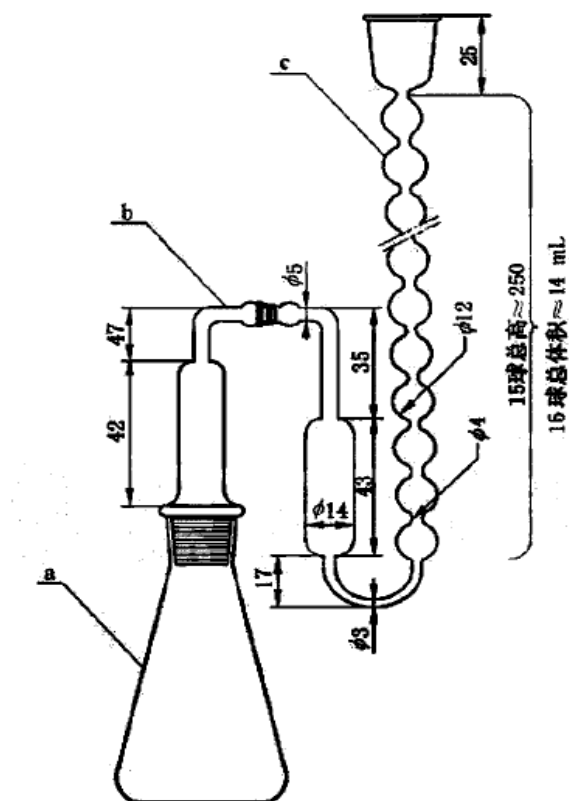

a – 100 ml conical beaker

b – Connection tube

c – 15 Sphere absorbing tube

Fig. 1 Apparatus for Determining Arsenic

5.11.1.4.1.1 Measure the arsenic standard solution (5.11.1.2.7), and put into 6 of 100 ml of volumetric flasks, respectively (Fig. 1), according to table 4 below.

Table 4

Volume of Iron Standard Solution/ml	Mass of Corresponding Iron/ μg
0.0	0
1.0	2.5
2.0	5
4.0	10
6.0	15
8.0	20

5.11.1.4.1.2 Add 10 ml of hydrochloric acid into each of the volumetric flasks, and add water to 40 ml, respectively.

5.11.1.4.1.3 Measure 5 ml the silver diethyldithiocarbamate pyridine solution, and put into c in Fig. 1, and then connect c and b that was filled with lead acetate cotton previously in Fig.1.

5.11.1.4.1.4 Add 2 ml potassium iodide solution and 2 ml stannous chloride solution into each of the volumetric flasks sequentially, shake well and statically stay for 15 min. Then add 5 g of zinc granule, and according to Fig 1, connect the apparatus rapidly to react for 45 min.

5.11.1.4.1.5 Measure absorbency of the solution by using suitable cuvette at 540 nm of wave length, and using blank solution to adjust to 0 point of the spectrophotometer.

5.11.1.4.1.6 Set arsenic content (μg) as horizontal coordinate and the corresponding absorbency as vertical coordinate to draw up standard curve, or calculate the equation of linear regression.

5.11.1.4.2 Test sample

Weigh 10.0 ml of test sample (precision to 0.01 g) (increase the sampling size if arsenic content is too low, and then evaporate to about 10 ml using heat), and transfer into a in Fig. 1, add water to about 40 ml.

5.11.1.4.3 Blank test

Add 10.0 ml hydrochloric acid without adding the test sample, and add water to about 40 ml. Conduct the blank test using the same analytical procedure, same reagents and same amount as the test sample.

5.11.1.4.4 Measurement

Measurement is conducted according to Sec. 5.11.1.4.1.3 – 5.11.1.4.1.5.

5.11.1.5 Calculation of the result

Arsenic is expressed as mass fraction of arsenic (As), w_6 , the value is expressed as %, and calculated in accordance with formula (6):

$$w_6 = \frac{m_{10} \times 10^{-6}}{m_9} \times 100 \quad \dots\dots\dots (6)$$

Where:

m_9 – Mass of the sample, the unit is g;

m_{10} – Mass of arsenic in sample obtained from the standard curve, or calculated from the equation of linear regression, the unit is μg .

5.11.1.6 Allowable deviation

The result is expressed as an average arithmetical value of replicate determinations. The difference between the absolute values of results of the two parallel tests is not greater than 0.00005%.

5.11.2 Determination of arsenic Arsenic Stain Method

5.11.2.1 Principle of the method

In acidic condition, As^{5+} can be reduced to As^{3+} by potassium and stannous chloride. Zinc granule reacts with acid to produce nascent hydrogen, which further reduces As^{3+} to hydrogen arsenide. Hydrogen arsenide gas reacts with mercury bromide test paper to form mercury and arsenic compound with pale brown color, and then compared with the standard color.

5.11.2.2 Reagents and materials

All reagents do not contain arsenic.

5.11.2.2.1 Hydrochloric acid;

5.11.2.2.2 Zinc granule: Granule diameter (0.5 – 1) mm;

5.11.2.2.3 Potassium iodide solution: 150 g/l;

Weigh 15.0 g potassium iodide and dissolve in water, and dilute to 100 ml by water.

5.11.2.2.4 Stannous chloride hydrochloric acid solution: 400 g/l;

Weigh 40.0 g dihydrate stannous chloride ($\text{SnCl}_2 \cdot 2\text{H}_2\text{O}$), and dissolve in the mixed solution of 25 ml of water and 75 ml of hydrochloric acid (5.8.2.2.1). If the solution turns to turbid, it can be heated to transparent state.

5.11.2.2.5 Arsenic standard solution: 1 ml solution contains 1mg of arsenic (As).

Transfer 10 ml of the arsenic standard solution (5.11.1.2.6) by pipette into a 1000 ml volumetric flask, dilute to the mark with water. Shake well. The solution is prepared just before use.

5.11.2.2.6 Lead acetate cotton;

5.11.2.2.7 Mercury bromide test paper.

5.11.2.3 Apparatus

General laboratory apparatus and apparatus of determining arsenic (see Fig. 2).

5.11.2.4 Analysis procedure

5.11.2.4.1 Test sample

Weigh about 2 g sample (precision to 0.01 g), and transfer into a 100 ml conical beaker.

5.11.2.4.2 Measurement

Add 23 ml water, 4 ml hydrochloric acid (5.11.2.2.1), 5 ml potassium iodide solution and 5 drops stannous chloride solution into the test sample sequentially. Statically stay at room temperature for 10 min. Then add 2 g of zinc granule, and according to Fig. 2, rapidly connect the tubes that were filled with lead acetate cotton and mercury bromide test paper previously, and is stored in dark place at room temperature for (1 – 2) h.

Unit: mm

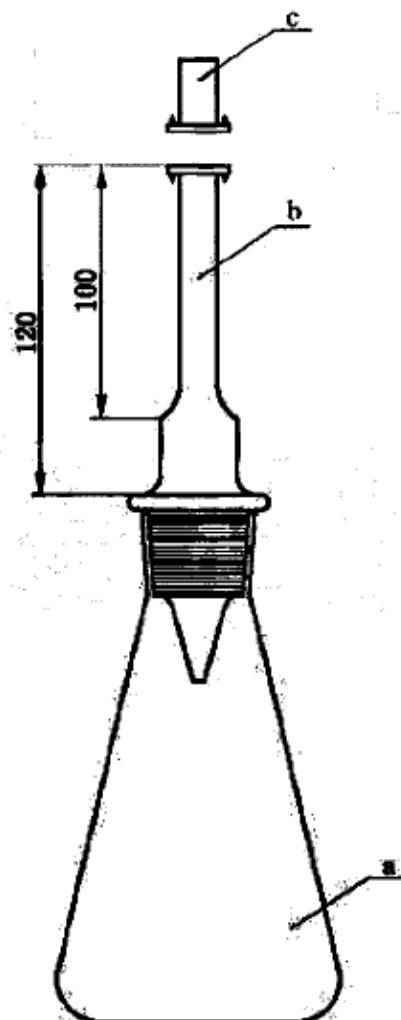

a – 100 ml conical beaker;

b – Absorbing tube;

c – Cap of Absorbing tube

Fig. 2 Apparatus for Determining Arsenic

If the color of mercury bromide test paper presents lighter or equal color compared with the standard color, the result is qualified, the color is deeper than one of standard is unqualified.

5.11.2.4.3 Preparation of standard color

Prepare the standard color when conduct each of tests.

Add 2 g of hydrochloric acid (5.11.2.2.1)(accuracy of 0.01 g) and 2.0 ml of arsenic standard solution into a 100 ml conical beaker, and then conduct the following procedure specified in Sec. 5.11.2.4.2.

5.12 Determination of heavy metal

5.12.1 Principle of the method

In weak acidic condition (pH 3 – 4), heavy metal ion in test sample reacts with hydrogen sulfide to produce brownish-black compound, it is compared with the color of lead standard solution conducted under the same procedure for limiting test.

5.12.2 Reagents and solutions

5.12.2.1 Ammonia solution;

5.12.2.2 Acetate buffer solution: pH = 3.5;

Weigh 25.0 g ammonium acetate and dissolve in 25 ml of water, and then add 45 ml hydrochloric acid (6 mol/l), adjust pH to 3.5 using dilute hydrochloric acid or ammonia solution, and dilute to 100 ml with water.

5.12.2.3 Lead standard solution: 1 ml solution contains 1.0 mg of lead (Pb);

Weigh 0.1598 g of high purity lead nitrate and dissolve in 10 ml 1% nitric acid. Quantitatively transfer into a 100 ml volumetric flask, and then dilute to the mark with water. Shake well.

5.12.2.4 Lead standard solution: 1 ml solution contains 0.01 mg of lead (Pb):

Transfer 10 ml of the above lead standard solution with pipette into a 1000 ml of volumetric flask, and dilute with water to the mark. Shake well. This solution is prepared just before use.

5.12.2.5 Saturated hydrogen sulfide solution

Hydrogen sulfide gas passes through water that does not contain carbon dioxide until saturation is reached. This solution is prepared just before use.

5.12.2.6 Phenolphthalein solution: 10 g/l.

5.12.3 Apparatus

General laboratory apparatus and 50 ml of Nessler tube.

All glass apparatus is marinated in 10 – 20% nitric acid (mass fraction) for 24 h or longer and washed using water repeatedly and finally washed using distilled water.

5.12.4 Measurement

5.12.4.1 Tube A: Measure 5.0 ml lead standard solution (not less than 10 µg of lead) and put into a 50 ml of Nessler tube, and add water to 25 ml, mix well, add 1 drop of phenolphthalein solution, adjust pH value to neutral using ammonia solution (red color of phenolphthalein is just vanished). Add 5 ml of acetate buffer solution (pH 3.5), and mix well for future use.

5.12.4.2 Tube B: Measure 10 ml test sample and put into the Nessler tube that matches with tube A, add water to 25 ml, and mixing well. Add 1 drop of phenolphthalein solution and adjust pH to neutral (red color of phenolphthalein is just vanished) using ammonia solution. Add 5 ml acetate buffer solution (pH 3.5), and mix well for future use.

5.12.4.3 Tube C: In a Nessler tube that matches with tube A and tube B, add the same amount of test sample as tube B, and add the same amount of lead standard solution, and add water to 25 ml. Mix well. Add 1 drop of phenolphthalein solution and adjust pH to neutral with ammonia solution (red color of phenolphthalein is just vanished), and then add 5 ml acetate buffer solution (pH 3.5). Mix well for future use.

5.12.4.4 Add 10 ml of newly prepared saturated hydrogen sulfide solution to each of the tubes, and add water to 50 ml. Mixing well and place in dark place for 5 min. The color in tube B cannot be deeper than the one in tube A, the color in tube C is equal to or deeper than the one in tube A.

6 Inspection Rules

6.1 All items in this standard are type test, among them, total acidity, iron, free chlorine, arsenic and heavy metal are delivery tests, and must be inspected every batch. The rest of them are random inspected in following cases: reproduction after the production downtime, processing technique has significant change (*e.g.* materials and processing conditions), requirements of contract, etc. In normal case, conducting type tests at least once a month.

6.2 Products inspected by batch. A batch is defined as a tank of final product or food additive of hydrochloric acid product that produced in one day.

6.3 Using acid-resistance sampler specified in GB/T 6680 – 2003 to sample the same amount of hydrochloric acid from top, middle and bottom of tank or storage tank (top layer is 1/10 to the surface, bottom layer is 1/10 to the bottom).

6.4 When sampling food additive of hydrochloric acid from polyethylene barrel, or fiberglass lined container, or special porcelain jar, using acid-resistance sampler specified in GB/T 6680 – 2003 to sample and sampling number follows requirements of GB/T 6678 – 2002.

6.5 The samples are mixed well and packed in a clean, dry plastic bottle or in glass bottle with ground stopper, and the bottle is closed. The amount of sample is not less than 500 ml. Labeling the sample bottle with manufacturer name, product name, batch No. or production date, sampling date and name of sample collector, etc.

6.6 The tests for food additive of hydrochloric acid must be conducted by department of quality supervision and inspection in accordance to this standard. Manufacturer must ensure product of each batch delivered is complied with the requirements specified in this standard.

6.7 If testing results are not complied with the requirements in this standard, sampling must be conducted again from 2 fold amount of packaged product. Even if only one item is not complied with the requirement in this standard, the entire batch is considered as disqualified.

7 Marking and Labeling

7.1 On the packaging container of food additive of hydrochloric acid, labeling must be firm and clear, including manufacturer name, manufacturing address, product name, “food additive” typeface, range of use, maximum use amount, net content, batch number or production date, shelf-life, hygiene permit number, production permit number and mark, and this standard number, as well as “causticity” mark and safety label specified in GB 190-1990. For small amount of package, the package should also have “up” marks specified in GB/T 191-2008. The range of use and maximum amount of use are followed GB 2760 – 1996.

7.2 Food additive of hydrochloric acid for each batch delivered must attach statement of safety, and certificate of quality that includes manufacturer name, manufacturing address, product name, hazardous chemical, “food additive” typeface, range of use, maximum amount of use, net content, batch No. or production date, shelf-life, hygiene permit No., production permit No., as well as mark, certificate of quality of the product that comply with this standard, and this standard No.

8 Packaging, Transport and Storage

8.1 Food additive of hydrochloric acid is packaged and shipped using special tank wagon or storage tank, and the containers must be cleaned periodically. Polyethylene barrel, fiberglass lined container or special porcelain jar must be complied to requirements of food packaging.

8.2 It is inhibited that the product is transported and stored mixed-up with alkaline or toxic and hazardous materials during transportation.

8.3 Food additive of hydrochloric acid is stored in specially assigned tank or warehouse. It is inhibited that the product is stored mixed-up with alkali, or toxic, and hazardous materials during storage..

8.4 Shelf-life of food additive of hydrochloric acid is 24 months in the conditions that are complied with requirements of package, transportation and storage. It can continue to use if it possesses acceptance certificate after expiration of the shelf-life.

Appendix L

GB 5175–2008

Food Additive – Sodium Hydroxide

ICS 67.220.20
X 42



National Standard of the People's Republic of China

GB 5175–2008
Replace GB 5175–2000

Food Additive – Sodium Hydroxide

Issued on: June 25, 2008

Implemented on: January 1, 2009

Issued by: **General Administration of Quality Supervision, Inspection and Quarantine of the People's Republic of China; and Standardization Administration of the People's Republic of China**

Foreword

In this standard, the Chapter 4, 7 and 9 are mandatory, the rest of them are recommendatory.

This standard is not equivalent to *Sodium Hydroxide* specified in US Food and Chemical Codex [FCC (V): 2004] in terms of consistency.

This standard replaces GB 5175-2000 *Food Additive – Sodium Hydroxide*.

The major differences between this standard and previous GB 5175-2000 are as following:

- Add “Appearance” in “Requirements” (Sec. 4.1 in this standard);
- Revise the total alkali quantity of food additive of solid sodium hydroxide from “95.0% – 100.5%” to “98.0% – 100.5%” (Chapter 3 in 2000 Edition; Sec. 4.2 in this Edition);
- Revise the total alkali content of food additive of liquid sodium hydroxide from “97.0% – 103.0%” to “98.0% – 103.0%” (Chapter 3 in 2000 Edition; Sec. 4.3 in this Edition);
- Revise the sodium carbonate content in food additive of both solid and liquid sodium hydroxide from “not more than 3.0%” to “2.0%” (Chapter 3 in 2000 Edition; Sec. 4.2 and 4.3 in this Edition);
- Revise the heavy metal content in food additive of both solid and liquid sodium hydroxide from “0.002%” to “0.0005%” (Chapter 3 in 2000 Edition; Sec. 4.2 in this Edition);
- Withdraw the requirement of lead (Pb) content in food additive of both solid and liquid sodium hydroxide (Chapter 3 in 2000 Edition; Sec. 4.2 and 4.3 in this Edition);
- Revise the mercury content in food additive of liquid sodium hydroxide from “0.0001%” to “0.00001%” (Chapter 3 in 2000 Edition; Sec. 4.3 in this Edition);
- Revise the indicator from “methyl orange indicator” to “bromocresol green-methyl red mixed indicator” in total alkali content test, (Sec. 4.2 in 2000 Edition; Sec. 5.5 in this Edition).

This standard was proposed by China Petroleum and Chemical Industry Association (CPCIA).

This standard is under the jurisdictions both of Subcommittee of Inorganic Chemical Industry, National Technical Committee 63 on Chemical of Standardization Administration of China (SAC/TC 63/SC1) and of National Technical Committee 11 on Food Additives of Standardization Administration of China (SAC/TC 11).

The principal drafting organization of this standard: Qingdao Hygain Chemical (Group) Co., Ltd., Sichuan Honghe Chemical Industry (Group) Co., Ltd., and Tianjin Chemical Research and Design Institute.

The principal drafters of this standard: Yingmin Zhang; Yong Cao; and Yan Wang.

The previous Editions replaced by this standard:

— GB 5175-1985 and GB 5175-2000.

Food Additive – Sodium Hydroxide

1 Scope

This standard specifies the requirements, test method, inspection rule, marking, labeling, packaging, transport and storage for food additive of sodium hydroxide.

This standard is applicable to food additive of sodium hydroxide that is used as acidity regulator and processing aid in food industry.

2 Normative Reference Standards

The following standards contain provisions which, through reference in this text, constitute provisions of this standard. For the dated references, subsequent amendments to (error corrections not included) or revisions of, any of these publications will be not applicable to this standard. However, the parties to agreements based on this standard are encouraged to investigate the possibility of applying the most recent editions of the standards. For undated references, the latest edition of the normative document referred to applies.

GB 190–1990 Labels for Packages of Hazardous Goods

GB/T 191–2008 Packaging—Pictorial Marking for Handling of Goods (ISO 780:1997, MOD)

GB/T 534–2002 Commercial Sulfuric Acid

GB/T 6678 General Principles for Sampling Chemical Products

GB/T 6682–2008 Water for Analytical Laboratory Use – Specification and Test Methods (ISO 3696:1987, MOD)

GB/T 5009.74–2003 Method for Limit Test of Heavy Metals in Food Additives

GB/T 5009.76–2003 Determination of Arsenic in Food Additives

HG/T 3696.1 Inorganic Chemical Products: Preparations of Standard Volumetric Solutions for Chemical Analysis

HG/T 3696.2 Inorganic Chemical Products: Preparations of Standard Solutions for Chemical Analysis

HG/T 3696.3 Inorganic Chemical Products: Preparations of Standard and Reagent Solutions for Chemical Analysis

3 Molecular Formula and Relative Molecular Mass

Molecular formula: NaOH

Relative molecular mass: 40.00 (based on International Relative Atomic Mass 2007)

4 Requirements

4.1 Appearance

4.1.1 Food additive of solid sodium hydroxide is white or off-white.

4.1.2 Food additive of liquid sodium hydroxide is clear or slightly turbid, colorless or pink color liquid.

4.2 Food additive of solid sodium hydroxide must comply with the requirements in Table 1.

Table 1 Requirements

Item	Index
Total alkali content (as NaOH), w %	98.0 – 100.5
Sodium carbonate (Na ₂ CO ₃), w %	≤ 2.0
Arsenic (As), w %	≤ 0.0003
Heavy metals (as Pb), w %	≤ 0.0005
Insoluble and organic impurity	Pass test
Mercury (Hg), w %	≤ 0.00001

4.3 Food additive of liquid sodium hydroxide must comply with the requirements in Table 2.

Table 2 Requirements

Item	Index
Total alkali content (as NaOH) (calculated by indication value of sodium hydroxide), w %	98.0 – 103.5
Sodium carbonate (Na ₂ CO ₃) (calculated by indication value of sodium hydroxide), w %	≤ 2.0
Arsenic (As), w %	≤ 0.0003
Heavy metals (as Pb), w %	≤ 0.0005
Insoluble and organic impurity	Pass test
Mercury (Hg), w %	≤ 0.00001

5 Test Methods

5.1 Safety warning

Same as the strong acid used in the test, this product is a strong alkali with causticity, therefore one must be cautious when handle the product. If by any chance the product spill to skin, must rinse out immediately using large amount of water.

5.2 General specifications

Unless otherwise noted, all reagents and water used in this standard are analytical reagents and third grade of water specified in GB/T 6682–2008.

Unless otherwise noted, all standard solutions, impurity standard solutions, preparations of reagents and other products are prepared in accordance with the requirements specified in HG/T 3696.1, HG/T 3696.2 and HG/T 3696.3.

5.3 Appearance identification

Visually identify the sample under natural light.

5.4 Identification test

5.4.1 Aqueous solution of this product can dissociate ion of OH^- , and present strong alkaline property.

5.4.2 Identification of sodium ion

5.4.2.1 Apparatus and equipment

Glass rod with platinum filament fused on the top end of the rod.

5.4.2.2 Operation procedure

Soak the clean platinum filament with hydrochloric acid, and burn to colorless using flame, and then dip the sample and burn over the colorless flame; the flame presents bright yellow color.

5.5 Determinations of total alkali and sodium carbonate

5.5.1 Abstract of the method

Total alkali content: The sample solution is titrated using hydrochloric acid standard solution with bromocresol green-methyl red as an indicator to the end-point. The total alkali content is determined based on consumption of the hydrochloric acid standard solution.

Sodium carbonate content: Add barium chloride into the sample solution, and then sodium carbonate is transformed to precipitate of barium carbonate. Sodium hydroxide presented in the

solution is titrated to the end-point using hydrochloric acid standard solution, with phenolphthalein as an indicator, to determine the sodium hydroxide content. Sodium carbonate content is obtained by subtracting sodium hydroxide content from total alkali content.

5.5.2 Reagents and materials

5.5.2.1 Barium chloride solution: 100 g/l;

Adjust the solution to pink color using sodium hydroxide solution with phenolphthalein as indicator prior to use.

5.5.2.2 Hydrochloric acid standard solution: c (HCl) is about 1 mol/l;

5.5.2.3 Phenolphthalein indicator solution: 10 g/l;

5.5.2.4 Bromocresol green-methyl red indicator solution: 1 g/l.

5.5.3 Analysis procedure

5.5.3.1 Preparation of the test solution

Rapidly weigh solid sodium hydroxide (38 ± 1) g or liquid sodium hydroxide (50 ± 1) g using weighing bottle with known mass, with precision to 0.01 g, and put into 400 ml polyethylene bottle and dissolve in water. Cool to room temperature and transfer to a 1000 ml volumetric flask with plastic plug, dilute to the scale mark with water. Shake well. Place the solution into clean and dry polyethylene bottle. This is the test solution A.

5.5.3.2 Measurement

Transfer 50 ml test solution A into a 250 ml conical beaker using pipette, and then add 2 to 3 drops of bromocresol green-methyl red solution. Under stirring condition with magnetic stirring apparatus, the test solution is titrated from green to dark red color using hydrochloric acid standard solution in closed manner. Boil for 2 min, cool down and continually titrate to dark red color again.

Transfer 50 ml test solution A into a 250 ml conical beaker using pipette, add 20 ml of barium chloride solution, and then add 2 to 3 drops of phenolphthalene solution. Under stirring condition with magnetic stirring apparatus, the test solution is titrated by hydrochloric acid standard solution in closed manner to end-point with pink color.

5.5.4 Calculations of the results

5.5.4.1 Total alkali content is expressed as mass fraction of sodium hydroxide (NaOH), w_1 , the value is expressed as %, and is calculated in accordance with formula (1):

$$w_1 = \frac{V_1 c M_1 / 1\,000}{m \times \frac{50}{1\,000}} \times 100 \quad \dots\dots\dots (1)$$

5.5.4.2 Sodium carbonate content is expressed as mass fraction of sodium carbonate (Na_2CO_3) w_2 , its value is expressed as %, and is calculated using formula (2):

$$w_2 = \frac{(V_1 - V_2) c M_2 / 1\,000}{m \times \frac{50}{1\,000}} \times 100 \quad \dots\dots\dots (2)$$

Where:

V_1 – Volume value of consumption of the sodium hydroxide standard solution during the titration of the test solution with bromocresol green-methyl red as indicator. The unit is expressed as milliliter (ml);

V_2 – Volume value of consumption of the sodium hydroxide standard solution during the titration of the test solution with phenolphthalene solution as indicator. The unit is expressed as milliliter (ml);

c – Accurate value of concentration of the sodium hydroxide standard solution, the unit is expressed as mole per liter (mol/l);

m – Mass of the test material, the unit is gram (g);

M_1 – Value of mole mass of sodium hydroxide (NaOH), the unit is expressed as gram per mole (g/mol) ($M = 40.00$)

M_2 – Value of mole mass of sodium carbonate ($1/2 \text{Na}_2\text{CO}_3$), the unit is gram per mole (g/mol) ($M = 52.99$)

5.5.4.3 Mass fraction of total alkali content (as NaOH) in liquid sodium hydroxide, which is expressed as the mass fraction of the mark value of concentration of liquid sodium hydroxide, w_3 , the value is expressed as %, and is calculated in accordance with formula (3):

$$w_3 = \frac{w_1}{b} \times 100 \quad \dots\dots\dots (3)$$

5.5.4.4 Mass fraction of sodium carbonate content (as Na_2CO_3) in liquid sodium hydroxide, which is expressed as the mass fraction of the mark value of concentration of sodium carbonate in liquid sodium hydroxide, w_4 , the value is expressed as %, and is calculated in accordance with formula (4):

$$w_4 = \frac{w_2}{b} \times 100 \quad \dots\dots\dots (4)$$

Where:

b – Mark value of concentration of liquid sodium hydroxide.

Measurement result is expressed as an average arithmetical value of replicate determinations. The difference between the absolute values of mass fraction of sodium hydroxide of the two parallel tests is not greater than 0.2%; the difference between the absolute values of mass fraction of sodium carbonate of the two parallel tests is not greater than 0.1%.

5.6 Determination of arsenic

Weigh (10.00±0.01) g solid sodium hydroxide sample or liquid sodium hydroxide that is equivalent to (10.00±0.01) g (converted based on actual measurement of mass fraction of liquid sodium hydroxide) solid sodium hydroxide, add 20 ml water to dissolve or dilute. Slowly add hydrochloric acid solution (1+1) to neutralize to neutral (using pH test paper as indicator). After cooling down to room temperature, transfer into a 100 ml volumetric flask, and dilute to the mark. Shake well (if necessary using dry filtration, and discarding the primary filtrate). This is the test solution B, and reserve for future use.

Transfer 10 ml test solution B by pipette into arsenic bottle, and determine arsenic content according to arsenic stain method specified in GB/T 5009.76–2003.

Transfer 3 ml arsenic standard solution (1 ml standard solution contains 1 μg arsenic) using pipette as standard, and determine arsenic content according to the arsenic stain method specified in GB/T 5009.76–2003.

5.7 Determination of heavy metal

Transfer 20 ml test solution B into 50 ml colorimeter tube by pipette, and add 1 drop of phenolphthaleine solution as indicator, and adjust to pink color using ammonia aqueous solution (1+1), and then conduct the test according to Chapter 6 in GB/T 5009.74–2003.

Transfer 10 ml lead standard solution (1 ml solution contains 1 μg lead) as a standard by pipette, and conduct the test according to Chapter 6 in GB/T 5009.74–2003.

5.8 Determinations of insoluble and organic impurity

Weigh (5.00±0.01) g solid sodium hydroxide, and dissolve in 100 ml water. This solution is completely clear, colorless or slight color.

5.9 Determination of mercury

5.9.1 Abstract of the method

Same as Sec. 5.6.2.1 in GB/T 534–2002.

5.9.2 Reagents

5.9.2.1 Sulfuric acid solution: 1+1; other reagents are same as Sec. 5.6.2.2 in GB/T 534–2002.

5.9.3 Apparatus and equipment

Same as Sec. 5.6.2.3 in GB/T 534–2002.

5.9.4 Analysis procedure

5.9.4.1 Preparation of the test solution

Weigh (2.00 ± 0.01) g solid sodium hydroxide or liquid sodium hydroxide that is equivalent to (2.00 ± 0.01) g solid sodium hydroxide, and put into a 100 ml beaker, and dissolve in 20 ml water. Add 10 ml sulfuric acid solution (5.9.2.1), add 0.5 ml potassium permanganate solution, and put glass cover onto the beaker. Boil a couple of minutes, and cool down.

5.9.4.2 Preparation of the blank test solution

Same as the test solution except for no sample added.

5.9.4.3 Drawing of working curve

Conduct operation according to the procedure specified in Sec. 5.6.2.4.2 in GB/T 534–2002, and choose the standard curve that contains $0 \mu\text{g} - 1 \mu\text{g}$ of mercury.

5.9.4.4 Determinations of the sample solution and the blank solution

Conduct operations according to the procedures specified in Sec. 5.6.2.4.3 and Sec. 5.6.2.4.4 in GB/T 534–2002.

5.9.5 Calculation of the results

Calculate the results according to the procedures specified in Sec. 5.6.2.5 and Sec. 5.6.2.6 in GB/T 534–2002.

5.9.6 Handling of mercury containing wastewater

Mercury containing wastewater is collected into 50 l of container. When the wastewater reaches to about 40 l, sequentially add 400 ml of 400 g/l of sodium hydroxide solution and 100 g sodium sulfide ($\text{Na}_2\text{S} \cdot 9\text{H}_2\text{O}$), and shake well. After 10 minutes, slowly add 400 ml of hydrogen peroxide solution with mass fraction 30%, and thoroughly mix and place for 24 hours. Then, discharge the supernatant into waste water, transfer the precipitate into another container, and recycle mercury by specially-assigned personnel.

6 Inspection Rules

6.1 This standard adopts type test and delivery test.

6.1.1 All items in this standard are type tests. Normally, type tests are performed at least once per month. Type tests are conducted in any of the following cases:

- a) Change the major processing technique;
- b) Change the major ingredients;
- c) Resume manufacturing processing after downtime of production;
- d) The test results have significant differences between delivery tests and previous type tests.

6.1.2 Total alkali, sodium carbonate, arsenic, heavy metal, insoluble and organic impurities are delivery test items specified in this standard, and must be tested for each batch.

6.2 A batch is defined as continuing production of food additive of sodium hydroxide, or production by the same shift using same materials under same processing conditions. The amount of product in each batch, converted into solid alkali, is not greater than 300 tons.

6.3 Sampling unit number for food additive of solid sodium hydroxide is determined accordance to GB/T 6678. Sampler is slowly inserted to 2/3 deep of container to take sample. The samples are mixed uniformly, and total amount of sample is not less than 500 g, and then are packed into two clean and dry plastic bags or plastic bottles with plug, and close them.

For tank wagon or tank used to store food additive of liquid sodium hydroxide, the same amount of samples are taken from top, middle and bottom of container (top is liquid layer where 1/10 from liquid surface, bottom is liquid layer where 1/10 from bottom of the container), and then are mixed thoroughly. The total amount of samples is not less than 500 ml, and then put into plastic bottles and closed.

Label the plastic bottles with manufacturer name, product name, batch number or tank wagon number, sampling date and sampling person. One of the bottles is used for testing, the other one is preserved for 3 months for future reference.

6.4 The tests for food additive of sodium hydroxide must be conducted by department of quality supervision and inspection in accordance to this standard. Manufacturer must ensure product of each batch delivered comply with the requirements specified in this standard.

6.5 If testing results are not complied with the requirements in this standard, the sample must be taken from 2 fold amount of packaged product again and retested. Even if only one item does not comply with the requirement specified in this standard, the entire batch is considered as disqualified.

7 Marking and Labeling

7.1 The marking on the packaging container of food additive of sodium hydroxide must be firm and clear, which includes manufacturer name, manufacturing address, product name, “food additive” typeface, net content, batch number or production date, hazardous chemical permit number, hygiene permit number, and this standard number, as well as “causticity” mark specified in GB 190–1990, “up” and “keep dry” marks specified in GB/T191–2008, and safety mark.

7.2 Food additive of sodium hydroxide for each batch delivered must attach certificate of quality that includes manufacturer name, manufacturing address, product name, net content, batch No. or production date, certificate of quality of the product that comply with this standard, this standard number, hazardous chemical permit No., hygiene permit No., as well as material safety data sheet and safety label.

8 Packaging, Transport and Storage

8.1 Food additive of solid sodium hydroxide is packaged by metal pail or other closed container. Packaging container must comply with the related requirements. Barrelhead must be firmly closed. Net content per barrel is 200 kg.

Tank wagon or tank handling food additive of liquid sodium hydroxide must be periodically cleaned.

Plastic barrel and tank wagon are allowed to store and ship food additive of schistic sodium hydroxide or liquid sodium hydroxide as long as they are accordance with requirements in food packaging standards.

8.2 Prevent from collision and avoid transport with acid, toxic and hazardous materials during transportation of food additive of sodium hydroxide.

8.3 Food additive of sodium hydroxide must be stored in cool and dry place, avoid breakage, contamination and damp, and avoid contact with acid.

8.4 Shelf-life of food additive of sodium hydroxide is one year. It can continually be used if it possesses acceptance certificate after expiration of the shelf-life.

9 Safety

Sodium hydroxide has causticity. For anyone who possibly contacts the powder of product, the one should wear a hood or helmet with powered air–purifying respirator (PAPR), or wear self–contained breathing apparatus if necessary. Wear acid and alkali resistant rubber cloth and gloves. Prohibit smoking, eating and drinking in the working area. Wash hands before eat. Take bath after work.

Appendix M

GB 29215–2012

Food Additive – Plant Activated Charcoal



National Standard of the People's Republic of China

GB 29215–2012

National Standard for Food Safety Food Additive–Plant activated charcoal (woody activated charcoal)

Issued on: December 25, 2012

Implemented on: January 25, 2013

Issued by:

Ministry of Health of the People's Republic of China

National Standard for Food Safety

Food Additive—Plant activated charcoal (woody activated charcoal)

1 Scope

This standard is applicable to food additive of plant activated charcoal (woody activated charcoal) that is produced with physical or chemical methods by using materials of wooden meal, bamboo, coconut husk or fruit husks, etc.

2 Molecular Formula and Relative Molecular Mass

2.1 Molecular formula: C

2.2 Relative molecular mass: 12.01 (based on International Relative Atomic Mass 2007)

3 Technical Requirement

3.1 Organoleptic requirements: Meet requirements of Table 1.

Table 1 Organoleptic Requirements

Item	Requirement	Test Method
Appearance	Black	Take a suitable amount of sample and put it into a 50 ml of beaker, and observe color and state under natural light.
State	Powder or granule	

3.2 Physicochemical requirements: Meet requirements of Table 2.

Table 2 Physicochemical requirements

Item	Index	Test Method
Iodine absorbance (dry basis), mg/g \geq	400	GB/T 12496.8
Sulfate ash (dry basis), w% \leq	7.0	Appendix A, A.4
Cyanide	Pass test	GB/T 12496.14
Higher aromatic hydrocarbons	Pass test	Appendix A, A.5
Water soluble (dry basis), w% \leq	4.0	Appendix A, A.6
Arsenic (As) (dry basis), mg/kg \leq	3	Appendix A, A.7
Lrad (Pb) (dry basis), mg/kg \leq	5	Appendix A, A.8

Appendix A

Test Method

A.1 Caution

Some of reagents used in the test methods in this standard have toxicity and causticity, so take suitable safety and protection measures during operation.

A.2 General Rules

Unless otherwise noted, all the reagents and water used in this standard are analytical reagents and third grade water specified in GB/T 6682–2008, respectively. Standard titration solutions, standard solutions used to determine impurity, and preparations are implemented GB/T 601, GB/T 602 and GB/T 603, respectively. All solutions are aqueous solutions unless otherwise noted.

A.3 Identification Test

A.3.1 Reagents and materials

A.3.1.1 Hydrochloric acid solution: 5%.

A.3.1.2 Iodine solution: Dissolve 14 g of iodine and 36 g of potassium iodide in 100 ml of water, add 3 drops of hydrochloric acid and dilute to 1000 ml with water. Shake well.

A.3.2 Identification method

Take about 3.0 g of sample and put into an iodine flask that was filled 10 ml of hydrochloric acid solution previously. Boil and keep for 30 s, and cool down to room temperature. Then add 100 ml of iodine solution close the plug and shake strenuously. Filtrate with moderate speed of qualitative filter paper; discard the first 20 ml of filtrate. Transfer the filtrate into a 50 ml of colorimetric tube to the mark. Compared with the reference solution, its color is not deeper than one of reference solution.

Reference solution: Transfer 10 ml of iodine solution into a 50 ml of colorimetric tube using pipette, and dilute to the mark with water. Shake well.

A.4 Determination of sulfate ash

A.4.1 Reagents and materials

A.4.1.1 Ammonium carbonate

A.4.1.2 Sulfuric acid

A.4.1.3 Sulfuric acid solution: 1+19.

A.4.2 Apparatus and equipment

A.4.2.1 Porcelain crucible: 30 ml.

A.4.2.2 High temperature oven: temperature is controlled at $800\text{ }^{\circ}\text{C} \pm 25\text{ }^{\circ}\text{C}$

A.4.3 Analysis procedure

Weigh 0.5 g of sample with precision to 0.0002 g, and put into porcelain crucible that was dried to constant weight previously at $800\text{ }^{\circ}\text{C} \pm 25\text{ }^{\circ}\text{C}$. Add adequate amount of sulfuric acid solution to immerse entire sample. Put on an electric heat plate to heat slowly until the sample is dried and carbonized completely. Continually heat until all sample is volatilized or almost all carbon is oxidized, and cool down to room temperature. Add 0.1 ml of sulfuric acid to wet residue, and then according to the above procedure to continually heat until the residue and excess sulfuric acid are volatilized. Add a few of ammonium carbonate granules to promote volatilization of sulfuric acid. Continually heat to constant weight at $800\text{ }^{\circ}\text{C} \pm 25\text{ }^{\circ}\text{C}$.

A.4.4 Calculation of result

Mass fraction of sulfate ash w_1 , and is calculated as formula (A.1):

$$w_1 = \frac{m_1 - m_2}{m \times (100\% - w_4)} \times 100\% \quad \dots\dots\dots (A.1)$$

Where:

m_1 – Mass of residue and seramich after ignition, g;

m_2 – Mass of evaporation dish, g;

m – Mass of the sample, g;

w_4 – Mass fraction of drying loss measured according to Appendix B, %.

The test result is an average arithmetical value of replicate determinations. The difference of the absolute values of results in two parallel tests under repeated condition is not greater than 0.5%.

A.5 Test of Higher Aromatic Hydrocarbon

A.5.1 Reagents and materials

A.5.1.1 Cyclohexane.

A.5.1.2 Quinine sulfate standard using solution: 1 ml of the solution contains 0.1 μg of quinine sulfate $[(\text{C}_20\text{H}_{24}\text{N}_2\text{O}_2)_2 \cdot \text{H}_2\text{SO}_4]$.

Weigh 1.048 g of quinine sulfate $[(C_20H_{24}N_2O_2)_2 \cdot H_2SO_4]$ and put into 1000 ml of volumetric flask, and dissolve with sulfuric acid solution (3+1000), and then dilute with sulfuric acid solution to the mark line. Shake well. This solution is Quinine sulfate standard solution I, in which 1 ml of the solution contains 1 mg of quinine sulfate $[(C_20H_{24}N_2O_2)_2 \cdot H_2SO_4]$.

Transfer 1 ml of quinine sulfate standard solution I into a 100 ml of volumetric flask by pipette, and dilute with sulfuric acid solution (3+1000) to the mark line. Shake well. This solution is quinine sulfate standard solution II, in which 1 ml of the solution contains 0.01 mg of quinine sulfate $[(C_20H_{24}N_2O_2)_2 \cdot H_2SO_4]$.

Transfer 1 ml of quinine sulfate standard solution II into a 100 ml of volumetric flask by pipette, and dilute with sulfuric acid solution (3+1000) to the mark line. Shake well. This solution is quinine sulfate standard using solution, in which 1 ml of the solution contains 0.1 μ g of quinine sulfate $[(C_20H_{24}N_2O_2)_2 \cdot H_2SO_4]$. This solution is prepared just before use.

A.5.2 Apparatus and equipment

A.5.2.1 Soxhlet's extractor, see Fig. A.1.

A.5.2.2 Colorimetric tube: 10 ml.

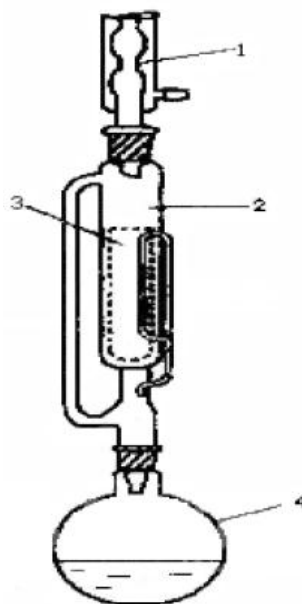

- 1 – Condensing tube;
- 2 – Soxhlet's extractor;
- 3 – Filter paper bag;
- 4 – Flask (50 ml)

Fig. A.1 Diagram of Soxhlet's Extractor

A.5.3 Analysis procedure

The sample passes 71 μm of test sieve, and is dried according to Appendix B. Weigh 1.00 ± 0.01 g of sample and wrap tightly with clean filter paper, and then put into Soxhlet's extractor, add 12.0 ml of cyclohexane, and connect the device according to Fig. A.1. In water bath at $90 - 95$ °C, continually extract for 2 h. Then, cool down the extraction solution and transfer into colorimetric tube.

Put 10 ml of quinine sulfate standard using solution into colorimetric tube.

Observe under ultraviolet lamp (365 nm), color of the sample solution or fluorescence is not greater than one of standard using solution, and the test is passed.

A.6 Determination of water soluble matter (dry basis)

A.6.1 Apparatus and equipment

A.6.1.1 Reflex condenser.

A.6.1.2 Constant temperature oven.

A.6.2 Analysis procedure

The sample passes 71 μm of test sieve and is dried according to Appendix B. Weigh 5 g of the sample with accuracy of 0.01, and put into 250 ml of dry flask with reflux condenser and Bensen valve connected. Then add 100 ml water and a couple of glass ball, then heat and reflux for 1 h. After slightly cool down, filtrate with moderate qualitative filter paper. Discard the first 10 ml of filtrate, and cool down the rest of filtrate to room temperature. Transfer 25 ml of the filtrate by pipette into evaporation dish that was dried to constant weight at 100 ± 2 °C previously. Put the evaporation dish on water bath to evaporate to almost dry. The solution is avoided to boil during evaporation, and is dried to constant weight at 100 ± 2 °C. This filtrate is preserved for determining arsenic.

A.6.3 Calculation of the result

Mass fraction of water soluble matter w_2 , is calculated according to formula (A.2):

$$w_2 = \frac{m_1 - m_2}{m \times (25/100)} \times 100\% \quad \dots\dots\dots (A.2)$$

Where:

m_1 – Mass of residue and evaporate dish, the unit is g;

m_2 – Mass of evaporation dish, the unit is g;

m – Mass of the sample, the unit is g;

25 – Volume of transferred test solution, the unit is ml;

100– Volume of water added, the unit is ml.

Test result is an average arithmetical value of replicate determinations. The difference of the absolute values of the two parallel tests under repeated condition is not greater than 0.3%.

A.7 Determination of arsenic (As)

Transfer 200 ml of preserved filtrate A (A.6.2) into an iodine flask as the test solution, and then follow GB/T 5009.76 to conduct the determination.

A.8 Determination of lead (Pb)

A.8.1 Abstract of the method

Lead ion is extracted using water contained nitric acid, and determined using atomic absorption spectrophotometer with air-acetylene flame and working curve.

A.8.2 Reagents and materials

A.8.2.1 Nitric acid;

A.8.2.2 Nitric acid solution: 1+5;

A.8.2.3 Lead (Pb) standard solution: 0.10 mg/ml;

A.8.2.4 Water: meet the requirements of second grade water specified in GB/T 6682–2008.

A.8.3 Apparatus and equipment

Atomic absorption spectrophotometer: equipped with hollow cathode lamp.

A.8.4 Determination procedure

A.8.4.1 Cleaning apparatus

Immerse glass apparatus in nitric acid solution for overnight, then rinse thoroughly with flowing water, and finally rinse to clean by water.

A.8.4.2 Preparation of working curve

Transfer 0 ml, 0.50 ml, 1.00 ml, 1.50 ml of lead standard solution into four of 50 ml of volumetric flasks, respectively, and diluted with water to the mark. Shake well. Absorbency of the above solution is measured using atomic absorption spectrophotometer with air-acetylene flame at 283.3 nm of wave-length under optimum operation conditions. 0 point is adjusted by water.

Absorbency of the standard solution subtracts absorbency of the blank solution, and set concentration of lead as horizontal coordinate and the corresponding absorbency as vertical coordinate, and draw up the working curve.

A.8.4.3 Measurement

Weigh 5 g of the test sample with accuracy of 0.0002 g, and put into a conical beaker. Add 50 ml of water and 1 ml of nitric acid in it, and put it on electric stove to heat to just boiling for 10 min. slightly cool it down. The solution is filtered by moderate speed qualitative filter paper, and washed 3–5 times using small amount of water. The washing water is combined with filtrate, and put into 50 ml of volumetric flask, cool down to room temperature, and dilute to the mark with water. Shake well.

Measure absorbency of the test solution using atomic absorption spectrophotometer with air-acetylene flame at 283.3 nm of wave-length under optimum operation conditions. Adjust 0 point by water. According to the absorbency, concentration of lead (mg/l) in the test solution can be obtained from the working curve.

A.8.5 Calculation of the result

Mass fraction of lead (Pb) w_3 , its value is expressed as mg/kg, and is calculated by formula (A.3):

$$w_3 = \frac{\rho \times 0.05 \times 1000}{m \times (100\% - w_4)} \dots\dots\dots (A.3)$$

Where:

ρ – Concentration of lead obtained from working curve, the unit is mg/l;

m – Mass of the sample, the unit is g;

w_4 – Mass fraction of drying loss according to Appendix B, %;

0.05 – Volume of volumetric flask, the unit is L;

100 – Factor of conversion.

Test result is an average arithmetical value of replicate determinations. The difference of the absolute values of the two parallel tests under repeated condition is not greater than 2 mg/kg.

Appendix B

Determination of Drying Loss

B.1 Apparatus and equipment

Weighing bottle: $\phi 50$ mmX30 mm.

B.2 Analytical procedure

Weigh 1–2 g of sample with precision to 0.0002 g using weighing bottle that was dried to constant weight at 120 ± 2 °C. Then dry it at 120 ± 2 °C for 4h, cool down to room temperature in desiccator, and then weigh.

B.3. Calculation of the result

Mass fraction of drying loss w_4 is calculated as formula (B.1):

$$w_4 = \frac{m_1 - m_2}{m} \times 100\% \quad \dots\dots\dots (B.1)$$

Where:

m_1 – Mass of sample and weighing bottle before drying, the unit is g;

m_2 – Mass of sample and weighing bottle after drying, the unit is g;

m – Mass of the sample, the unit is g;

Test result is an average arithmetical value of replicate determinations. The ratio between the absolute difference of two parallel tests under repeated condition and the average arithmetical value is not greater than 2%.

Appendix N

GB/T 16579–2013

D001 Macroporous Strongly Acidic Styrene Type Cation Exchange Resins

ICS 83.080.10
G 32



National Standard of the People's Republic of China

GB/T 16579–2013
Replace GB/T 16579–1996

D001 Macroporous Strongly Acidic Styrene Type Cation Exchange Resins

Issued on: September 6, 2013

Implemented on: January 31, 2014

Issued by: **General Administration of Quality Supervision, Inspection and
Quarantine of the People's Republic of China; and
Standardization Administration of the People's Republic of China**

Foreword

This standard is drafted according to the regulations specified in GB/T 1.1–2009.

This standard replaces GB/T 16579–1996 D001 *Macroporous Strongly Acidic Styrene Type Cation Exchange Resins*. Compared with GB/T 16579–1996, the major technical changes are as following:

- Withdraw the grading of “premium grade”, “second grade” and “qualified grade” for various products.
- Add D001 TR classification and the corresponding index, the requirement of “range of particle size” is “(0.710 mm–1.250 mm), $\geq 95\%$ ”, “lower limit of granularity” is “(<0.710 mm) $\leq 1\%$ ”.
- Revise “exchange capacity” index to “ ≥ 4.35 mmol/g”;
- Revise “volume exchange capacity” index to “ ≥ 1.8 mmol/ml”;
- Revise “water content” index to “45.0%–55.0%”;
- Revise “wet bulk density” index to “0.77g/ml–0.85 g/ml”;
- Revise “wet true density” index to “1.24 g/ml–1.28 g/ml”;
- Revise “effective particle diameter” index for D001 to “ ≥ 0.40 mm”, “coefficient of uniformity” index to “ ≤ 1.6 ”.
- Revise “effective particle diameter” index for D001FC to “ ≥ 0.50 mm”;
- Revise “effective particle diameter” index for D001SC to “ ≥ 0.63 mm”;
- Revise “effective particle diameter” index for D001MB to “0.55 mm–0.90 mm”, “range of granularity” to “(0.500 mm–1.250 mm) $\geq 95\%$ ”;
- Revise “sphericity of osmotic attrition” index to “ ≥ 90 ”.

This standard was proposed by China Petroleum and Chemical Industry Association.

This standard is under the jurisdiction of National Standardization Technical Committee for Plastic Products, General methods and products subcommittee (SAC/TC 15/SC 4).

Principle drafting organizations for this standard: Jiangsu Suqing Water Treatment Engineering Group Co., Ltd.; Xian Thermal Power Research Institute; Ningbo Zhengguang Resin Co., Ltd.; Zibo Dongdahuagong Co., Ltd.; National Quality Supervision and Test Center for Synthetic Resin.

Principal drafters for this standard: Huiping Jiang; Huanfang Cui; Jianhua Shen; Zhanghua Peng; Ping Zhao; Jinghua Zhai.

The previous issued edition replaced by this standard:

— GB/T 16579-1996.

D001 Macroporous Strongly Acidic Styrene Type Cation Exchange Resins

1 Scope

This standard specifies the classification of products, requirements, testing method, inspection rule, marking and labeling, packaging, transportation, and storage for D001 macroporous strongly acidic styrene type cation exchange resin.

This standard is applicable to D001 macroporous strongly acidic styrene type cation exchange resin that contains sodium sulfonate. This product is mainly used for water softening, preparation of pure water and hydrometallurgical processing.

2 Normative Reference Standards

The following standards are necessary for the applications of this standard. For the dated references, only the dated editions are applicable to this standard. For undated references, the latest edition of the normative document referred to applies.

GB/T 1631 Nomenclature and Fundamental Standard

GB/T 5475 Sampling Methods for Ion Exchange Resins

GB/T 5476 Pretreatment Methods for Ion Exchange Resins

GB/T 5757 Determination Methods for Water Content Of Ion Exchange Resins

GB/T 5758 Determination of Particle Size, Effective Particle Diameter, and Coefficient of Uniformity for Ion Exchange Resins

GB/T 8144 Determination Methods for Exchange Capacity of Cation Exchange Resins

GB/T 8330 Determination Methods for Wet True Density of Ion Exchange Resins

GB/T 8331 Determination Methods for Wet Bulk Density of Ion Exchange Resins

GB/T 12598 Determination for Sphericity of Osmotic Attrition and after Attrition for Ion Exchange resins

3 Classification of Product

The type No. for D001 macroporous strongly acidic styrene type cation exchange resins is organized according to GB/T 1631. MB represents special mixed-bed; FC represents special floated-bed; SC represents special stratified-bed; TR represents tribed.

4 Requirement

4.1 Appearance

Opaque particles with camel or brown color.

4.2 Delivery type

Sodium type.

4.3 Technical requirements

Technical requirements must meet Table 1

Table 1 The Technical Requirements for D001 Macroporous Strongly Acidic Styrene Type Cation Exchange Resins (Sodium Type)

Item	D001	D001FC	D001SC	D001MB	D001TR
Exchange capacity (mmol/g)	≥ 4.35				
Volume exchange capacity (mmol/ml)	≥ 1.8				
Water content % (mass fraction)	45.0 – 55.0				
Wet bulk density (g/ml)	0.77 – 0.85				
Wet true density (g/ml)	1.21 – 1.28				
Effective particle diameter (mm)	≥ 0.4	≥ 0.5	≥ 0.63	(0.55-0.90)	–
Coefficient of uniformity	≤ 1.6		≤ 1.4		–
Range of particle size (%)	(0.315–1.250mm) ≥ 95	(0.450–1.250mm) ≥ 95	(0.630–1.250 mm) ≥ 95	(0.500–1.250 mm) ≥ 95	(0.710–1.250 mm) ≥ 95
Lower particle size (%)	(<0.315 mm) ≤ 1	(<0.450 mm) ≤ 1	(<0.630 mm) ≤ 1	(<0.550 mm) ≤ 1	(<0.710 mm) ≤ 1
Sphericity of osmotic attrition (%)	≥ 90				

5 Test Method

5.1 Appearance

Observe visually.

5.2 Pretreatment of sample

Treat according to the method specified in GB/T 5476.

5.3 Determinations of exchange capacity and volume exchange capacity

5.3.1 Determination of exchange capacity

Determine according to the method specified in GB/T 8144, and the result is accurate to the second decimal place.

5.3.2 Calculation of volume exchange capacity

Volume exchange capacity is calculated as formula (1), and the result is accurate to the second decimal place:

$$Q_v = Q_w \cdot \rho (1 - w) \quad \dots\dots\dots (1)$$

Where:

Q_v – Volume exchange capacity, the unit is mmol/ml;

Q_w – Exchange capacity, the unit is mmol/g;

ρ – Wet bulk density, the unit is g/ml;

w – Water content, %.

5.4 Determination of water content

Determine according to the method specified in GB/T 5757, and the result is accurate to the second decimal place.

5.5 Determination of wet bulk density

Determine according to the method specified in GB/T 8331, and the result is accurate to the second decimal place.

5.6 Determination of wet true density

Determine according to the method specified in GB/T 8330, and the result is accurate to the second decimal place.

5.7 Determinations of effective particle diameter and coefficient of uniformity

Determine according to the method specified in GB/T 5758, and the result for effect particle diameter is accurate to the second decimal place. For coefficient of uniformity, the result is accurate to the first decimal place.

5.8 Determination of particle size

Determine according to the method specified in GB/T 5758, and the result of range of particle size is accurate to the second decimal place. The result for lower limit of particle size is accurate to the first decimal place.

5.9 Determination of sphericity of osmotic attrition

Utilize the original sample, and determine according to the test method specified in GB/T 12598. The result is accurate to the second decimal place.

6 Inspection Rules

6.1 Classification of tests and testing items

Tests of product are classified into delivery test and type test.

6.1.1 Delivery test

Manufacturer must conduct delivery test for each batch of product. The exchange capacity, volume exchange capacity, water content, wet bulk density, wet true density, particle size, and sphericity of osmotic attrition in Table 1 are at least delivery test items. The other delivery test items may be added if both parties of supplier and customer have consensus.

6.1.2 Type test

All test items listed in Table 1 are type tests. In normal cases, the type tests must be performed once half year. If in one of the following cases, the type tests must also be performed:

- a) New product is put in production, or the production is transferred to other place;
- b) After formal production, product formula, processing technique or raw materials have changed;
- c) when production down time exceeds 1 month, and resumed to start the production;
- d) If there are significant differences between the results of delivery test and type test.

6.2 Sampling method

Conduct according to the method specified in GB/T 5475.

6.3 Judgment rules and re-inspection

6.3.1 Judgment rules

The product must be tested according to the test methods set in this standard by the department of quality inspection. The quality judgment for the product is made based on the test results and requirements set in this standard, and certificate of the product is provided.

When product is delivered, each batch of product must attach the quality test certificate that contains product name, specification, batch No., standard implemented, and on that special seal of quality inspection is affixed.

6.3.2 Re-inspection rules

If one of the test results is not meet the requirements of Table 1, double sampling should be taken, and the failed item needs to be re-inspected. Re-inspection must be conducted twice. If results of the two re-inspections both are meet the requirement of this item, the product is judged to be qualified, otherwise it is not qualified.

7 Labeling, packaging, transportation and storage

7.1 Labeling

The outer package of product must contain clear labeling. The labeling contents include: manufacturer name, product name, specification, standard implemented by product, and net content, etc.

7.2 Packaging

Product is packaged in polywoven bag lined with plastic bag, or other packaging manner. Packaging materials must not be contaminated and leaked during transportation and storage.

7.3 Transportation

Transportation of the product belongs to non-dangerous article transportation. During transportation, the product should be kept at 5–40 °C of environment, avoidance of overcooling or overheating, and taken cautions to prevent from water loss of product.

7.4 Storage

The product is stored in cool indoor place at temperature specified in 7.3. Shelf-life is 2 years. When storage time exceeds the shelf-life of product, the type test can be conducted, and the product still can be used normally, if the test results meet the requirements.

Appendix O

HG 2165-91

D301 Macroporous Weakly Basic Styrene Type Anion Exchange Resins

Chemical Industry Standard of the People's Republic of China

HG 2165-91

D301 Macroporous Weakly Basic Styrene Type Anion Exchange Resins

1 Subject Content and Scope of Application

This standard specifies technical requirements, test methods, inspection rules, and labeling, packaging, transportation, and storage for D301 macroporous weakly basic styrene type anion exchange resin.

This standard is applicable to D301 macroporous weakly basic styrene type anion exchange resin with particle size in range of 0.315–1.25 mm, and it mainly contains tertiary amino group.

2 Normative Reference Standards

- GB 1631 Nomenclature and Fundamental Standard
- GB 5475 Sampling Methods for Ion Exchange Resins
- GB 5476 Pretreatment Methods for Ion Exchange Resins
- GB 5758 Determination of Particle Size, Effective Particle Diameter, and Coefficient of Uniformity for Ion Exchange Resins
- GB 5759 Determination Method for Water Content of Anion Exchange Resins in Hydroxylic Form
- GB 5760 Determination Method for Exchange Capacity of Anion Exchange Resins
- GB 8330 Determination Methods for Wet True Density of Ion Exchange Resins
- GB 8331 Determination Methods for Wet Bulk Density of Ion Exchange Resins
- GB 11991 Determination of Reversible Swelling of Exchange Resins
- QB/T 12598 Determination Method for Strength Osmotic-Attrited Method

Approved by Ministry of Chemical Industry on November 18, 1991 Implemented on May 1, 1992

3 Product Models and Major Usages

The models of D301 macroporous weakly basic styrene type anion exchange resins are organized according to GB 1631. This product is mainly used for water treatment.

4 Technical Requirement

4.1 Appearance

Opaque particles with milky white or light yellow color.

4.2 Delivery type

Unhindered amine type.

4.3 Physicochemical characteristics

Physicochemical characteristics must meet the following Table.

Item		Index		
		Premium	First grade	Qualified
Water content, %		50-60	45-65	
Full mass exchange capacity, mmol/g	≥	4.8	4.6	4.2
Full volume exchange capacity, mmol/ml	≥	1.5	1.4	1.3
Wet bulk density, g/ml		0.65-0.72		
Wet true density, g/ml		1.03-1.07		
Particle size, %	0.315-1.25 mm	≥ 95		
	Less than 0.315 mm	≤ 1		
Effective particle diameter, mm		0.45-0.70		
Coefficient of uniformity		≤ 1.6	1.7	
Sphericity of osmotic attrition (%)		≥ 95	90	85

5 Test Method

5.1 Appearance

Observe visually.

5.2 Pretreatment of sample

Treat according to the method specified in GB/T 5476.

5.3 Determination of water content

Determine according to the method specified in GB/T 5759.

5.4 Determination for full mass exchange capacity and full volume exchange capacity

5.4.1 Determinations for full mass exchange capacity

Determine according to the method specified in GB 5760.

5.4.2 Calculation for full volume exchange capacity

Full volume exchange capacity is calculated as formula (1):

$$Q_v = Q_w \cdot \rho (1 - w) \dots\dots\dots (1)$$

Where:

Q_v – Full volume exchange capacity, mmol/ml;

Q_w – Full mass exchange capacity, mmol/g;

ρ – Wet bulk density, g/ml;

w – Water content, %.

5.5 Determination of wet bulk density

Determine according to the method specified in GB/T 8331.

5.6 Determination of wet true density

Determine according to the method specified in GB/T 8330.

5.7 Determinations for particle size

Use sieves with 0.315 mm and 1.25 mm of aperture, and sieve according to the method specified in GB/T 5758. Calculate in accordance with formula (2) and formula (3):

$$P_1 = \frac{V_0 - V_1 - V_2}{V_0} \times 100 \dots\dots\dots (2)$$

$$P_2 = \frac{V_1}{V_0} \times 100 \dots\dots\dots (3)$$

Where:

P_1 – Resin particle size with 0.315–1.25 mm of particle diameter of test sample, %;

V_0 – Volume of test sample, ml;

V_1 – Resin volume with less than 0.315 mm of particle diameter of test sample, ml;

V_2 – Resin volume with greater than 1.25 mm of particle diameter of test sample, ml;

P_2 – Resin particle size with less than 0.315 mm of particle diameter of test sample, %.

5.8 Determination for effective particle diameter and coefficient of uniformity

Determine the determinations according to the methods specified in GB 5758.

5.9 Determination of sphericity of osmotic attrition

Sieves 0.50–0.63 mm of test sample in accordance with the method specified in GB 5758, and then determine according to GB/T 12598.

6 Inspection Rules

6.1 Resin produced in each tank is defined as a batch of product.

6.2 Sampling is conducted according to the method specified in GB/T 5475.

6.3 Department of quality inspection must test every batch of product, and ensure that all products meet various technical requirements specified in this standard.

6.4 In this standard, appearance, water content, full mass exchange capacity, full volume exchange capacity, wet bulk density and sphericity of osmotic attrition are delivery test items; wet true density, particle size, and effective particle diameter are random test items. Coefficient of uniformity is also a delivery test item for premium grade product, and is a random test item for first grade and qualified grade. Random test items must be random tested at least once per month. Type tests are conducted according to 6.6.1 in GB 1.3.

6.5 The user of products have right to conduct tests according to this standard when products are received. If re-inspection is needed, user should require manufacturer to do so within 3 months after the products are received.

6.6 If one of the test results does not meet the requirement specified in this standard, double sampling amount is taken from the same batch of product, and is re-inspected. The product grade is determined by the re-inspection results.

6.7 When there is dissent for the quality of product between supplier and customer, both parties should compromise settlement, or require a legal quality inspection agency to arbitrate.

7 Labeling, Packaging, Transportation and Storage

7.1 Marking and labeling

Every batch of product should have a certificate for the quality tests. On every package, there must have clear and firm labeling that contains product name, model No., grade, batch No., net weight, production date and manufacturer name.

7.2 Packaging

Product is packaged in container or polywoven bag lined with plastic bag and every package attaches certificate of the product.

7.3 Transportation

During transportation, keep the product at 5–40 °C of environment, avoid overcooling or overheating, and take cautions to prevent from water loss of product. This product is non-dangerous article.

7.4 Storage

The product is stored at temperature specified in 7.3; its shelf-life is 2 years. When storage time exceeds the shelf-life, the product can be re-inspected according to this standard. If the results of re-inspection meet the requirements specified in this standard, the product still can be used.

Appendix A

Reversible Swelling of D301 Macroporous Weakly Basic Styrene Type Anion Exchange Resins

(Reference Document)

A1 Reversible swelling from free alkali type to chlorine type for this product is less than or equal to 28%.

A2 The test method uses the one specified in GB 11991.

Additional Statements:

This standard was proposed by Ministry of Chemical Industry of the People's Republic of China.

This standard is under the jurisdiction of Subcommittee of Plastic and Resin Products, National Plastic Standardization Committee of China.

This standard was drafted by, and in charge of Zhejiang Yuhang Zhengguang Chemicals Factory.

The principle drafters are Congzhi Wu; Jiu Hua Zhu; and Ying Wang.

Appendix P

GB/T 20881–2007

Isomaltooligosaccharide

ICS 67.180.20
X 31



National Standard of the People's Republic of China

GB/T 20881–2007

Isomaltooligosaccharide

Issued on: February 2, 2007

Implemented on: December 1, 2007

Issued by: **General Administration of Quality Supervision, Inspection and Quarantine of the People's Republic of China; and Standardization Administration of the People's Republic of China**

Contents

Foreword.....	3
Introduction.....	4
1 Scope	5
2 Normative References	5
3 Term and Definition, Symbol	6
4 Classification of Products	6
5 Requirement.....	6
6 Test Method	7
7 Inspection Rule	11
8 Labeling, Packaging, Transportation and Storage	12
Annex A (Reference Annex) IMO Content (HPLC Double Column)	14

Foreword

This standard is first drafted based on QB/T 2491–2004 *Isomaltooligosaccharide*.

From the implementation date of this standard, QB/T 2491–2004 will be void by default.

Annex A in this standard is a reference annex.

This standard was proposed by and is under the jurisdiction of Subcommittee of Industrial Fermentation of National Technical Committee 64 on Food Industry of Standardization Administration of China.

The drafting organization for this standard: China Research Institute of Food and Fermentation Industries; Shandong Baolingbao Biology Co., Ltd.; Luzhou Biotechnology (Shandong) Co., Ltd.; Shanghai Rongs Co., Ltd.

Principal drafters for this standard: Xinguang Guo; Naiqiang Wang; Jichao Niu; Haihua Xie; Yuanxing Bao.

Introduction

Content of isomaltooligosaccharide (IMO) is an important technical index, so its test method is vital. Internationally, it is normally tested using high performance liquid chromatography (HPLC) with Double columns. However, this method cannot reflect the affect of dextrin on quality of product, single column method is better to resolve this issue. Considering China's actual conditions, the single column method will be an arbitration method. The double column method is placed in Annex as a reference for manufacturers in order to compare with tests of foreign counties.

Isomaltooligosaccharide

1 Scope

This standard specifies term and definition, symbol, classification of products, requirements, test methods, inspection rules, labeling, packaging, transportation and storage for isomaltooligosaccharide.

This standard is applicable to isomaltooligosaccharide.

2 Normative Reference Standards

The following standards contain provisions which, through reference in this text, constitute provisions of this standard. For the dated references, subsequent amendments to (error corrections not included) or revisions of, any of these publications will be not applicable to this standard. However, the parties to agreements based on this standard are encouraged to investigate the possibility of applying the most recent editions of the standards. For undated references, the latest edition of the normative document referred to applies.

GB/T 191 Packaging— Pictorial Marking for Handling of Goods (GB/T 191–2000, equivalence to ISO 780:1997)

GB/T 4789.2 Microbiological Determination for Food Hygiene. Examination of Total Count of Bacteria

GB/T 4789.3 Microbiological Determination for Food Hygiene. Examination of *Coliform*

GB/T 4789.4 Microbiological Determination for Food Hygiene. Examination of *Salmonella*

GB/T 5009.11 Determination for Total Arsenic and Inorganic Arsenic in Food

GB/T 5009.12 Determination for Lead in Food

GB/T 6682–1992 Water Specification and Test Methods for Analytical Laboratory (not equivalent to ISO 3696:1987)

GB 7718 General Rules for Labeling of Prepackaged Food

GB 15203 Hygienic Standards for Starch Sugar

GB/T 20884–2007 Maltodextrin

GB/T 20885–2007 Glucose Syrup

3 Term and Definition, Symbol

3.1 Term and definition

The following terms and definitions are applicable to this standard.

3.1.1 Isomaltooligosaccharide (IMO)

IMO is one of starch sugar, its major components are oligosaccharides with α -1,6-glucosidic bond, including isomaltose (IG_2), panose (P), isomaltotriose (IG_3) and tetresaccharide or higher saccharides (including tetresaccharides).

3.2 Symbol

The following symbols are used in this standard.

IMO: Isomaltooligosaccharide

IG_2 : Isomaltose

P: Panose

IG_3 : Isomaltotriose

G_n : Tetresaccharides or higher saccharides (including tetrasaccharides)

4 Classification of Product

4.1 Based on the form of the product, it can be classified as:

Isomaltooligosaccharide syrup and isomaltooligosaccharide powder.

4.2 Based on IMO Content, it can be classified as:

IMO-50: $IG_2 + P + IG_3 + G_n \geq 50\%$ (on dry basis).

IMO-90: $IG_2 + P + IG_3 + G_n \geq 90\%$ (on dry basis).

5 Requirement

5.1 Organoleptic requirements

The syrup is colorless or light yellow and transparent viscous liquid with light and gentle sweetness, odorless, and no visible impurities.

The powder is white and amorphous powder with light and gentle sweetness, odorless, and no visible impurities.

5.2 Physicochemical requirements

Physicochemical indexes must meet requirements specified in Table 1.

Table 1 Physicochemical Requirement for Isomaltooligosaccharides

Items	Specifications			
	IMO-50		IMO-90	
	Syrup	Powder	Syrup	Powder
IMO (% , dry basis) \geq	50		90	
IG ₂ +P+IG ₃ (% , Dry basis) \geq	35		45	
Dried Solid (%) \geq	75	—	75	—
Moisture (%) \leq	—	5	—	5
pH	4.0 – 6.0			
Transmittance (%) \geq	95	—	95	—
Solubility (%) \geq	—	99	—	99
Sulphate Ash (%) \leq	0.3			

5.3 Hygienic requirements

Must be compliant with requirements specified in GB 15203.

6 Test Method

Unless otherwise noted, water used in this standard must meet specifications of the third grade and above specified in GB/T 6682-1992; all reagents are analytical reagents (AR) unless otherwise noted.

6.1 Organoleptic test

6.1.1 Sugar syrup

Take 30 ml of sample into a colorless, clean and dry beaker (or 50 ml of small beaker), put it in bright place and observe its color and clarity visually. Inspect if there is visible impurity using normal vision. Take sample using glass rod and put it into mouth to taste (before taste the second sample, mouth must be washed using water). Make record.

6.1.2 Sugar powder

Take a suitable amount of sample, and observe its color, morphological character, and impurity. Take small amount of samples and put it into mouth, and carefully taste it (before taste the second sample, wash mouth using water). Make record.

6.2 IMO content (HPLC)

6.2.1 Principle

When various components are entered into the chromatographic column at the same time, since they have different solubility, absorption, penetration or ion exchange effects between mobile phase and immobile phase, the components flow with the mobile phase, and are repeatedly distributed in mobile and immobile phases. Because different components have different flowing rates in the chromatographic column, so the components are separated after passing a certain length of the column, and outflow from the column sequentially. The components then enter into signal detector, and peak values of various components are shown on the recorder or data processing device. Qualitative analytical results of the components are obtained based on the retention times. Quantitative analytical results of the components are obtained based on the peak areas using external reference method.

6.2.2 Apparatus

6.2.2.1 HPLC (equipped with differential refraction detector and constant temperature column system).

6.2.2.2 Vacuum degasser for mobile phase, and 0.2 μm and 0.45 μm of microporous membranes.

6.2.2.3 Chromatographic column: Amino bonded column, TSKgel Amide–80, diameter of packing material: 5 μm ; column size: ϕ 4.6 mm X 250 mm, or other chromatographic column that has similar analytical results.

6.2.2.4 Analytical balance: Precision to 0.1 mg.

6.2.2.5 Microsyringe: 10 μl .

6.2.3 Reagents

6.2.3.1 Water: Redistilled water or ultrapure water;

6.2.3.2 Acetonitrile: Chromatographic purity;

6.2.3.3 Standards of glucose, maltose, isomaltose, maltotriose, panose, isomaltotriose, maltotetraose, isomaltotetraose, maltopentaose, maltohexaose, with purity 95% or above. Prepare a series of standard solutions with 6 different concentrations within range of 0.5 mg/ml–10 mg/ml for each of the sugar.

6.2.4 Analysis procedure

6.2.4.1 Preparation of sample solution

Weigh 0.5 g of sugar syrup or sugar powder (dry basis, ensure the contents of each of components is within the range of the standard solutions, otherwise increase or decrease the sample amount) with accuracy of 0.0001 g, dissolve in water and transfer into a 50 ml of volumetric flask, then dilute to the mark. Filter the solution using 0.2 μm or 0.45 μm of aqueous microporous membrane, and the filtrate is ready for use.

6.2.4.2 Chromatographic condition

Mobile phase is acetonitrile:water = 67:33 (volume ratio). Connect the power of differential refraction detector in a day before the test, adjust the temperature of column to 75 °C, and lead the mobile phase into the column at velocity of 0.1 ml/min. Before the sample solution is formally injected, input all mobile phase in a reference cell for 20 min or above. Then resume to normal flow route that the mobile phase flows through the sample cell. Adjust velocity of the mobile phase to 0.1 ml/min until the base line is stable. Then inject 5 μl–10 μl of the sample solution.

6.2.4.3 Drawing of standard curve

After each series of sugar standard solution are injected, the standard curve is drawn out as relationship of concentrations *via* peak areas. The linearly dependent coefficient is 0.9990 or above.

6.2.4.4 Measurement of sample

Inject the sample solution prepared in 6.2.4.1. According to retention time, qualitatively determine chromatographic peaks of different components in the sample. According to peak areas, calculate the content (mass) for each of components using external reference method.

6.2.4.5 Calculation of the result

Calculate the contents of sugars in accordance with formula (1); its value is expressed as %.

$$X_i = \frac{A_i m_s V}{A_s m V_s} \times 100 \quad \dots\dots\dots (1)$$

Where:

X_i – Percentage content of a sugar component in sample [mass fraction (dry basis)], %;

A_i – Peak area of a sugar component in sample;

M_s – Mass of a sugar standard in standard solution, the unit is g;

V – Volume of diluted sample solution, the unit is ml;

A_s – Peak area of a sugar component in standard solutions;

m – Mass of sample, the unit is g;

V_s – Volume of diluted standard solution, the unit is ml.

6.2.5 Precision

The difference between the absolute values of the results of 2 separate tests under repeatable condition is not greater than 1% of mean arithmetical value.

6.3 Dry matter (solid content)

Test according to Sec. 6.2 in GB/T 20885–2007.

6.4 Moisture

Test according to Sec. 6.3 in GB/T 20884–2007.

6.5 pH

Test according to Sec. 6.4 in GB/T 20885–2007.

6.6 Transmittancy

Test according to Sec. 6.5 in GB/T 20885–2007.

6.7 Solubility

Test according to Sec. 6.4 in GB/T 20884–2007.

6.8 Sulfated ash

Test according to Sec. 6.8 in GB/T 20885–2007.

6.9 Arsenic

Test according to GB/T 5009.11.

6.10 Lead

Test according to GB/T 5009.12.

6.11 Total count of bacteria

Test according to GB/T 4789.2.

6.12 Coliform

Test according to GB/T 4789.3.

6.13 Salmonella

Test according to GB/T 4789.4.

7 Inspection Rules

7.1 Batch

Product manufactured with same raw materials, formula, and processing, and with one-time feeding is considered as a batch. The maximum of batch amount is not exceeded to output per man shift. Every batch of product must be tested and qualified by department of quality inspection of manufacturer before delivery, and quality certificate is attached.

7.2 Sampling method

For bottle or barrel packaged product, sampling according to the requirements in Table 2 and Table 3, respectively.

Table 2 Sampling for Bottle Packaged of IMO

Range of Batch, Carton	Sampling Number, Carton	Sampling package number, Bottle
<100	4	1
100–250	6	1
251–500	10	1
>500	20	1

Table 3 Sampling for Barrel Packaged of IMO

Range of Batch, Barrel	Sampling Number, Barrel
<50	2
50–100	4
>100	6

7.2.2 Every tanker packed product must be tested.

7.2.3 For barrel and tanker packaged product, sample must be taken from the location where 10 cm below to the liquid surface. The sampler must meet hygienic standards.

7.2.4 For tanker packaged product, each sampling amount is not less than 2 kg; for barrel packaged product, each sampling amount is not less than 1 kg; for bottle packaged product, total of sampling amount is not less than 600 g.

7.2.5 The samples were mixed well and divided into two parts, and signed and sealed. Stick label that contains product name, manufacturer name and address, batch No., sampling date and location, sampler name. One is sent to laboratory for testing; the other one is sealed and preserved for half month for future reference. If microbiological tests are performed, the sampling device and glass bottles must be sterilized in advance (sample is not allowed to contact the bottle mouth).

7.3 Delivery test

Delivery test items: organoleptic, moisture, dry matter (solid content), pH, transmittance, solubility, content of IG_2+P+IG_3 , and IMO content.

7.4 Type test

Type tests are all items specified in this standard. Generally, type tests are conducted once semiannually. In the following cases, they also need to conduct tests.

- a) Raw and auxiliary materials have significant changes;
- b) Critical processing or equipment is changed;
- c) Newly developed product or normal production has down time for 3 months, and then resume the production;
- d) Test results between delivery tests and last type tests have significant difference;
- e) National quality supervision and inspection agency requires random inspection according to related requirement.

7.5 Judgment rules

If test results of organoleptic or 1–2 of physicochemical items are not qualified, take double amount of sample from the same batch of product, and retest the unqualified items, if one of the items is still not qualified, so the entire batch of product is judged as unqualified.

8 Labeling, Packaging, Transportation and Storage

8.1 Labeling

8.1.1 The labeling for direct edible prepackaged product must be compliance with GB 7718.

8.1.2 When product is used as raw and auxiliary material, label must put on the package container, label contents include product name, manufacturer name, net content, batch No., production date, shelf-life, and implemented standard number.

8.1.3 Pictorial marks of packaging, transportation and storage must meet specifications in GB/T 191.

8.2 Packaging

Packaging materials and container must be clean, hygienic, no damage, and meet the related requirements specified in <*Food Hygiene Law of People's Republic of China*>.

8.3 Transportation and storage

8.3.1 During transportation, prevent product from dust, flies, strong sunlight, and rain. Inhibit the product from mixing pack and transportation with toxic, hazardous, caustic matters and contaminants. Loading and unloading must meet the requirements in pictorial marks on the outer package.

8.3.2 Finished product must be stored in dry, circulated and clean warehouse, and follow the rule of first in and first out.

Annex A

(Reference Annex)

IMO Content (HPLC)

A.1 Principle

When various components are entered into the chromatographic column at the same time, since they have different solubility, absorption, penetration or ion exchange effects between mobile phase and immobile phase, the components flow with the mobile phase, and are repeatedly distributed in mobile and immobile phases. Because different components have different flowing rates in the chromatographic column, so the components are separated after passing a certain length of the column, and outflow from the column sequentially. The components then enter into signal detector, and peak values of various components are shown on the recorder or data processing device. Qualitative analytical results of the components are obtained based on the retention times. Quantitative analytical results of the components are obtained based on the peak areas using normalization method.

A.2 Apparatus

A.2.1 HPLC (equipped with differential refraction detector and constant temperature column system).

A.2.2 Vacuum degasser for mobile phase, and 0.2 μm and 0.45 μm of microporous membranes.

A.2.3 Chromatographic column

a) Calcium type cation exchange column: Amines HPX-42A (BIO-RAD), diameter of packing material: 5 μm ; column size: $\phi 7.8 \text{ mm} \times 300 \text{ mm}$, or other chromatographic column that has similar analytical results.

b) Amino bonded column: TSKgel Amide-80, diameter of packing material: 5 μm ; column size: $\phi 4.6 \text{ mm} \times 250 \text{ mm}$, or other chromatographic column that has similar analytical results.

A.2.4 Analytical balance: Precision to 0.1 mg.

A.2.5 Microsyringe: 10 μl .

A.3 Reagents

A.3.1 Water: Redistilled water or ultrapure water;

A.3.2 Acetonitrile: Chromatographic purity;

A.3.3 Use the standards of glucose, maltose, isomaltose, maltotriose, panose, isomaltotriose, maltotetraose, isomaltotetrose, maltopentaose, maltohexaose, with purity 95% or above, to prepare 0.5% aqueous solutions, respectively.

A.4 Analysis procedure

A.4.1 Preparation of sample solution

Weigh 0.5 g of sugar syrup or sugar powder (dry basis) with precision to 0.0001 g, dissolve in water, and transfer into a 50 ml volumetric flask, then dilute to the mark. Filter the solution using 0.2 μm or 0.45 μm of aqueous microporous membrane, and the filtrate is ready for use.

A.4.2 Determination of the sample

Calcium type cation exchange column: Mobile phase is pure water. Connect the power of differential refraction detector in a day before the test; preheat to stable, and install the column, then adjust the temperature of column to 85 °C. Lead the mobile phase into the column at velocity of 0.1 ml/min for overnight. Before the sample solution is formally injected, input all mobile phase in a reference cell for 20 min or above. Then resume to normal flow route that the mobile phase flows through the sample cell. Adjust velocity of the mobile phase to 0.6 ml/min until the base line is stable. Then inject 5 μl –10 μl of the sample solution.

Inject the standard solutions of glucose, maltose, maltotriose, maltotetraose, maltopentaose and maltohexaose, and the test sample solution, respectively. According to retention time, qualitatively determine chromatographic peaks of different components in the sample. According to peak areas, calculate the percentage contents of components using normalization method.

Amino bonded column: Mobile phase is acetonitrile:water=67:33. Connect the power of differential refraction detector in a day before the test; preheat to stable, and install the column, then adjust the temperature of column to 75 °C. Lead the mobile phase into the column at velocity of 0.1 ml/min for overnight. Before the sample solution is formally injected, input all mobile phase in a reference cell for 20 min or above. Then resume to normal flow route that the mobile phase flows through the sample cell. Adjust velocity of the mobile phase to 1.0 ml/min until the base line is stable. Then inject 5 μl –10 μl of the sample solution.

Inject the standard solutions of glucose, maltose, isomaltose, panose, isomaltotriose, maltotriose, maltotetraose, isomaltotetrose, maltopentaose and maltohexaose, and the test sample solution, respectively. According to retention time, qualitatively determine chromatographic peaks of different components in the sample. According to peak areas, calculate the percentage contents of components using normalization method.

A.4.3 Calculation of result

A.4.3.1 For calcium type cation exchange column, the percentage content of component i of the sample in total sugar is calculated in accordance with formula (A.1):

$$DP_i = \frac{A_i}{\sum A_i} \times 100 \quad \dots\dots\dots (A.1)$$

Where:

DP_i – Percentage content of a sugar component i in total sugar, %;

A_i – Peak area of sugar component i in sample;

$\sum A_i$ – Sum of peak areas of the components in sample.

A.4.3.2 For amino bonded column, the percentage content of glucose of sample in total sugar is calculated accordance with formula (A.2):

$$G_1 = DP_1 \quad \dots\dots\dots (A.2)$$

The percentage content of isomaltose of sample in total sugar is calculated accordance with formula (A.3):

$$IG_2 = \frac{A_{IG_2}}{A_{G_2} + A_{IG_2}} \times DP_2 \quad \dots\dots\dots (A.3)$$

The percentage content of panose of sample in total sugar is calculated accordance with formula (A.4):

$$P = \frac{A_P}{A_{G_3} + A_P + A_{IG_3}} \times DP_3 \quad \dots\dots\dots (A.4)$$

The percentage content of isomaltotriose of sample in total sugar is calculated accordance with formula (A.5):

$$IG_3 = \frac{A_{IG_3}}{A_{G_3} + A_P + A_{IG_3}} \times DP_3 \quad \dots\dots\dots (A.5)$$

The percentage content of tetrasacchride or higher polymers of sample in total sugar is calculated accordance with formula (A.6):

$$G_n = 100 - DP_1 - DP_2 - DP_3 \quad \dots\dots\dots (A.6)$$

Where:

G_1 (DP_1) — Percentage content of glucose of sample in total sugar, %;

IG_2 — Percentage content of isomaltose of sample in total sugar, %;

A_{IG2} — Peak area of isomaltose in sample;

A_{G2} — Peak area of maltose in sample;

DP_2 — Percentage content of disacchrides of sample in total sugar, %;

P — Percentage content of panose of sample in total sugar, %;

A_p — Peak area of panose in sample;

A_{G3} — Peak area of maltotriose in sample;

A_{IG3} — Peak area of isomaltotriose in sample;

DP_3 — Percentage content of trisacchrides of sample in total sugar, %;

IG_3 — Percentage content of isomaltotriose of sample in total sugar, %;

G_n — Percentage content of tetrasaccharides or higher polymers of sample in total sugar, %;

The calculation results are rounded to integer.

A.4.4 Precision

The difference between the absolute values of the results of 2 separate tests under repeatable condition is not greater than 1% of mean arithmetical value.

65 of Curriculum Vitae removed in accordance with the Privacy Act of 1974.