

Impella 5.5[®] with SmartAssist[®]

For Use During Cardiogenic Shock



Instructions for Use
& Clinical Reference Manual

 **ABIOMED[®]**

IMPORTANT NOTICE: Read this entire manual before using the Automated Impella Controller and Impella Circulatory Support System (Impella System). The Impella System is to be used only in accordance with this manual. This manual is only applicable to Impella Systems using the Automated Impella Controller.

Information contained in this document is subject to change without notice.

©2020 Abiomed®, Inc. All rights reserved.

The ABIOMED logo, ABIOMED, Impella 5.5® with SmartAssist® and Recovering Hearts. Saving Lives. are registered trademarks of ABIOMED, Inc. in the U.S. and in certain foreign countries.

The following information pertains to the Emergency Use Authorization (EUA) during the Coronavirus Disease 2019 (COVID-19) outbreak granted by the FDA and does not apply to the indications approved under the PMA listed on Page 1.1:

- The Impella 5.5 with SmartAssist System has neither been cleared or approved for use by healthcare providers (HCP) in the hospital setting to provide temporary (≤ 14 days) LV unloading and support in critical care patients with confirmed Coronavirus Disease 2019 (COVID-19) infection who are undergoing extracorporeal membrane oxygenation (ECMO) treatment and who develop pulmonary edema while on veno-arterial (V-A) ECMO support or late cardiac decompensation from myocarditis while on veno-venous (V-V) ECMO support.

For purposes of this EUA, “critical care” patients refer to patients in the intensive care unit (ICU) who have confirmed COVID-19 infection.

- The Impella 5.5 with SmartAssist System has been authorized for the above emergency use by FDA under an EUA; and,
- The Impella 5.5 with SmartAssist System has been authorized for the above emergency use only for the duration of the declaration that circumstances exist justifying the authorization of the emergency use of medical devices under section 564(b)(1) of the Act, 21 U.S.C. § 360bbb-3(b)(1), unless the authorization is terminated or revoked sooner.

IMPELLA 5.5[®] WITH SMARTASSIST[®] FOR USE DURING CARDIOGENIC SHOCK INSTRUCTIONS FOR USE AND CLINICAL REFERENCE MANUAL

(UNITED STATES ONLY)

Rx Only

Abiomed, Inc.

22 Cherry Hill Drive
Danvers, MA 01923
978-646-1400 (voice)
978-774-7240 (fax)
clinical@abiomed.com (email)

Abiomed Europe GmbH

Neuenhofer Weg 3
52074 Aachen, Germany
+49 (0) 241 8860-0 (voice)
+49 (0) 241 8860-111 (fax)
europe@abiomed.com (email)

www.abiomed.com

24-Hour Clinical Support Center:

N. America 1-800-422-8666
Europe +49 (0) 1805 2246633

July 2020

Document No. 0550-9002 rC



Recovering hearts. Saving lives.

Page intentionally left blank

TABLE OF CONTENTS

Introduction.....	9	Cardiac Shock after Acute Myocardial Infarction - Summary of Primary Clinical Studies.....	6.41
1 INDICATIONS, CONTRAINDICATIONS, AND POTENTIAL ADVERSE EVENTS		Summary of Supplemental Clinical Information	6.47
Indications (United States)	1.1	Cardiac shock after open heart surgery - summary of primary clinical studies	6.58
Contraindications (United States)	1.1	Summary of Supplemental Clinical Information	6.64
Potential Adverse Events (United States)	1.1	Clinical Experience Overview for Cardiogenic Shock in the Setting of Cardiomyopathy, Myocarditis, and Peripartum Cardiomyopathy	6.74
2 WARNINGS AND CAUTIONS		7 PATIENT MANAGEMENT TOPICS	
Warnings	2.1	Patient Management Overview	7.1
Cautions	2.3	The Need for Early Identification of Cardiogenic Shock Patients.....	7.1
3 THE IMPELLA CATHETER AND AUTOMATED IMPELLA CONTROLLER		General Patient Care Considerations	7.3
Overview	3.1	Transport Within the Hospital	7.3
Impella Catheter	3.3	Right Heart Failure	7.4
Automated Impella Controller	3.5	ECG Interference.....	7.4
Purge Cassette.....	3.6	Latex.....	7.4
Accessories	3.8	Use of Echocardiography for Positioning of the Impella Catheter.....	7.4
4 USING THE AUTOMATED IMPELLA CONTROLLER		Understanding and Managing Impella Catheter Position Alarms.....	7.11
Overview	4.1	Impella Stopped	7.18
Automated Impella Controller Features.....	4.1	Suction	7.18
Home Screen.....	4.5	Hemolysis	7.18
Placement Screen.....	4.8	Enabling Purge Flow Notifications.....	7.20
Purge Screen.....	4.10	Disabling Audio Alarms.....	7.20
Infusion History Screen	4.11	Surgical Mode.....	7.20
LVEDP Trend Screen	4.12	Operating the Impella Catheter without Heparin in the Purge Solution	7.21
Mobile Operation.....	4.13	Timed Data Recording.....	7.21
5 USING THE AUTOMATED IMPELLA CONTROLLER WITH THE IMPELLA CATHETER		Operating the Impella Catheter in Electromagnetic Fields	7.21
Pre-support Evaluation	5.1	Transferring from the Automated Impella Controller to a New AIC	7.23
Startup.....	5.2	Emergency Shutdown Procedure.....	7.24
Turning on the Automated Impella Controller.....	5.3	Anti-Coagulation Therapy with Impella Heparin Infusion	7.25
Case Start.....	5.4	8 AUTOMATED IMPELLA CONTROLLER ALARMS	
Axillary Insertion of the Impella 5.5 Catheter	5.11	Alarms Overview.....	8.1
Alternate Insertion Technique Using a Sidearm Graft & Silicone Plugs.....	5.15	Alarm Message Summary.....	8.3
Direct Aortic Insertion.....	5.17	9 GENERAL SYSTEM INFORMATION	
Positioning & Starting Impella 5.5 with SmartAssist Catheter	5.19	Terminology, Abbreviations, and Symbols	9.1
Use of the Repositioning Unit.....	5.20	Automated Impella Controller Mechanical Specifications	9.3
P-Level.....	5.21	Automated Impella Controller Electrical Specifications.....	9.3
Adjusting the LV Placement Signal	5.22	Equipment Design.....	9.4
Entering Cardiac Output.....	5.24	Equipment Classifications	9.4
Purge Cassette Procedures.....	5.26	Federal Communications Commission (FCC) Notice.....	9.5
Troubleshooting the Purge System	5.29	Electromagnetic Compatibility	9.5
Patient Weaning	5.30	Use of Extracorporeal Membrane Oxygenation (ECMO) with Impella Patients in Cardiogenic Shock	9.6
Removing the Impella 5.5 with SmartAssist Catheter	5.31	Transport Between Hospitals	9.7
6 CLINICAL EXPERIENCE		VGA Monitor Connection.....	9.12
Clinical Experience Overview for HRPCI.....	6.1	Alarm Delay Information	9.13
PROTECT I Clinical Study	6.1	Patient Environment.....	9.13
PROTECT II Pivotal Clinical Study Design	6.2	Use Environment.....	9.13
Accountability of PROTECT II Cohort.....	6.6	Impella Catheter Parameters.....	9.14
Limitations of Interpretation of Study Results.....	6.7	Technical Specifications	9.15
Study Population Demographics and Baseline Characteristics	6.7	Impella 5.5 with SmartAssist Catheter Dimensions	9.15
Procedural Characteristics.....	6.10	Cleaning	9.16
Safety and Effectiveness Results	6.13	Storing the Automated Impella Controller.....	9.16
Secondary Safety Results	6.20	Returning an Impella Catheter to Abiomed (United States)	9.16
Secondary Effectiveness Results.....	6.21	APPENDICES	
Summary of Supplemental Clinical Information	6.22	Appendix A: Impella Ventricular Support Systems Limited Service Warranty (United States)	A.1
Conclusion.....	6.40	Appendix B: Automated Impella Controller Menu Structure	B.1
Clinical Experience overview for Cardiogenic Shock after Acute Myocardial Infarction or Open Heart Surgery	6.41		

TABLE OF CONTENTS

FIGURES

Figure 3.1	Impella Catheter in the Heart	3.1			
Figure 3.2	Set-up Configuration of the Automated Impella Controller, Impella 5.5 Catheter.....	3.2	Figure 6.7	In-Hospital Mortality for “All USPella HRPPI Patients,” “All USPella HRPPI Patients who met PROTECT II Criteria” and PROTECT II Patients for Both IABP and Impella 2.5 Arm....	6.24
Figure 3.3	Impella 5.5 with SmartAssist Catheter.....	3.3	Figure 6.8	Time Intervals for Impella Implants (Patient Selection) by Type of Device	6.26
Figure 3.4	Automated Impella Controller – Front View	3.5	Figure 6.9	Kaplan-Meier Curve for Freedom From Death to 30-days in HRPPI Patients Supported with Impella 2.5 or Impella CP	6.29
Figure 3.5	Purge Cassette	3.6	Figure 6.10	Time intervals for Impella Support (Patient Selection) by Type of Device	6.31
Figure 3.6	Impella Axillary Insertion Kit	3.8	Figure 6.11	Kaplan-Meier Curve for Freedom from Death to 30-days in HRPPI Patients.....	6.38
Figure 3.7	Placement Guidewire.....	3.8	Figure 6.12	Kaplan-Meier Curve for Freedom from MACCE to 30-days in HRPPI	6.39
Figure 3.8	Silicone Plugs.....	3.8	Figure 6.13	Kaplan-Meier Survival Curves Survival (to 30-days) for the ISAR-SHOCK Trial.....	6.44
Figure 3.9	Dextrose Solution	3.9	Figure 6.14	Lactate Levels Seen Post-Implant During the Trial	6.45
Figure 3.10	Automated Impella Controller Cart	3.9	Figure 6.15	Increase in Cardiac Index from Baseline, Impella vs. IABP 30 Minutes Post-Support, in Patients Treated for Cardiogenic Shock After an AMI (ISAR-SHOCK).....	6.46
Figure 4.1	Automated Impella Controller Features – Front View.....	4.1	Figure 6.16	Change in Inotropic Dosage at 24-Hours, Impella vs. IABP, in Patients Treated for Cardiogenic Shock After an AMI (ISAR-SHOCK).....	6.46
Figure 4.2	Automated Impella Controller Features – Side Views	4.3	Figure 6.17	Time Intervals for Impella Implants Data Collection by Type of Device	6.48
Figure 4.3	Home Screen with Pump Metrics enabled	4.5	Figure 6.18	Kaplan-Meier Curve Estimates for 30-day Survival – All Patient Cohort.....	6.49
Figure 4.4	Placement Screen.....	4.8	Figure 6.19	Kaplan-Meier curve Estimates, 30-day Survival (by device) – All Patient Cohort.....	6.49
Figure 4.5	Purge Screen.....	4.10	Figure 6.20	Outcomes Between Impella Registry Subgroups: Patients Likely to be Eligible for RCTs vs. Patients Likely to be Excluded from RCTs (“Salvage” Patients).....	6.50
Figure 4.6	Infusion History Screen	4.11	Figure 6.21	30-day Outcomes (By Device) Between Impella Registry Subgroups: Patients Likely to be Eligible for RCTs vs. Patients Likely to be Excluded from RCTs (“Salvage” Patients)	6.51
Figure 4.7	LVEDP Trend Screen	4.12	Figure 6.22	Survival to Discharge Outcomes (By Device) Between Impella Registry Subgroups: Patients Likely to be Eligible for RCTs vs. Patients Likely to be Excluded From RCTs (“Salvage” Patients)	6.51
Figure 5.1	Automated Impella Controller Power Switch	5.3	Figure 6.23	Kaplan-Meier Curve Estimates for 30-day Survival.....	6.52
Figure 5.2	Automated Impella Controller Startup Screen	5.4	Figure 6.24	Survival to Discharge in AMICS Cohort	6.52
Figure 5.3	Initial Case Start Screen	5.5	Figure 6.25	Improvement in Patient Hemodynamics (from Baseline to 48hrs Post Device Implant) for RECOVER I Patients.....	6.56
Figure 5.4	Inserting Purge Cassette into Automated Impella Controller	5.6	Figure 6.26	Decrease in Inotropes and Pressors (Post-Device Placement) for RECOVER I Patients	6.56
Figure 5.5	Connecting Impella Catheter	5.7	Figure 6.27	RECOVER I Enrollment	6.60
Figure 5.6	Connecting Luer and priming Impella Catheter	5.7	Figure 6.28	Kaplan-Meier Survival Curve for Freedom from Death (to 1 Year).....	6.62
Figure 5.7	Connecting the luer to the Impella Catheter.....	5.8	Figure 6.29	Time Intervals for Impella Implants Data Collection by Type of Device	6.64
Figure 5.8	Snapping Purge Clip to Connector Cable	5.8	Figure 6.30	Kaplan-Meier Curve Estimates for 30-day Survival – All Patients Cohort	6.65
Figure 5.9	Entering Purge Fluid Information.....	5.9	Figure 6.31	Kaplan-Meier Curve Estimates for 30-day Survival – For Different Devices	6.65
Figure 5.10	Changing the Purge Fluid Information.....	5.10	Figure 6.32	Groups Used for Each Classification Analysis	6.66
Figure 5.11	Connecting the Purge Tubing to the Connector Cable.....	5.10	Figure 6.33	Kaplan-Meier Curve for 30-day Survival Using Classification A (All Patients)	6.66
Figure 5.12	Introducer, Graft Lock, and Hemashield Platinum Graft (Graft Not Supplied).....	5.12	Figure 6.34	Kaplan-Meier Curve for 30-day Survival Using Classification A (Patients with Impella 5.0/Impella LD).....	6.67
Figure 5.13	Correct Positioning if Second Graft Lock Required	5.12	Figure 6.35	Kaplan-Meier Curve for 30-day Survival Using Classification A (Patients with Impella CP).....	6.67
Figure 5.14	Closing the Graft Lock	5.13	Figure 6.36	Kaplan-Meier Curve for 30-day Survival Using Classification A (Patients with Impella 2.5)	6.67
Figure 5.15	Releasing the Graft Lock.....	5.14			
Figure 5.16	Removing the Peel-Away Introducer	5.14			
Figure 5.17	Axillary Artery Insertion of the Impella 5.5 Catheter Using a Sidearm Graft	5.15			
Figure 5.18	Impella 5.5 Catheter with Silicone Plugs	5.17			
Figure 5.19	Starting the Impella 5.5 SmartAssist Catheter.....	5.19			
Figure 5.20	Adjusting P-level.....	5.21			
Figure 5.21	Adjust LV white notification	5.22			
Figure 5.22	Pump Metrics IFU post-calibration in LV adjust tool	5.23			
Figure 5.23	Pump Metrics IFU post-calibration placement screen	5.23			
Figure 5.24	Pump Metrics IFU Enter Cardiac Output tool.....	5.24			
Figure 5.25	Pump Metrics IFU Yellow CPO.....	5.25			
Figure 5.26	Disconnecting the Y Connector from the Purge Cassette Tubing.....	5.26			
Figure 5.27	Air Detected Alert.....	5.28			
Figure 6.1	PROTECT II Study Schematic	6.5			
Figure 6.2	Study Flow Schematic	6.6			
Figure 6.3	Kaplan-Meier Curves for Major Adverse Events (Intent-to-Treat Population).....	6.15			
Figure 6.4	Kaplan-Meier Curves for Major Adverse Events (Per-Protocol Population).....	6.15			
Figure 6.5	Additional Analysis of the Composite MAE and MACCE Rates in the Per-Protocol Population Using a Meaningful, Contemporary Definition for Peri-Procedural MI (8x ULN)	6.24			
Figure 6.6	Additional Analysis of the Composite MAE and MACCE Rates in the Intent-to-Treat Population Using a Meaningful, Contemporary Definition for Peri-Procedural MI (8x ULN)	6.24			

TABLE OF CONTENTS

Figure 6.37	Kaplan-Meier Curve for 30-day Survival Using Classification B (All Patients)	6.68
Figure 6.38	Kaplan-Meier Curve for 30-day Survival Using Classification B (Patients with Impella 5.0/Impella LD)	6.68
Figure 6.39	Kaplan-Meier Curve for 30-day Survival Using Classification B (Patients with Impella CP)	6.68
Figure 6.40	Kaplan-Meier Curve for 30-day Survival Using Classification B (Patients with Impella 2.5)	6.69
Figure 6.41	Flow Diagram of the Distribution of the AB5000 LVAD PCCS Patient Cohort	6.70
Figure 6.42	Kaplan-Meier Curve Estimates for 30-day Survival	6.70
Figure 6.43	Improvement in Patient Hemodynamics (from Baseline to 48 hr Post-Device Implant) for RECOVER I Patients	6.72
Figure 6.44	Decrease in Inotropes and Pressors (Post-Device Placement) for RECOVER I Patients	6.73
Figure 6.45	Time Intervals for Impella Implants Data Collection by Type of Device	6.75
Figure 6.46	Survival to Discharge (A) and Patient Status at Discharge (B) – All Patients (N=93)	6.78
Figure 6.47	Survival to discharge (A) and patient status at discharge (B) – Cardiomyopathy patients (N=50)	6.79
Figure 6.48	Survival to Discharge (A) and Patient Status at Discharge (B) – Myocarditis Patients (N=34)	6.80
Figure 6.49	Survival to Discharge (A) and Patient Status at Discharge (B) – PPCM Patients (N=9)	6.80
Figure 6.50	Kaplan-Meier Curve Estimates for 30-day Survival – All Patients (N=93)	6.84
Figure 6.51	Kaplan-Meier curve estimates for 30-day Survival – cardiomyopathy patients (N=50)	6.85
Figure 6.52	Kaplan-Meier Curve Estimates for 30-day Survival – Myocarditis Patients (N=34)	6.85
Figure 6.53	Kaplan-Meier Curve Estimates for 30-day Survival – PPCM Patients (N=9)	6.85
Figure 6.54	Survival Comparisons of Impella Registry Data, Impella Literature, and Other MCS Reviewed in Literature Review	6.88
Figure 7.1	Labeled TEE and TTE Images of the Impella Catheter Position ..	7.5
Figure 7.2	Transesophageal Echocardiographic (TEE) Illustrations of Impella Catheter Position	7.8
Figure 7.3	Transthoracic Echocardiographic (TTE) Illustrations of Impella Catheter Position	7.9
Figure 7.4	Correct and Incorrect Impella Catheter Position (Color Doppler TTE)	7.10
Figure 7.5	Correct Impella 5.5 Catheter Position	7.12
Figure 7.6	Impella 5.5 with SmartAssist Catheter Position in Ventricle ..	7.12
Figure 7.7	Loosen the Tuohy-borst Valve	7.13
Figure 7.8	Pulling Catheter Back Until Waveform Shifts to Aortic	7.14
Figure 7.9	Pulling Catheter Additional 3 cm	7.14
Figure 7.10	Tightening Tuohy-borst Valve	7.15
Figure 7.11	Repositioning Complete	7.15
Figure 7.12	Impella 5.5 with SmartAssist Position in Aorta	7.16
Figure 7.13	Impella 5.5 with SmartAssist Catheter Position Unknown	7.17
Figure 8.1	Alarm Window	8.2
Figure 9.1	Automated Impella Controller Patient Environment	9.13
Figure 9.2	Impella 5.5 with SmartAssist Catheter Dimensions	9.15

TABLES

Table 3.1	Impella Axillary Insertion Kit	3.2
Table 3.2	Impella Catheter Components	3.4
Table 3.3	Purge Cassette Components	3.7
Table 3.4	Impella Catheter and Automated Impella Controller Accessories	3.8
Table 4.1	Automated Impella Controller Front View Features	4.2
Table 4.2	Automated Impella Controller Side View Features	4.4
Table 4.3	Automated Impella Controller Display Elements	4.7
	(continued on)	4.8
Table 5.1	Evaluation Prior to Inserting the Impella Catheter	5.1
Table 5.2	P-level Flow Rates for the Impella 5.5 with SmartAssist Catheter	5.21
Table 6.1	Summary of Primary Clinical Studies Reviewed by the FDA (Prior to Approval)	6.1
Table 6.2	Patient Baseline Characteristics (ITT Population)	6.8
Table 6.3	Procedural Characteristics	6.11
	(continued on)	6.12
Table 6.4a	Composite MAE at 30 Days and 90 Days (Intent-to-Treat Population)	6.14
Table 6.4b	Composite MAE at 30 Days and 90 Days (Per-Protocol Population)	6.14
Table 6.5a	Subgroup Without Impella Roll-In Subject (Intent-to-Treat Population)	6.16
Table 6.5b	Subgroup Without Impella Roll-In Subject (Per-Protocol Population)	6.16
Table 6.6a	Subgroup Without Rotational Atherectomy (Intent-to-Treat Population)	6.16
Table 6.6b	Subgroup Without Rotational Atherectomy (Per-Protocol Population)	6.16
Table 6.7a	Subgroup With Rotational Atherectomy (Intent-to-Treat Population)	6.17
Table 6.7b	Subgroup With Rotational Atherectomy (Per-Protocol Population)	6.17
Table 6.8a	Subgroup of Unprotected Left Main / Last Patent Conduit (Intent-to-Treat Population)	6.17
Table 6.8b	Subgroup of Unprotected Left Main / Last Patent Conduit (Per-Protocol Population)	6.18
Table 6.9a	Subgroup of Three Vessel Disease (Intent-to-Treat Population)	6.18
Table 6.9b	Subgroup of Three Vessel Disease (Per-Protocol Population)	6.18
Table 6.10a	Subgroup of STS Mortality Score <10 (Intent-to-Treat Population)	6.19
Table 6.10b	Subgroup of STS Mortality Score <10 (Per-Protocol Population)	6.19
Table 6.11a	Subgroup of STS Mortality Score ≥10 (Intent-to-Treat Population)	6.19
Table 6.11b	Subgroup of STS Mortality Score ≥10 (Per-Protocol Population)	6.19
Table 6.12a	Individual MAE Components (ITT Population) Non-Hierarchical	6.20
Table 6.12b	Individual MAE Components (PP Population) Non-Hierarchical	6.21
Table 6.13a	Composite MAE at 30 and 90 Days Using Contemporary Definition for Peri-Procedural MI (8x ULN) (Intent-to-Treat Population and Per-Protocol Population)	6.22
Table 6.13b	Composite MACCE at 30 and 90 Days Using Contemporary Definition for Peri-Procedural MI (8x ULN) (Intent-to-Treat Population and Per-Protocol Population)	6.23
Table 6.14	In-Hospital Site-Reported AEs for HRPIC Patients Supported with Impella 2.5 or Impella CP in Impella Registry	6.28
Table 6.15	Causes of In-Hospital Deaths for HRPIC Patients Supported with Impella 2.5 or Impella CP® in Impella Registry	6.30

TABLE OF CONTENTS

TABLES, CONTINUED

Table 6.16	Clinical Evidence to Support the Impella 2.5 and Impella CP Devices for HRPCL.....	6.30	Table 9.1	Terminology and Abbreviations.....	9.1
Table 6.17	Patient Demographics and Baseline Characteristics (continued on)	6.33 6.34	Table 9.2	Symbols	9.1
Table 6.18	Patient Admission, Procedural and Support Characteristics (continued on)	6.35 6.36	Table 9.2	Symbols (continued).....	9.2
Table 6.19	In-Hospital Site-reported Adverse Events	6.37	Table 9.3	Mechanical Specifications for the Automated Impella Controller	9.3
Table 6.20	Baseline Demographics and Characteristics	6.43	Table 9.4	Electrical Specifications for the Automated Impella Controller..	9.3
Table 6.21	Baseline Hemodynamics	6.44	Table 9.5	Equipment Classifications	9.4
Table 6.22	Adverse Events Monitoring	6.45	Table 9.6	Guidance and Manufacturer’s Declaration - Emissions, All Equipment and Systems	9.8
Table 6.23	Site-Reported Adverse Events (to Discharge) by Classification..	6.54	Table 9.6	Guidance and Manufacturer’s Declaration - Immunity.....	9.9
Table 6.24	Baseline Patient Characteristics	6.60	Table 9.7	Guidance and Manufacturer’s Declaration - Emissions, Equipment and System that are life-supporting.....	9.10
	(continued on)	6.61	Table 9.8	Guidance and Manufacturer’s Declaration - Immunity.....	9.9
Table 6.25	Baseline Patient Hemodynamics.....	6.61	Table 9.8	Guidance and Manufacturer’s Declaration - Emissions, Equipment and System that are life-supporting.....	9.10
	(continued on)	6.62	Table 9.9	Recommended Separation Distances Between Portable and Mobile RF Communications Equipment and the Automated Impella Controller, Equipment and Systems that are Life-Supporting.....	9.11
Table 6.26	Site-reported adverse events (to discharge) by classification ...	6.71	Table 9.10	RFID Transmitter / Receiver Specifications	9.11
Table 6.27	Demographics and Baseline Characteristics	6.76	Table 9.11	Impella Connect Wi-Fi Transmitter / Receiver Specifications.....	9.11
Table 6.28	Baseline Hemodynamics	6.77	Table 9.12	Alarm Delay Information	9.13
Table 6.29	Impella support characteristics	6.77	Table 9.13	Impella 5.5 with SmartAssist Catheter Parameters.....	9.14
Table 6.30	Comparison of Hemodynamics Pre-Support and on-Support (Paired Data)	6.81	Table 9.14	Impella 5.5 with SmartAssist Pump Metrics	9.15
Table 6.31	Site-Reported Adverse Events (to Discharge).....	6.82			
Table 6.32	Causes of In-Hospital Death	6.83			
Table 6.33	In-Hospital Deaths CEC-Adjudicated as Related to the Device.....	6.84			
Table 6.34	In-hospital Deaths CEC-Adjudicated as Related to the Procedure	6.84			
Table 6.35	Site-reported AEs to Discharge from Global cVAD Registry Analysis.....	6.89			
Table 7.1	Clinical Society Guidelines for Impella Therapy.....	7.2			
Table 7.2	Guide for Managing Hemolysis in Various Circumstances.....	7.19			
Table 7.3	Troubleshooting When Operating the Impella Catheter in the Presence of a EAM System	7.22			
Table 7.4	Troubleshooting When Operating the Impella Catheter in the Presence of a MNS System	7.23			
Table 7.5	Clinical scenarios for anti-coagulation therapy with the Impella purge system heparin (50 U/mL).....	7.26			
Table 7.6	Patient scenarios for anti-coagulation therapy with the Impella purge system heparin (25 U/mL).....	7.27			
Table 8.1	Alarm Levels	8.1			
Table 8.2	Automated Impella Controller Alarm Messages..	8.3			
	(continued on)	8.7			

INTRODUCTION

PURPOSE OF MANUAL

This Instructions for Use and Clinical Reference Manual is designed for healthcare professionals. It contains clinical and technical information to guide healthcare professionals in their use of the Impella 5.5 Catheter to treat cardiogenic shock. To use the system you must understand and follow these instructions. The Impella 5.5 may be used only for its intended purpose.

MANUAL OVERVIEW

This manual provides instructions for use of the Impella 5.5 Catheter with the Automated Impella Controller. The following summarizes the contents of each section of the manual.

- **Section 1: Indications, Contraindications, and Potential Adverse Events** discusses indications for use of the Impella Catheter with the Automated Impella Controller, contraindications, and potential adverse events that may be associated with the use of the system.
- **Section 2: Warnings and Cautions** discusses the warnings and cautions pertaining to the use of the Impella Catheter with the Automated Impella Controller.
- **Section 3: The Impella Catheter and Automated Impella Controller** provides an overview of the system and describes its major components and features.
- **Section 4: Using the Automated Impella Controller** describes the controls and various screen types on the Automated Impella Controller.
- **Section 5: Using the Automated Impella Controller with the Impella Catheter** provides the procedures for using the Impella Ventricular Support Systems.
- **Section 6: High-Risk PCI Clinical Experience** provides an overview of clinical studies of the Impella 2.5[®] and Impella CP[®] for use in HRPCI. **Cardiogenic Shock Clinical Experience** provides an overview of clinical studies of the Impella 2.5, Impella CP, Impella 5.0, and Impella LD for use in cardiogenic shock.
- **Section 7: Patient Management Topics** provides key information on various topics related to management of patients with the Impella Catheter and Automated Impella Controller.
- **Section 8: Automated Impella Controller Alarms** provides a listing of Automated Impella Controller alarms as well as information on what to do to resolve them.
- **Section 9: General System Information** contains information including definitions for key terms that appear in the manual, descriptions of the abbreviations and symbols that appear on Impella Catheter and Automated Impella Controller components and packaging, technical information pertaining to the Impella Catheter and Automated Impella Controller, and instructions on cleaning and storing system components as well as returning components to Abiomed.
- **Appendices** at the end of the manual provide supplemental information about topics including the Impella Limited Service Warranty, and the Automated Impella Controller menu structure.

Page intentionally left blank

1 INDICATIONS, CONTRAINDICATIONS, AND POTENTIAL ADVERSE EVENTS



INTRODUCTION	11
Purpose of Manual	11
Manual Overview	11
INDICATIONS (UNITED STATES)	1.1
PMA Approved Indication.....	1.1
Emergency Use Authorization	1.1
CONTRAINDICATIONS (UNITED STATES).....	1.1
POTENTIAL ADVERSE EVENTS (UNITED STATES)	1.1

Page intentionally left blank

INDICATIONS (UNITED STATES)

PMA APPROVED INDICATION

Cardiogenic Shock

The Impella 5.5[®] with SmartAssist[®] System is a temporary ventricular support device intended for short term (14 days) use and indicated for the treatment of ongoing cardiogenic shock that occurs immediately (< 48 hours) following acute myocardial infarction or open heart surgery or in the setting of cardiomyopathy, including peripartum cardiomyopathy, or myocarditis as a result of isolated left ventricular failure that is not responsive to optimal medical management and conventional treatment measures (including volume loading and use of pressors and inotropes, with or without IABP). The intent of Impella System Therapy is to reduce ventricular work and to provide the circulatory support necessary to allow heart recovery and early assessment of residual myocardial function.

EMERGENCY USE AUTHORIZATION

The Impella 5.5 with SmartAssist System is authorized to be used by healthcare providers (HCP) in the hospital setting to provide temporary (\leq 14 days) LV unloading and support in critical care patients with confirmed Coronavirus Disease 2019 (COVID-19) infection who are undergoing extracorporeal membrane oxygenation (ECMO) treatment and who develop pulmonary edema while on veno-arterial (V-A) ECMO support or late cardiac decompensation from myocarditis while on veno-venous (V-V) ECMO support.

For purposes of this EUA, “critical care” patients refer to patients in the intensive care unit (ICU) who have confirmed COVID-19 infection.

CONTRAINDICATIONS (UNITED STATES)

The Impella 5.5[®] with SmartAssist[®] Catheter is contraindicated for use with patients experiencing any of the following conditions: Mural thrombus in the left ventricle; Presence of a mechanical aortic valve or heart constrictive device; Aortic valve stenosis/calcification (equivalent to an orifice area of 0.6 cm² or less); Moderate to severe aortic insufficiency (echocardiographic assessment graded as \geq +2); Severe arterial disease precluding placement of the Impella System; Presence of an Atrial or Ventricular Septal Defect (including post-infarct VSD); Significant right heart failure^{*^}; Left ventricular rupture^{*^}; Cardiac tamponade^{*^}; Combined cardiorespiratory failure^{*}.

Those with an asterisks (*) apply to the cardiogenic shock indication. Those with a caret (^) apply to the COVID-19 EUA indication.

POTENTIAL ADVERSE EVENTS (UNITED STATES)

Acute renal dysfunction, Aortic valve injury, Bleeding, Cardiogenic shock, Cerebral vascular accident/Stroke, Death, Hemolysis, Limb ischemia, Myocardial infarction, Renal failure, Thrombocytopenia and Vascular injury

In addition to the risks above, there are other **WARNINGS** and **PRECAUTIONS** associated with Impella devices. To learn more, visit:

<https://www.abiomed.com/important-safety-information>.

Page intentionally left blank

2 WARNINGS AND CAUTIONS

WARNINGS2.1

CAUTIONS 2.3

Page intentionally left blank

WARNINGS

Warnings alert you to situations that can cause death or serious injury. The red symbol  appears before warning messages.



Use of the Impella Ventricular Support Systems by trained and experienced practitioners has been associated with improved outcomes. Consequently, the first use of Impella should be preceded by the completion of a contemporary Abiomed Impella training program and include on-site proctoring during the first use by Abiomed clinical support personnel certified in the use of Impella.



Institution of circulatory support using Impella has not been studied in the following conditions:

- Presence of irreversible end-organ failure
- Presence of severe anoxic brain injury



Fluoroscopy is required to guide placement of the Impella Catheter and, for the Impella 5.5[®] with SmartAssist[®] during rewire through the guidewire access port. The 0.018" placement guidewire must be reliably observed at all times.



Be sure that the stopcock on the peel-away introducer or repositioning sheath is always kept in the closed position. Significant bleed back can result if the stopcock is open.



Avoid manual compression of the inlet and outlet areas of the cannula assembly.



The sterile components of the Impella Ventricular Support Systems can be used only if the sterilization indicators show that the contents have been sterilized, the packaging is not damaged, and the expiration date has not elapsed.



Do **NOT** resterilize or reuse the Impella Catheter. It is a disposable device and is intended for single-use only. Reuse, reprocessing, or resterilization may compromise the structural integrity of the catheter and/or lead to catheter failure which, in turn, may result in patient injury, illness, or death.



Retrograde flow will occur across the aortic valve if the flow rate of the Impella Catheter is less than 0.5 L/min.



To prevent malfunction of the locking mechanism of the peel-away introducer, do **NOT** hold the hemostatic valve while inserting into the artery.



To prevent failure of the peel-away introducer, remove the peel-away introducer prior to transport when activated clotting time (ACT) is less than 150 seconds.



Do **NOT** use saline in the purge system.



Do **NOT** use an Impella Ventricular Support Systems if any part of the system is damaged.



To prevent the risk of explosion, do **NOT** operate the Impella Ventricular Support Systems near flammable anesthetics.



If at any time during the course of support with the Impella Catheter, the Automated Impella Controller™ alarms "Purge Pressure Low" or "Purge System Open," follow the instructions presented in section 5 of this manual.



MR Unsafe - Do **NOT** subject a patient who has been implanted with an Impella



System to magnetic resonance imaging (MRI). The strong magnetic energy produced by an MRI machine may cause the Impella System components to stop working, and result in injuries to the patient. An MRI may also damage the Impella System electronics.



Do not transport an Impella patient via commercial aircraft. Loss of support may occur aboard a commercial aircraft due to exposure to radiofrequency (RF) disturbances above the compliance level (<20 V/m) of the Automated Impella Controller.



Portable RF communications equipment (including peripherals such as antenna cables and external antennas) should be used no closer than 30 cm (12 inches) to any part of the Impella System, including cables specified by Abiomed. Otherwise, degradation of the performance of this equipment could result.



Cardiopulmonary support (CPR) should be initiated immediately per hospital protocol if indicated for any patient supported by the Impella Catheter. When initiating CPR, reduce the Impella Catheter flow rate. When cardiac function has been restored, return flow rate to the previous level and assess placement signals on the controller.



During defibrillation, do **NOT** touch the Impella Catheter, cables, or Automated Impella Controller.



Power the Automated Impella Controller using its internal battery if the integrity of the protective earth conductor is questionable.



Lithium-ion battery replacement by inadequately trained personnel could result in excessive temperatures, fire, or explosion. Only technicians authorized by Abiomed should remove or change the battery.



To avoid risk of electric shock, this equipment must only be connected to a supply mains with protective earth.



No modification of this equipment is allowed.



Medical electrical equipment needs special precautions regarding EMC and needs to be installed and put into service according to the electromagnetic compatibility (EMC) information provided in section 9 of this manual.



The Automated Impella Controller (AIC) performs as intended when exposed to radiofrequency (RF) disturbances below 20 V/m. During transport, the AIC may be exposed to RF disturbances above 20 V/m, which could cause minor problems, such as intermittent displays of soft button menu selections, which have no effect on the operating parameters of the Impella support system, and will resolve readily once the disturbance ends. It could also potentially result in loss of support. Patients must be closely monitored at all times during transport.



Portable and mobile RF communications equipment can affect medical electrical equipment.



The equipment or system should not be used adjacent to or stacked with other equipment. If adjacent or stacked use is necessary, the equipment or system should be observed to verify normal operation in the configuration in which it will be used.



Use of cables, other than those sold by Abiomed, may result in increased emissions or decreased immunity of the Automated Impella Controller.



The Automated Impella Controller uses RFID (radio frequency identification) to identify and communicate with the purge cassette. Other equipment may interfere with the Automated Impella Controller even if that other equipment complies with CISPR emission requirements.



Infusion through the sideport of the introducer can be done only after all air is removed from the introducer. If performed, the infusion should be done for flushing purposes only and **NOT** for delivering therapy or monitoring blood pressure.



Do **NOT** use the guidewire access port on the Impella 5.5[®] with SmartAssist[®] as an arterial line. The stylet should remain in place until guidewire access is required through the Impella Catheter.

CAUTIONS

Caution indicates situations in which equipment may malfunction, be damaged, or cease to operate. The yellow symbol  appears before caution messages.



Handle with care. The Impella Catheter can be damaged during removal from packaging, preparation, insertion, and removal. Do **NOT** bend, pull, or place excess pressure on the catheter or mechanical components at any time.



Inspect the Impella Set packaging while opening. In the event that any key components, including its end seal labels, are damaged excessively during shipment, the use of a backup Impella Set should be considered.



Physicians should exercise special care when inserting the Impella Catheter during active Cardiopulmonary Resuscitation (CPR). In addition, active CPR maneuvers may change the position of the Impella device. Check that the pump is positioned correctly in the left ventricle after CPR with echocardiography guidance.



Patients with aortic stenosis or other abnormal aortic valve performance may be compromised by the use of the Impella Catheter. Patients with aortic valve disease should be observed for aortic insufficiency.



Partial circulatory support with Impella has been associated with more extensive use of rotational atherectomy. Extensive use of rotational atherectomy has been associated with a periprocedural increase in cardiac biomarkers indicative of myocardial injury. Rotational atherectomy, with or without the use of hemodynamic support, should be used in accordance with the manufacturer's instructions for use.



Physicians should exercise special care when inserting the Impella Catheter in patients with known or suspected unrepaired abdominal aortic aneurysm or significant descending thoracic aortic aneurysm or dissection of the ascending, transverse, or descending aorta.



Use only original accessories and replacement parts supplied by Abiomed.



Do **NOT** use damaged or contaminated connector cables.



To prevent device failure, do **NOT** start the Impella Catheter until the guidewire has been removed.



Do **NOT** remove the Impella Catheter over the length of the guidewire.



When replacing the purge cassette, the replacement process should be completed within 90 Seconds of luer disconnection. The Impella Catheter may be damaged if replacement takes longer than 90 Seconds after luer disconnection.



To prevent malfunction of the Automated Impella Controller™, avoid long-term exposure to direct sunlight and excessive heat (40°C).



To prevent overheating and improper operation, do **NOT** block the cooling vents of the Automated Impella Controller while it is operating.



Do **NOT** kink or clamp the Impella Catheter with anything other than a soft jaw vascular clamp. Do **NOT** kink or clamp the peel-away introducer.



If included, during case start, make sure the yellow luer connection between the purge tubing and Y connector is tightened and not leaking.



The Li-Ion batteries must be charged for 5 hours prior to system operation in order to meet the runtime requirement of 1 hour. Failure to do so will yield a shorter runtime. After being unplugged, the Automated Impella Controller will operate for at least 60 minutes after the batteries have been fully charged.



Do not insert any unauthorized devices into the USB port. This includes chargers, memory sticks, wireless dongles and other unauthorized devices.



Minimize exposure of Impella Ventricular Support Systems components to sources of electromagnetic interference (EMI). Exposure to sources of EMI, such as cell phones and two-way radios, may cause operational interference. To clear interference, either increase the distance between system components and the EMI source or turn off the EMI source.



During use with the Impella Connect, a Medical Device Data System (MDDS), if the Automated Impella Controller is exposed to strong electromagnetic disturbances, the Impella Connect may either restart or shut down. Operators should be aware that, under these conditions, the Automated Impella Controller operating parameters are not affected.



Operation of Impella Ventricular Support Systems components may interfere with the operation of other devices. If interference occurs, increase the distance between the device and system components.



Have a backup Automated Impella Controller, purge cassette, connector cable, and Impella Catheter available in the unlikely event of a device failure.



Do **NOT** use the bed mount as a handle.



Do **NOT** alter the Impella Introducer kit in any way.



Aspiration and saline flushing of the Impella Introducer kit sheath, dilator, and valve should be performed to help minimize the potential for air embolism and clot formation.



Indwelling introducer sheaths should be internally supported by a catheter or dilator.



Dilators and catheters should be removed slowly from the sheath. Rapid removal may damage the valve, resulting in blood flow through the valve.



Never advance the guidewire or sheath when resistance is met. Determine the cause of resistance using fluoroscopy and take remedial action.



When injecting or aspirating through the sheath, use the sideport only.



Operation of the system without heparin in the purge solution has not been tested. In the event that a patient is intolerant to heparin, due to heparin-induced thrombocytopenia or bleeding, physicians should use their clinical judgment to assess the risks versus benefits of operating the Impella Ventricular Support Systems without heparin. If it is in the best interest of the patient to operate the system without heparin, the dextrose solution is still required, and physicians should consider systemic delivery of an alternative anticoagulant. The Impella Catheter has not been tested with any alternative anticoagulants in the purge solution. Use of alternative anticoagulants may reduce the longevity or performance of the Impella catheter.



Impella is compatible with High Frequency surgical equipment. However, when using HF surgical equipment, the Impella cannot come in contact with the surgical equipment.



Keep patient cable away from power cables and other high-voltage signal cables.



LVP metrics derived from Impella pump signals are not valid surrogates for monitoring the overall clinical status of the patient and should be used for informational purposes only. Refer to the Technical Specifications for details on the accuracy of these metrics.



LVP metrics displayed are not intended for diagnostic use. All parameters displayed must be verified independently using either a cleared or approved diagnostic device, and must not be used for patient monitoring.



If Extra-corporeal Membrane Oxygenation (ECMO) is to be initiated in a cardiogenic shock patient currently being treated with Impella, the benefits and risks of continuing Impella therapy for left ventricle unloading during ECMO support should be considered.

Page intentionally left blank

3 THE IMPELLA CATHETER AND AUTOMATED IMPELLA CONTROLLER™

OVERVIEW	3.1
Reusable System Components	3.1
Single-use System Components	3.2
Impella Axillary Insertion Kit	3.2
System Configurations	3.2
IMPELLA CATHETER	3.3
AUTOMATED IMPELLA CONTROLLER	3.5
PURGE CASSETTE	3.6
ACCESSORIES	3.8

OVERVIEW

The Impella Catheter is an intravascular microaxial blood pump that supports a patient's circulatory system. The Impella 5.5 Catheter is inserted via surgical cut-down through the axillary artery and into the left ventricle.

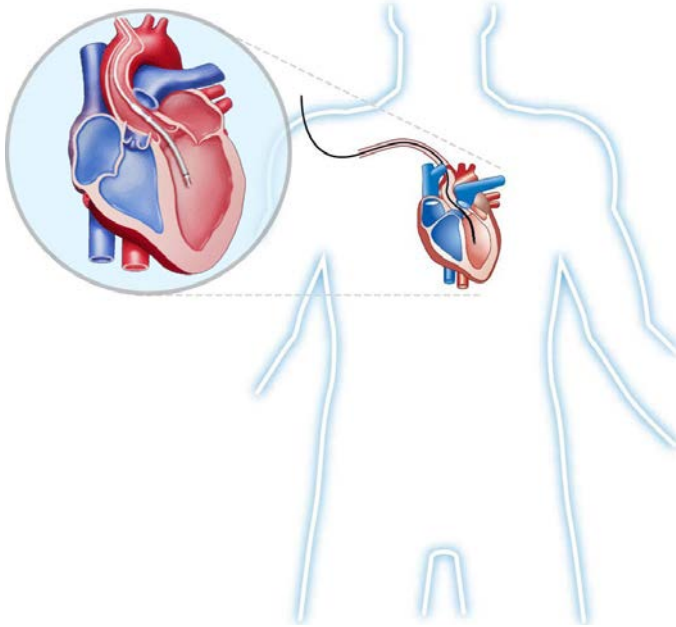

Figure 3.1 Impella Catheter in the Heart

When properly positioned, the Impella Catheter delivers blood from the inlet area, which sits inside the left ventricle, through the cannula, to the outlet opening in the ascending aorta. Physicians and device operators monitor the correct positioning and functioning of the Impella Catheter on the display screen of the Automated Impella Controller.

This section describes the components of the Impella Catheter and the Automated Impella Controller, as well as the accessory components.

REUSABLE SYSTEM COMPONENTS

The Impella Ventricular Support Systems consist of the following reusable components:

- Automated Impella Controller—provides the user interface, alarm indications, and portable battery
- Automated Impella Controller cart—for easy transport of the Automated Impella Controller

SINGLE-USE SYSTEM COMPONENTS

The Impella Ventricular Support Systems also include the following single-use components:

- Impella Catheter
- Purge cassette
- 0.018 inch, 260 cm placement guidewire
- Impella Axillary Insertion kit
- Silicone Plugs

IMPELLA AXILLARY INSERTION KIT

Table 3.1 describes the contents of the Impella Axillary Insertion kit.

Table 3.1 Impella Axillary Insertion Kit

The Impella Axillary Insertion kit contains the following:

- 23 Fr diameter x 6 cm length peel-away introducer
- 2 graft locks used to attach a graft onto the introducer (*Note: Only one graft lock is required when used with the recommended Hemashield Platinum graft; a backup is provided.*)
- 8 Fr silicone-coated lubrication dilator

It is recommended that the Impella Axillary Insertion kit be used in conjunction with a 10 mm diameter x 20 cm length Hemashield Platinum graft

SYSTEM CONFIGURATIONS

System configuration for Impella 5.5

Figure 3.2 illustrates how the Automated Impella Controller connects to the Impella 5.5 Catheter and accessory components in the initial set-up configuration.

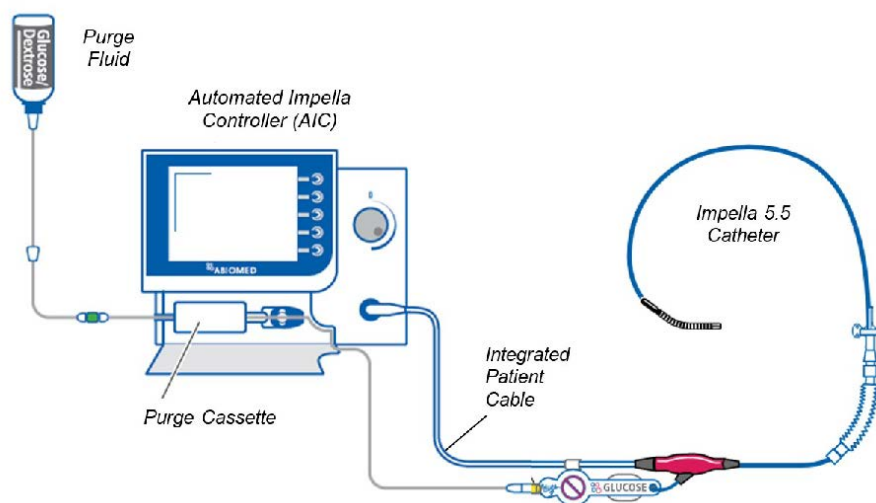

Figure 3.2 Set-up Configuration of the Automated Impella Controller, Impella 5.5 Catheter

Discard the Y-Connector

If included, after opening the purge cassette package, disconnect and discard the Y-connector.

IMPELLA CATHETER

The Impella Catheter is an intravascular microaxial blood pump that delivers up to a maximum mean of 5.5 liters of blood per minute from the left ventricle into the aorta. Figure 3.3 illustrates the Impella Catheters. Table 3.2 describes each component from the inlet area at one end to the check valve on the other end.

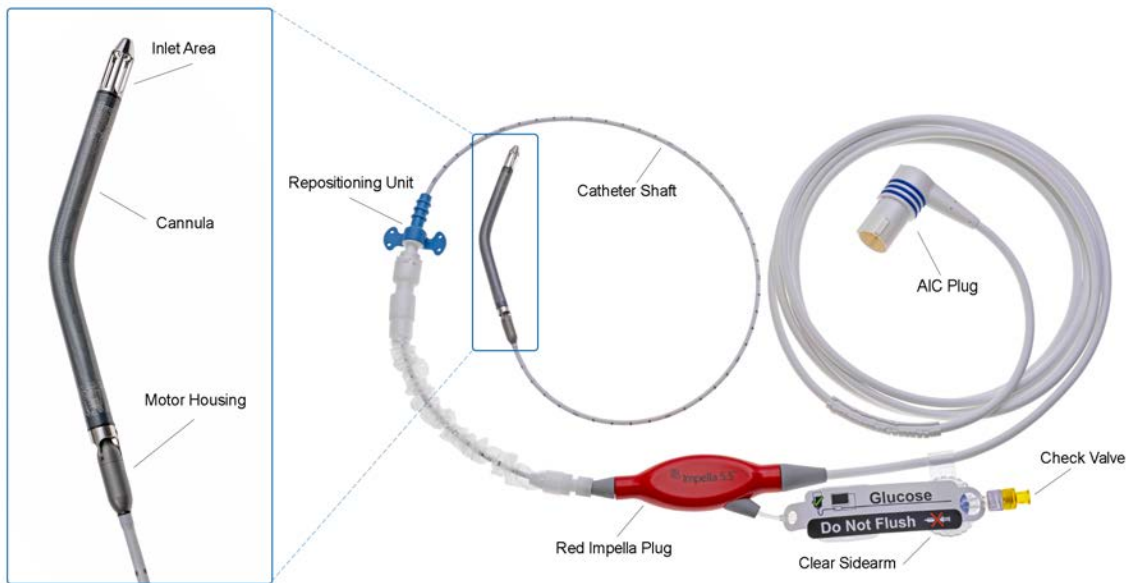

Figure 3.3 *Impella 5.5 with SmartAssist Catheter*

Table 3.2 Impella Catheter Components

Component	Description
Inlet area	The inlet area, located at the distal tip of the cannula, has five openings (windows) that allow blood to be drawn into the inlet and channeled through the cannula.
Cannula	The cannula (21 Fr for the Impella 5.5) has a spiral-shaped reinforced body that is angled for the Impella 5.5 Catheter. The cannula is made of nitinol and covered in polyurethane.
Outlet area	The proximal end of the cannula is attached to the outlet area where the blood exits the cannula.
Motor housing	The motor housing 19 Fr for Impella 5.5 with SmartAssist consists of an encapsulated motor.
Fiber-optic sensor	This sensor on the Impella 5.5 with SmartAssist is located at the distal end of the outlet area. This sensor is used to monitor positioning during placement and catheter operation.
Catheter shaft	A 9 Fr catheter shaft is located between the motor housing and the red Impella plug. The lumen of the catheter shaft contains a purge lumen, a stainless steel coil, a fiber-optic cable, and an electrical cable. The catheter shaft has longitudinal and transversal marks: <ul style="list-style-type: none">• The longitudinal mark along the inner radius shows correct position of the placement guidewire once backloaded on the Impella Catheter.• The transversal marks at 1 cm intervals with numbers every 5 cm aid in proper positioning.
Repositioning unit	The repositioning unit on the Impella 5.5 Catheter consists of an anticontamination sleeve with an anchoring ring, and suture pads. <ul style="list-style-type: none">• The anchoring ring of the anticontamination sleeve secures the sheath to the catheter.• The StatLock® compatible suture pads help secure the repositioning sheath to the patient's skin.
Red Impella plug	The red Impella plug at the proximal end of the catheter connects the catheter to the Automated Impella Controller through a connector cable. It contains: <ul style="list-style-type: none">• Memory that retains operating parameters in case the patient needs to be transferred to another controller The Impella 5.5 Catheter has only a clear sidearm.
Clear sidearm	The clear sidearm is attached to the purge cassette tubing. It leads to the infusion filter, the pressure reservoir, and the check valve.
Infusion filter	The infusion filter prevents bacterial contamination and air from entering the purge lumen.
Pressure reservoir	The pressure reservoir includes a flexible rubber diaphragm that provides additional filling volume by means of an expansion chamber during purge solution change.
Check valve	The yellow check valve ensures that purge fluid does not flow in the reverse direction when the purge solution is exchanged.

AUTOMATED IMPELLA CONTROLLER

The Automated Impella Controller (see Figure 3.4) provides three vital functions to the operation of the Impella Catheter:

- The controller provides an interface for monitoring and controlling the function of the Impella Catheter
- The controller provides a purge fluid to the Impella Catheter
- The controller provides backup power when the Impella Ventricular Support Systems are operated away from AC power

The controller weighs 26 lbs (11.8 kg) and can operate on its internal battery for at least 60 minutes when fully charged.

Automated Impella Controller operation is described in detail in Section 4 of this manual.



Figure 3.4 Automated Impella Controller – Front View

Automated Impella Controller Battery Power

The controller can operate on its internal lithium-ion (Li-Ion) battery for at least 60 minutes when fully charged.

Automated Impella Controller Power Cord

Use caution when moving equipment to prevent damaging the controller's power cord.

PURGE CASSETTE



Do not use saline in the purge system.

The purge cassette delivers rinsing fluid to the Impella Catheter. The purge fluid (typically 5% dextrose solution in water with Heparin) flows from the purge cassette through the catheter to the microaxial blood pump to prevent blood from entering the motor. When the purge cassette is properly installed in the Automated Impella Controller, the Abiomed logo is upright and facing you. Figure 3.5 illustrates the purge cassette and related components. Table 3.3 describes each component.

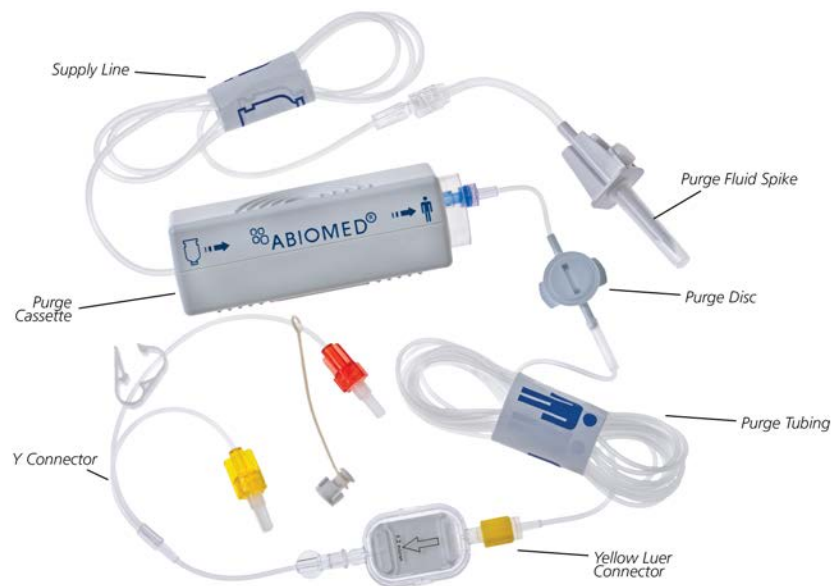

Figure 3.5 Purge Cassette

Table 3.3 Purge Cassette Components

Component	Description
Purge fluid spike	One end spikes the purge fluid bag and the other end connects the bag to the purge cassette supply line
Supply line	Carries fluid from the purge fluid bag to the purge cassette
Purge cassette	Contains the components for delivering the purge fluid; the purge fluid maintains the pressure barrier between the blood and the motor to prevent blood from entering the motor
Purge disc	Transmits pressure to the controller based on the purge pressure in the purge tubing; a sensor in the controller measures the pressure so that it can be displayed on the screen and used by the purge pressure algorithm to maintain the purge pressure
Purge tubing	Carries purge fluid from the purge cassette to the Impella Catheter
Yellow luer connector	Connects the purge tubing to the check valve (yellow luer lock) on the Impella Catheter after system change and initial set-up of Impella 5.5.
Y connector <i>Not for use with Impella 5.5 with SmartAssist</i>	Adapter that connects the purge tubing to the sidearms of the Impella 2.5 or Impella CP Catheter during case start. The Y connector consist of: <ul style="list-style-type: none"> • Yellow luer that connects to the clear sidearm • Red luer that connects to the red sidearm • Cap for the red luer when it is disconnected from the sidearm for transfer to the standard configuration • Clamp for the purge tubing leading to the red sidearm • Rectangular antibacterial air filter

ACCESSORIES

Table 3.4 illustrates and describes the accessories used with the Impella Catheter and Automated Impella Controller.

Table 3.4 Impella Catheter and Automated Impella Controller Accessories

Guidewire Use

It is important to use only the guidewire supplied with the system or an Abiomed-approved alternative.



Component	Description
	<p>The Impella Axillary Insertion kit facilitates placement of the Impella 5.5 Catheter via the axillary artery. It contains a 23 Fr diameter x 6 cm length peel-away introducer and two (2) graft locks used to attach a graft onto the introducer. (Note: Only one graft lock is required when used with the recommended Hemashield Platinum graft; a backup is provided.) The kit is packaged with an 8 Fr silicone-coated lubrication dilator. It is recommended to be used in conjunction with a 10 mm diameter x 20 cm length Hemashield Platinum graft.</p>
	<p>The 0.018 inch, 260 cm placement guidewire is used for the placement of the Impella Catheter. The guidewire has a radiopaque, shapeable tip.</p>
	<p>The two silicone plugs can be placed around the catheter shaft to help control bleeding during and after Impella 5.5 Catheter insertion.</p>

Figure 3.6 Impella Axillary Insertion Kit

Figure 3.7 Placement Guidewire

Figure 3.8 Silicone Plugs (Included with the Impella 5.5)

Component

Figure 3.9 Dextrose Solution

Description

Hospital Provided:

Dextrose solution (typically 5% dextrose in water with 25 or 50 IU/mL of heparin) is used as the purge fluid through the Impella Catheter.



Figure 3.10 Automated Impella Controller Cart

The Automated Impella Controller cart holds the Automated Impella Controller. The cart has wheels for easy transport of the controller and a storage basket.

4 USING THE AUTOMATED IMPELLA CONTROLLER™

OVERVIEW.....	4.1
AUTOMATED IMPELLA CONTROLLER FEATURES.....	4.1
HOME SCREEN	4.5
PLACEMENT SCREEN.....	4.8
Ao Placement Signal Waveform	4.9
Motor Current Waveform.....	4.9
PURGE SCREEN	4.10
Purge Flow	4.10
Purge Pressure.....	4.10
INFUSION HISTORY SCREEN.....	4.11
LVEDP TREND SCREEN.....	4.12
MOBILE OPERATION.....	4.13

Page intentionally left blank

Page intentionally left blank

OVERVIEW

The Automated Impella Controller is the primary user control interface for the Impella Catheter. It controls the Impella Catheter performance, monitors the catheter for alarms, and provides real-time catheter position information regarding the location of the catheter across the aortic valve. The controller can be powered by AC power or can operate on internal battery power for at least 60 minutes when fully charged.

This section of the manual discusses Automated Impella Controller features and displays.

AUTOMATED IMPELLA CONTROLLER™ FEATURES

IMPORTANT NOTE: The underside of the Automated Impella Controller has a battery switch to turn on the batteries. This switch is turned off for shipping purposes. Before operating the Automated Impella Controller for the first time, make sure you turn this switch on. If the battery switch is not turned on, the Automated Impella Controller will not be able to operate on battery power.

Figure 4.1 illustrates the features on the front of the Automated Impella Controller. These features are described in Table 4.1.



Figure 4.1 Automated Impella Controller Features – Front View

Table 4.1 Automated Impella Controller Front View Features

Feature	Description
Display screen	Displays user information, including the labels for the soft buttons. (Display screen elements described in detail later in this section.)
Soft buttons	<p>Display, open, and close menus. The function for each soft button is defined by labels adjacent to the button on the display screen; function changes depending on the screen. (Soft button functions are described in Table 4.3.)</p> <p>When the Impella Catheter is running, the default soft button labels are as follows:</p> <ul style="list-style-type: none"> • MUTE ALARM • FLOW CONTROL • DISPLAY • PURGE MENU • MENU
Power indicator	<p>LED light above the selector knob; indicates the power status of the Automated Impella Controller.</p> <ul style="list-style-type: none"> • Green light—controller is on and plugged into AC power or running on battery power • Amber light—controller is off but plugged into AC power • No light—controller is off and not plugged into AC power
Selector knob	Rotating push button; turn clockwise and counterclockwise to navigate through menu items; push to make a selection.
Purge disc	A flexible diaphragm on the purge cassette tubing used to monitor purge pressure and regulate purge flow.
Catheter plug	Connection point on the controller for the Impella Catheter.
Purge cassette	Contains the components for delivering the purge fluid; maintains the pressure barrier between the blood and the motor to prevent blood from entering the motor. (The purge cassette and its components are described in section 3 of this manual.)
Purge cassette door	Spring-loaded door that opens to provide access to the purge cassette.

Figure 4.2 illustrates the features on the left and right sides of the Automated Impella Controller. These features are described in Table 4.2.

Note: Console shown does not have Impella Connect.



Figure 4.2 Automated Impella Controller Features – Side Views

Table 4.2 Automated Impella Controller Side View Features

Feature	Description
Bed mount	Metal bracket on the back of the controller; attaches controller to the cart or bed
Purge cassette door release	Button located on the left side of the controller; press to open the purge cassette door
VGA OUT	Connection for connecting the controller to another monitor to slave the display
USB connector	Interface for data transfer by Abiomed maintenance or service personnel
Service	Connection used by Abiomed maintenance or service personnel
AC fuses	Electrical safety device in the event of current overload
AC plug	Connection point on the controller for the AC power cord
Power switch	<p>Button that turns the controller on or off</p> <ul style="list-style-type: none"> • ON: Press and hold the power switch for 3 seconds • OFF: (1) Disconnect the Impella Catheter from the Automated Impella Controller (2) Press and hold the power switch for 3 seconds (3) A pop-up confirmation box will appear (4) Press OK using the selector knob to confirm that the controller should be turned off <p>NOTE: Holding down the power switch for longer than 30 seconds during operation will cause the controller to initiate an emergency shutdown</p>
Equipotential ground stud	Used to ground the Automated Impella Controller according to hospital procedures
Ethernet jack	Connection for downloading data

HOME SCREEN

The home screen displays operating parameters and information for the entire Impella Ventricular Support Systems. Figure 4.3 illustrates the home screen. Each element of the display is described in Table 4.3.

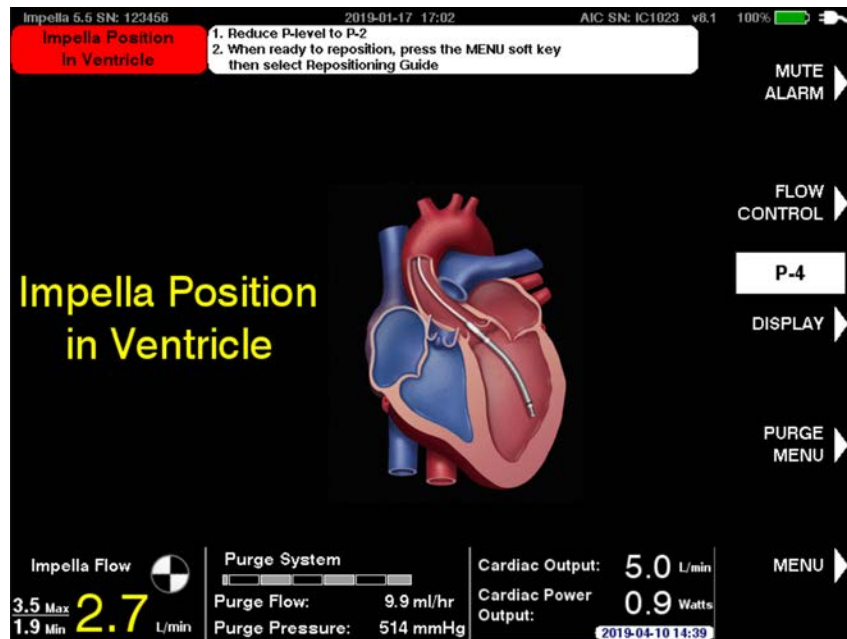

Figure 4.3 Home Screen with Pump Metrics enabled

Automated Impella Controller Software Header

The remaining screen shots in this Instructions for Use Manual do not display the header. This is for the purpose of the manual only. The header is present on all screens during use.

Table 4.3 Automated Impella Controller Display Elements

Display Element	Description
Alarm window	<p>The alarm window displays up to 3 alarms simultaneously, in order of priority from top to bottom.</p> <p>For each alarm, the alarm window displays:</p> <ul style="list-style-type: none"> • Alarm header – displayed in the left column; window is color-coded red for critical alarms, yellow for serious alarms, white for advisory notifications, gray for resolved alarms • Detailed text – up to 3 lines of instructions for resolving the alarm condition are displayed in the right column of the alarm window next to the alarm header and subhead information <p>(See section 8 of this manual for further discussion of alarms.)</p>
Catheter serial number	<p>Displayed in the upper left of the display screen if a catheter is connected to the controller.</p>
System date and time	<p>The current date (YYYY-DD-MM) and time (24-hour format; HH:MM) are displayed in the upper center of the screen display. (In figure 4.3 it is January 17, 2019 at 5:02pm)</p>
Automated Impella Controller Serial Number and SW version	<p>The AIC serial number and the current SW version are shown in the upper right of the display screen</p>
P-Level Indicator	<p>Displays current P-Level of Impella heart pump.</p>
Soft button labels	<p>The soft buttons on the Automated Impella Controller have corresponding labels adjacent to them on the display screen. These labels change depending on the type of screen displayed. (Refer to Appendix B in this manual for more details about the menu structure.)</p> <p>MUTE ALARM – Mutes (silences) active alarms for two minutes</p> <p>Mute alarm indicator</p> <p>Displayed in place of the words “MUTE ALARM” when an alarm is silenced. (See section 8 of this manual for more information about the mute alarm function; Figure 8.1 illustrates the mute alarm indicator.)</p> <ul style="list-style-type: none"> • Yellow bell with red X displayed when an alarm is muted • Not displayed when an alarm is active (but not muted) or when there are no active alarms <p>FLOW CONTROL – Allows you to control the flow of the Impella Catheter</p> <p>DISPLAY – Displays the menu for viewing waveforms and navigating to other screen displays</p> <p>PURGE MENU – Displays the Purge Menu for changing the purge fluid, changing the fluid and cassette or de-airing the purge system</p> <p>MENU – Displays a menu of options related to controller settings, alarm history, and starting a case</p> <p>Additional soft button functions may appear during specific controller procedures.</p>
Pump Metrics Area	<p>Cardiac Output and Cardiac Power Output information is displayed to the right of the purge system on the bottom of the display screen</p> <p>Cardiac Power Output – The number appears white if the cardiac power output value is above 0.6; yellow, if the value is 0.6 or below.</p> <p>Timestamp – Indicates the last time a cardiac output was entered and the cardiac power output was calculated.</p>

Table 4.3 Automated Impella Controller Display Elements (continued)

Display Element	Description
System power area	<p>System power information is displayed in the top right corner of the display screen.</p> <p>Battery status – Bar within battery symbol indicates the overall remaining capacity of the batteries</p> <ul style="list-style-type: none"> • Full green bar for fully charged battery • Partial green bar for battery that is at least 50% charged • Partial yellow bar for battery that is between 16% and 50% charged • Partial red bar for battery that is less than or equal to 15% charged • Moving gray bar for battery that is in charging mode • Percentage of battery power remaining displayed to the left of the battery icon <p>AC plug indicator</p> <ul style="list-style-type: none"> • White plug indicates that the controller is running on AC power • White plug with a red X indicates no AC power detected and the controller is running on battery power
Purge system area	<p>Information about the purge system is displayed to the right of the flow area at the bottom of the display screen.</p> <p>Purge system marquee—scrolls from left to right when purge system is operating.</p> <ul style="list-style-type: none"> • Slow scrolling represents normal purge flow rate • Fast scrolling represents bolus flow rate and priming flow rate <p>Purge flow</p> <ul style="list-style-type: none"> • Current purge flow displayed in mL/hr below the purge system marquee if the purge flow is known • Not displayed when the purge system is stabilizing, when there is no purge cassette, or when the procedure has not yet started <p>Purge pressure</p> <ul style="list-style-type: none"> • Current purge pressure (pressure of the purge fluid delivered through the catheter to the motor) displayed in mmHg below the purge flow
Flow area	<p>Information about Impella Catheter flow is displayed in the lower left corner of the display screen.</p> <p>Max/Min</p> <ul style="list-style-type: none"> • Max/Min displays the range for the flow rate <p>Current flow rate</p> <ul style="list-style-type: none"> • Mean catheter flow displayed in liters per minute (L/min)—the numbers appear in <i>white</i> if the catheter position is correct; <i>yellow</i> if the catheter position is incorrect or unknown • If the system is unable to calculate flow, a yellow triangular caution icon is displayed with the message “Flow Calculation Disabled” <p>Catheter operation icon</p> <ul style="list-style-type: none"> • The circular catheter operation icon rotates when the Impella Catheter is running

Purge System Stabilization

The purge system must stabilize after case start, a purge procedure, or resolution of a purge alarm. During this time, it may take up to 3 minutes for purge system information to display on the screen.

Table 4.3 Automated Impella Controller Display Elements (continued)

Display Element	Description
Central display area	<p>On the home screen, the central display area displays a heart pictogram and Impella Catheter position indicator message.</p> <p>Heart pictogram appears in the center of the home screen display.</p> <ul style="list-style-type: none"> • Provides a visual representation of the current Impella Catheter position • Overlaid with a translucent yellow “?” when the controller cannot determine catheter position, position is wrong, or placement monitoring is suspended or disabled <p>Impella Catheter position indicator message displayed to the left of the heart icon.</p> <ul style="list-style-type: none"> • Displays “Impella Position OK” in green when catheter position is correct • Displays “Impella Position in Ventricle” in yellow when catheter is in the ventricle • Displays “Placement Monitoring Suspended” in yellow when there is a fault in the sensor • Displays “Placement Monitoring Disabled” in yellow when you turn off placement monitoring through the menu • Displays “Impella Position in Aorta” in yellow when catheter is in the Aorta • Displays “Placement Signal Low” in yellow when the minimum Ao placement signal is low

Retrograde Flow

A setting of P-0 will result in retrograde flow when the Impella Catheter is placed across the aortic valve. Retrograde flow may also occur at P-1.

PLACEMENT SCREEN

The placement screen (see Figure 4.4) displays real-time operating data for the system. The screen displays the placement signal and motor current waveforms as well as the maximum/minimum and average values for each waveform in the central display area of the screen.

Use the **DISPLAY** soft button to navigate to the placement screen.

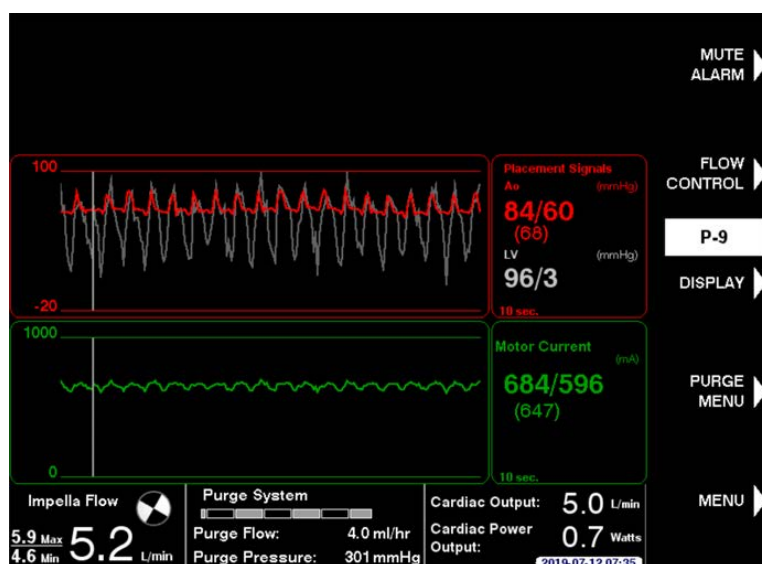

Figure 4.4 Placement Screen

Figure 4.4 shows three time-based waveform signals from different sources.

- Ao placement signal waveform
- LV placement signal
- Motor current waveform

AO PLACEMENT SIGNAL WAVEFORM

The Ao placement signal waveform displays a pressure measurement that is useful for determining the location of the fiber-optic sensor with respect to the aortic valve. The placement signal is used to verify whether the Impella Catheter is in the aorta or in the ventricle by evaluating the current pressure waveform as an aortic or ventricular waveform or by evaluating the differential pressure as pulsatile or flattened. The scale for the placement signal waveform is displayed to the left of the waveform. The default scaling is 0–160 mmHg or -20–160 mmHg. It can be adjusted in 20 mmHg increments, with a minimum upper limit of 100 mmHg and a maximum upper limit of 240 mmHg.

The LV placement signal waveform displays a calculated waveform that is useful in managing the Impella Heart Pump. The LV waveform can be disabled temporarily by pressing the DISPLAY soft button and selecting Disable LV Signal. The waveform can be re-enabled following the same steps.

To the right of the waveforms is a display that labels the waveform, provides the units of measurement, and shows the maximum and minimum values and the average value from the samples received. At the bottom of that window is the time scale, which you can set by pressing the DISPLAY soft button.

MOTOR CURRENT WAVEFORM

Motor current is a measure of the energy intake of the Impella Catheter motor. The energy intake varies with motor speed and the pressure difference between the inlet and outlet areas of the cannula. Motor current (see Figure 4.4) provides information about the catheter position relative to the aortic valve. When the Impella Catheter is positioned correctly, with the inlet area in the ventricle and the outlet area in the aorta, the motor current is pulsatile because the pressure difference between the inlet and outlet areas changes with the cardiac cycle. When the inlet and outlet areas are on the same side of the aortic valve, the motor current will be dampened or flat because there is little or no pressure difference between the inlet and outlet areas.

The scale for the motor current waveform is displayed to the left of the waveform. The default scaling is 0–1000 mA. It is adjustable in 100 mA increments for the Impella Catheter, with a minimum difference between upper and lower limits of 200 mA and a maximum difference of 1000 mA.

To the right of the waveform is a display that labels the waveform, provides the units of measurement, and shows the maximum and minimum values and the average value from the samples received. You can set the time scale at the bottom of that window by pressing the DISPLAY soft button.

PURGE SCREEN

The purge screen (see Figure 4.5) displays purge system data. In the central display area of the screen, the purge flow rate and purge pressure are plotted as a function of time. To the right of the plots, the current purge flow rate and purge pressure are displayed.

Use the **DISPLAY** soft button to navigate to the purge screen.

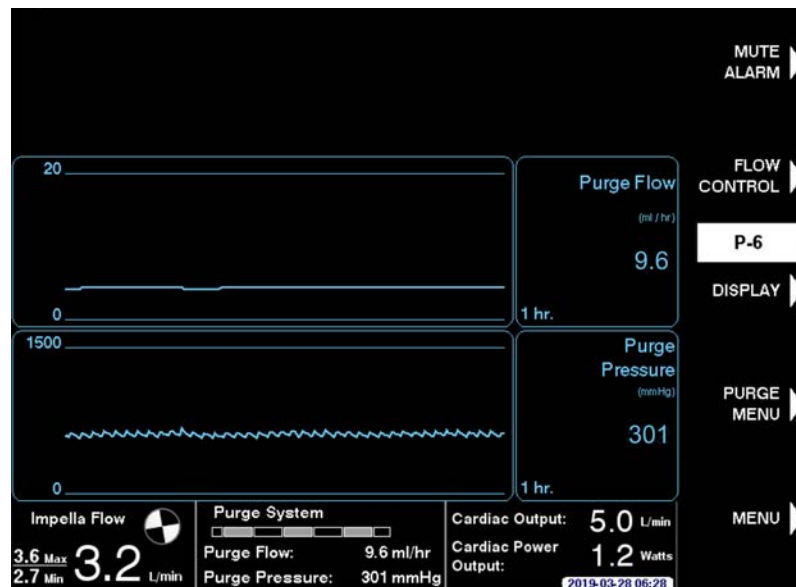

Figure 4.5 Purge Screen

PURGE FLOW

The purge flow rate delivered by the purge cassette is displayed in mL/hr. The standard scale for the purge flow (0–30 mL/hr) is displayed to the left of the purge flow plot. The maximum value on this scale can be adjusted from 20 mL/hr to 200 mL/hr in increments of 10 mL/hr.

To the right of the plot is a display that labels the plot and shows the most recent value update. You can set the time scale at the bottom of the window by pressing the **DISPLAY** soft button.

A purge flow change notification can be enabled to indicate when the purge flow rate increases or decreases by 2.5 mL/h. The message is intended to aid patient management by alerting the clinician to changes in the rates of dextrose and heparin infusion through the purge fluid. The alarm clears when you press the **MUTE ALARM** button. This alarm is disabled by default. To enable this alarm, press **MENU**, select Settings/Service, and select Enable Purge Flow Change Notification.

PURGE PRESSURE

The Automated Impella Controller regulates purge pressure, the pressure of the purge fluid delivered through the catheter to the motor. The purge pressure generated by the purge cassette is displayed in mmHg. The standard scale for the purge pressure (0–1500 mmHg) is displayed to the left of the purge pressure plot. The maximum value on this scale can be adjusted from 100 mmHg to 2000 mmHg in increments of 100 mmHg. The purge pressure in the system is set

to an ideal pressure between 300-1100 mmHg and the purge flows are between 2-30 mL/hr. An alarm appears if purge pressure falls below 300 mmHg or exceeds 1100 mmHg.

To the right of the plot is a display that labels the plot and shows the most recent value update. You can set the time scale at the bottom of the window by pressing the **DISPLAY** soft button.

INFUSION HISTORY SCREEN

The infusion history screen displays the infusion volume as well as the amount of heparin and dextrose infused each hour. The current time period is displayed at the top of the list.

Use the **DISPLAY** soft button to navigate to the infusion history screen.

Figure 4.6 shows a sample infusion history screen.



Figure 4.6 Infusion History Screen

The heparin infused via the Impella purge system should be monitored and included in institutional anti-coagulation protocols. Failure to do so, may result in excessive heparin being infused, which may cause increased bleeding at the percutaneous and surgical access sites. Additional information on use of the heparin infusion for anti-coagulation can be found in Section 7 (see Anti-coagulation Therapy with Impella Heparin Infusion on page 7.25)

LVEDP TREND SCREEN

The LVEDP Trend Screen displays trends for Mean Ao, LVEDP and Impella Flow. In the central display area of the screen, the metrics are plotted as a function of time.

Current values display to the right of the plots. A negative LVEDP value will not be displayed.

These trends are informational, do not use for diagnostic purposes. Verify all parameters displayed independently using either a cleared or approved diagnostic device. Do not use for patient monitoring. Refer to section 9 for information on accuracies.

Use the **DISPLAY** soft button to navigate to the trend screen.

Once in the trend screen, use the **DISPLAY** soft button to change the timescale and y-scale. Figure 4.7 below shows a sample trend screen.



Figure 4.7 LVEDP Trend Screen

MOBILE OPERATION



The Li-Ion batteries must be charged for 5 hours prior to system operation in order to meet the runtime requirement of 1 hour. Failure to do so will yield a shorter runtime. After being unplugged, the Automated Impella Controller will operate for at least 60 minutes after the batteries have been fully charged.

The Automated Impella Controller can be operated on internal battery power when it is not connected to AC power.

1. Disconnect the Automated Impella Controller from AC power.
2. The Automated Impella Controller beeps once every 5 minutes to alert you that it is running on battery power and a white advisory notification appears in the alarms area on the screen.
3. When the Automated Impella Controller is connected back to AC power, the white advisory notification turns gray and the X is removed from the power icon.



5 USING THE AUTOMATED IMPELLA CONTROLLER™ WITH THE IMPELLA CATHETER

PRE-SUPPORT EVALUATION.....	5.1
STARTUP.....	5.2
Supplies Needed.....	5.2
TURNING ON THE AUTOMATED IMPELLA CONTROLLER.....	5.3
The Startup Screen	5.4
CASE START.....	5.5
Insert Purge Cassette.....	5.5
Connect the Impella Catheter	5.6
Enter Purge Fluid Data.....	5.9
Secure the Purge Tubing	5.10
AXILLARY INSERTION OF THE IMPELLA 5.5 CATHETER.....	5.11
Alternate Insertion Technique Using a Sidearm Graft & Silicone Plugs	5.15
DIRECT AORTIC INSERTION.....	5.17
Implantation Preparation.....	5.17
POSITIONING & STARTING IMPELLA 5.5 WITH SMARTASSIST CATHETER.....	5.19
Use of the Repositioning Unit	5.20
P-Level	5.21
ADJUSTING THE LV PLACEMENT SIGNAL	5.22
ENTERING CARDIAC OUTPUT	5.24
PURGE CASSETTE PROCEDURES.....	5.26
Change Cassette and Bag.....	5.26
Change Purge Fluid Bag	5.27
De-Air Purge System.....	5.27
Air Detected Alert.....	5.28
TROUBLESHOOTING THE PURGE SYSTEM	5.29
Purge Pressure Low	5.29
Purge System Blocked.....	5.29
Purge System Open	5.29
PATIENT WEANING.....	5.30
Rapid Weaning.....	5.30
Slow Weaning	5.30
REMOVING THE IMPELLA 5.5 WITH SMARTASSIST CATHETER.....	5.31
Removing the Impella Catheter with the Introducer in Place.....	5.31
Removing the Impella Catheter Secured with the Repositioning Sheath.....	5.31
Vascular Graft Closure.....	5.31

Page intentionally left blank

PRE-SUPPORT EVALUATION

Before initiating the procedure, evaluate the patient for factors that may prevent successful placement of the Impella Catheter. Use imaging technology to examine the patient's vasculature access site. An echo assessment of the left ventricle is also recommended to rule out left ventricular thrombus, mechanical aortic valves, or severe aortic insufficiency. Consider inserting a diagnostic Pulmonary Artery (PA) catheter to provide continuous hemodynamic monitoring, including pulmonary artery and central venous pressures, measurement of cardiac output, and SvO₂.

Table 5.1 Evaluation Prior to Inserting the Impella Catheter

Technology	Observations
• Standard traditional angiography	• LV thrombus
• Magnetic resonance angiography (MRA)	• Mechanical aortic valve
• Coronary computed tomography angiography (CTA)	• Aortic valve stenosis / calcification
• Ultrasound	• Moderate to severe aortic insufficiency
• Echocardiography	• RV failure
	• Minimal 7 mm vessel diameter (Impella 5.5)

STARTUP



Do **NOT** use Impella Ventricular Support Systems if any part of the system is damaged.



The sterile components of the Impella Ventricular Support Systems can be used only if the sterilization indicators show that the contents have been sterilized, the packaging is not damaged, and the expiration date has not elapsed.



Do **NOT** resterilize or reuse the Impella Catheter. It is a disposable device and is intended for single-use only.



To prevent malfunction of the Automated Impella Controller, avoid long-term exposure to direct sunlight and excessive heat (40°C).



To prevent overheating and improper operation, do **NOT** block the cooling vents of the Automated Impella Controller while it is operating.



The Li-Ion batteries must be charged for 5 hours prior to system operation in order to meet the runtime requirement of 1 hour. Failure to do so will yield a shorter runtime. After being unplugged, the Automated Impella Controller will operate for at least 60 minutes after the batteries have been fully charged.



Have a backup Automated Impella Controller, purge cassette, and Impella Catheter available in the unlikely event of a device failure.

SUPPLIES NEEDED

- Automated Impella Controller
- Impella 5.5 with SmartAssist Catheter
- Diagnostic catheter (AL1 or MP without side holes or pigtail with or without side holes)
- 500 cc bag of dextrose solution for purge solution in water (5% recommended; 5% to 20% acceptable) with 25 or 50 IU heparin/mL
- Impella Axillary Insertion kit for axillary insertion of the Impella
- 10 mm x 20 cm Hemashield Platinum vascular graft (if using Axillary Insertion kit)

TURNING ON THE AUTOMATED IMPELLA CONTROLLER

To turn the controller on:

1. Press and hold the power switch on the right side of the Automated Impella Controller for 3 seconds (see Figure 5.1).



Power Switch
on Right Side of
Impella® Controller

Figure 5.1 Automated Impella Controller Power Switch

The Automated Impella Controller automatically performs a system test when turned on.

A display bar shows the progress of the system test. If the system test passes, the system displays the startup screen (see Figure 5.2).

If the system test fails, the controller displays a system self check failure message:

**SYSTEM SELF CHECK FAILED.
CHANGE CONSOLE IMMEDIATELY.**

Battery Switch

Before operating the Automated Impella Controller for the first time, turn on the switch on the underside of the controller to turn on the batteries.

System Self Check

The console will beep during self-check to check the functionality of the alarm.

THE STARTUP SCREEN

The startup screen (see Figure 5.2) appears when you successfully turn on the Automated Impella Controller.

Check Date and Time

The current date and time appear at the top of the startup screen. Confirm that these are correct. For more information, refer to Appendix B

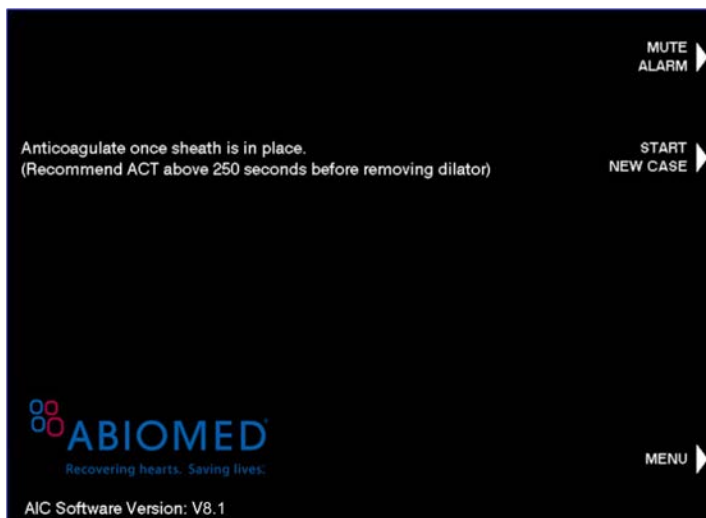

Figure 5.2 Automated Impella Controller Startup Screen

The startup screen displays the current version of the software that the Automated Impella Controller is running.

The startup screen also displays system power information along the bottom of the screen and three active soft buttons—MUTE ALARM, MENU, and START NEW CASE—along the right side of the screen.

Sensitive Medical Device

The Impella Catheter is a sensitive medical device with extremely fine tolerances. In particular, the inlet and outlet areas of the catheter assembly may be damaged if subjected to strong external forces.

CASE START



Fluoroscopy is required to guide placement of the Impella Catheter during rewire through the guidewire access port. The 0.018" placement guidewire must be reliably observed at all times.



The sterile components of the Impella Ventricular Support Systems can be used only if the sterilization indicators show that the contents have been sterilized, the packaging is not damaged, and the expiration date has not elapsed.



Avoid manual compression of the inlet and outlet areas of the cannula assembly.



Do **NOT** remove the Impella Catheter over the length of the guidewire.



Handle with care. The Impella Catheter can be damaged during removal from packaging, preparation, insertion, and removal. Do **NOT** bend, pull, or place excess pressure on the catheter or mechanical components at any time.



Do **NOT** kink or clamp the Impella Catheter with anything other than a soft jaw vascular clamp. Do **NOT** kink or clamp the peel-away introducer.

CASE START

1. Press the **START NEW CASE** soft button from the startup screen or plug in a new Impella Catheter. Case Start can also be initiated by pressing the **MENU** soft key and then selecting Case Start.
2. The controller displays the screen shown in Figure 5.3.

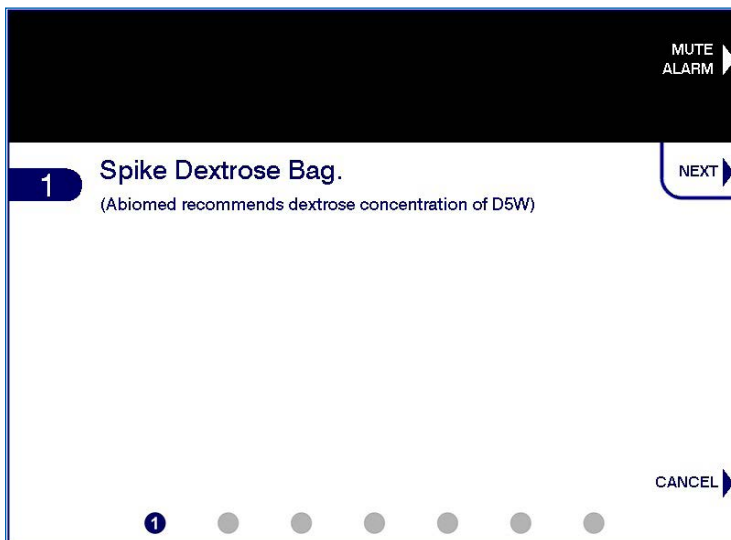

Figure 5.3 Initial Case Start Screen

INSERT PURGE CASSETTE

1. Open the purge cassette package.
2. If included, discard the Y-connector and secure the yellow luer connector on the purge tubing to the sterile field.
3. Pass the purge cassette and spike off the sterile field.
4. Spike the dextrose bag/bottle.
5. Press the **NEXT** soft button to continue.
6. Open the purge cassette door by pressing the release on the left side of the controller. Insert the purge cassette into the Automated Impella Controller (as shown in Figure 5.4)

Shaded Steps

All shaded steps require sterile technique.

Purge Solution Bottles

If the purge solution is supplied in bottles, open the vent on the purge fluid spike and follow the same procedure as if supplied in bags.

Connect Purge Disc Within 3 Seconds

The instructions for inserting the purge disc appear if it is not snapped into place within 3 seconds of inserting the purge cassette.

Close Purge Cassette Door

Once the purge cassette is installed, be sure to close the purge cassette door to prevent the purge cassette from being dislodged accidentally.

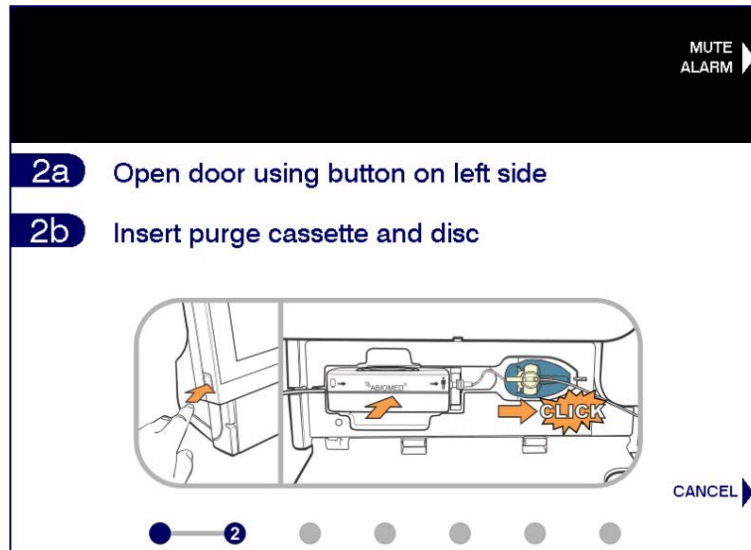

Figure 5.4 Inserting Purge Cassette into Automated Impella Controller

7. Insert the purge cassette into the compartment on the front of the controller. Follow the diagram on the inside of the purge cassette door for proper placement.
8. Slide the purge disc into the slot to the right of the purge cassette until it snaps into place. The controller will automatically begin priming the purge cassette.
9. Extend the purge tubing and close the purge cassette door. There is sufficient room around the edges of the purge cassette door so that it will not pinch the purge tubing as it exits.
10. The controller automatically begins priming the purge cassette after it is inserted. The progress bar shown in Figure 5.6 marks the progress of the purge cassette priming.

CONNECT THE IMPELLA CATHETER

1. Remove the Impella Catheter from its package using sterile technique and inspect the catheter for damage.
2. Inspect the cable for damage, including damage to the connector pins at the controller end.
3. Pass the sterile connector cable from the Impella Catheter off the sterile field.
4. Open the cover on the blue catheter plug by rotating clockwise. Line up the notch on the connector cable with the notch in the blue catheter plug on the front of the Automated Impella Controller and plug the cable into the controller. See Figure 5.5 on next page.

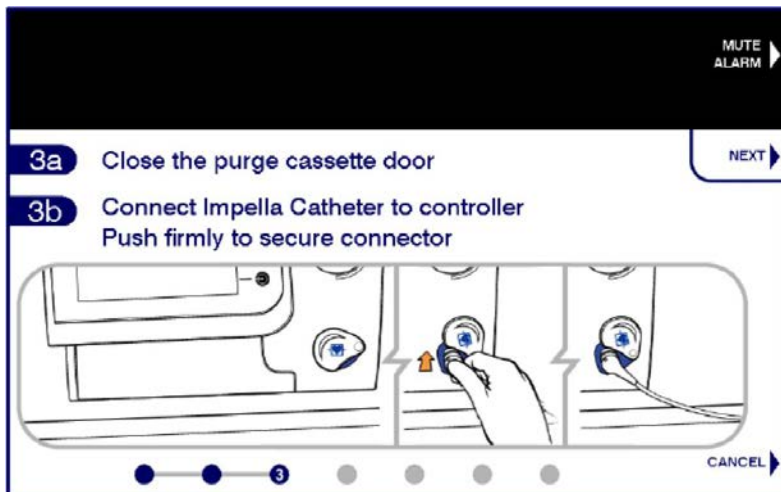

Figure 5.5 Connecting Impella Catheter

- Once the purge cassette is primed and the controller detects that the connector cable is plugged in, it prompts you to connect the luer to the Impella Catheter.

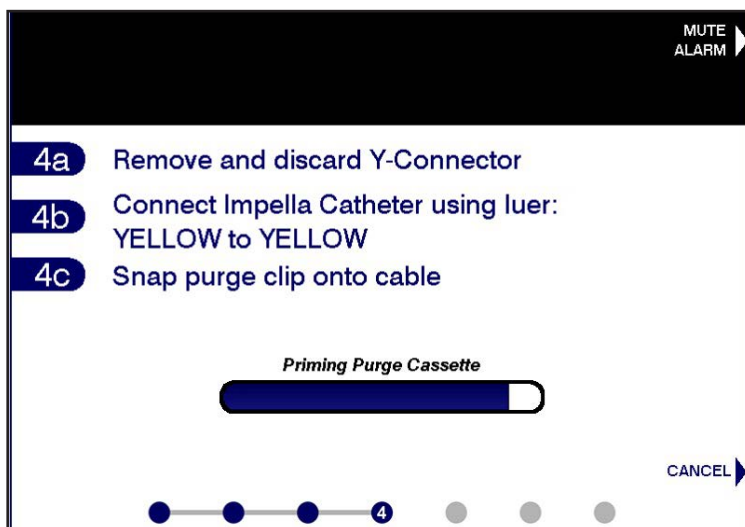

Figure 5.6 Connecting luer and priming Impella Catheter

Sensor Calibration

After the Automated Impella Controller detects the Impella Catheter is connected, the fiber optic sensor automatically starts calibration. Do not touch the sensor or move the Impella Catheter during this time.

6. If included, disconnect the Y-connector from the purge tubing and discard. Connect and tighten the yellow luer on the purge tubing to the Impella Catheter sidearm as shown in Figure 5.7, if not already complete.

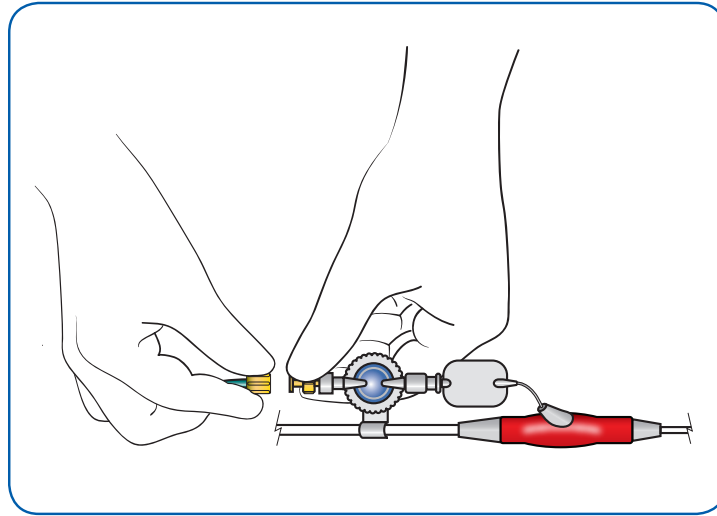

Figure 5.7 Connecting the luer to the Impella Catheter

7. When the controller detects that the luer is connected, it automatically begins priming the purge lumen.

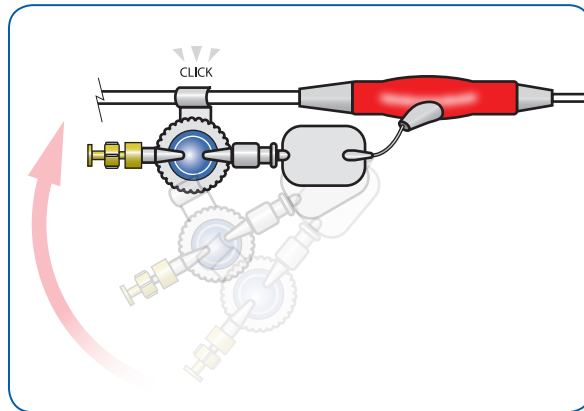

Figure 5.8 Snapping Purge Clip to Connector Cable

8. Snap the purge clip (located on the pressure reservoir of the clear sidearm) to the connector cable as shown in Figure 5.8.
9. Once the purge lumen is primed, the controller automatically advances to the next screen.
10. The first step on the next screen prompts you to enter the purge fluid information.

Important Step

Snapping the purge clip on the pressure reservoir to the connector cable is important to prevent the tube from kinking.

ENTER PURGE FLUID DATA

1. Enter the purge fluid information. The screen in Figure 5.9 shows a table of recommended default values for the purge fluid.

6 Confirm Purge Fluid information.

Purge Fluid Volume	500 ml
Dextrose Concentration	5 %
Heparin Concentration	0 IU/ml

MUTE ALARM

ACCEPT

EDIT

CANCEL

Figure 5.9 Entering Purge Fluid Information

2. To select the default values displayed on the screen, press the **ACCEPT** soft button. This will select those values and automatically advance to the next screen. Note: the Automated Impella Controller will use the default values for the purge fluid unless changed.
3. To change the purge fluid information, press the **EDIT** soft button, scroll to the appropriate item and push the selector knob to select it or use the white arrow soft keys. Then scroll through the values and push the selector knob or press **SELECT** to make a new selection. Press the **DONE** button to finish editing. The controller will use the default values if no other selections are made. See Figure 5.10.
 - Purge fluid can be set to 50 mL, 100 mL, 250 mL, 500 mL (default), or 1000 mL.
 - Dextrose concentration can be set to 5% (default), 10%, or 20%.
 - Heparin concentration can be set to 0 IU/ml, 5 IU/ml, 6.25 IU/ml, 10 IU/ml, 12.5 IU/ml, 25 IU/ml, 40 IU/ml, 50 IU/ml.

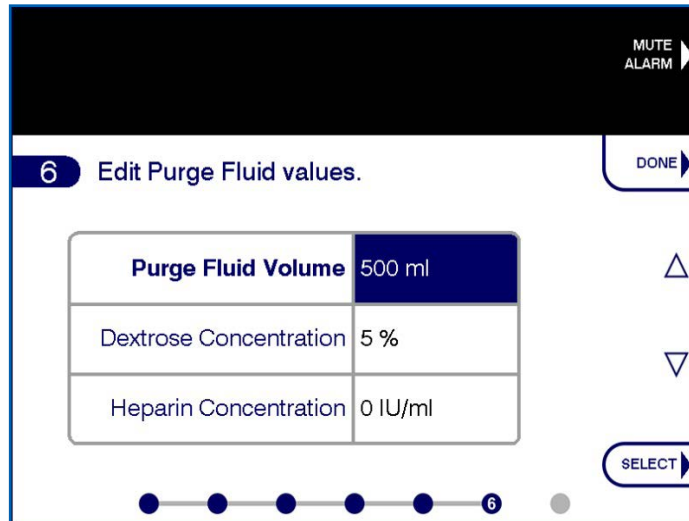

Figure 5.10 Changing the Purge Fluid Information

SECURE THE PURGE TUBING

1. To complete the setup, connect the purge tubing to the white connector cable by pushing the purge tubing into the clips attached to the white connector cable as shown in Figure 5.11.



Figure 5.11 Connecting the Purge Tubing to the Connector Cable

AXILLARY INSERTION OF THE IMPELLA 5.5 CATHETER

NOTE – Proper surgical procedures and techniques are the responsibility of the medical professional. The described procedure is furnished for information purposes only. Each physician must evaluate the appropriateness of the procedure based on his or her medical training and experience, the type of procedure, and the type of systems used.



The introducer and graft lock are supplied sterile and can be used only if the packaging is not damaged and the expiration date has not elapsed.



Fluoroscopy is required for the insertion of the Impella guidewire and Impella Catheter.



The graft must be affixed to the introducer proximal to the retainers on the introducer sheath to prevent the introducer from sliding out of the graft.



When inserting the Impella Catheter through the introducer and into the graft, be sure to clamp the graft with a vascular clamp just above the anastomosis to avoid blood loss through the pump cannula during insertion through the valve.



The Impella Axillary Insertion kit is intended to be used for insertion only. To provide continued hemostasis, the introducer must be peeled away and the repositioning sheath inserted into the graft.



Do **NOT** resterilize or reuse any components of the Impella Axillary Insertion kit. All components are disposable and intended for single-use only. Reuse, reprocessing, or resterilization may compromise performance.



The Impella Axillary Insertion kit is not designed for use with the Impella LD Catheter.



The introducer is designed to be inserted into a graft. It is not intended for direct insertion into the artery.



Be sure that the stopcock on the peel-away introducer or repositioning sheath is always kept in the closed position. Significant bleed back can result if the stopcock is open.



Abiomed recommends the use of a 10 mm diameter Hemashield Platinum graft with the introducer for proper fit and hemostasis between the graft and the introducer. A smaller diameter graft will not fit over the introducer.



Abiomed recommends the use of a 20 cm length graft to allow enough length to fully insert the Impella Catheter cannula into the graft prior to releasing vascular clamps at the anastomosis to minimize blood loss through the cannula.



Do **NOT** kink or clamp the Impella Catheter with anything other than a soft jaw vascular clamp. Do **NOT** kink or clamp the peel-away introducer.



Proper positioning of the Impella Catheter is extremely important and it is worthwhile to take extra time when positioning the catheter.



Take care to insert the guidewire with diagnostic catheter into the middle of the hemostatic valve of the introducer to avoid tearing the valve.



When inserting the Impella Catheter into the introducer, take care to insert it straight into the center of the introducer valve.

Use Fluoroscopy for Placement

Impella Catheter performance will be compromised if correct placement cannot be confirmed. While other imaging techniques, such as transesophageal echocardiography (TEE), can help confirm the position of the Impella Catheter after placement, TEE does not allow visualization of the entire catheter assembly and is inadequate for reliably placing the Impella Catheter across the aortic valve.

The following steps describe the recommended technique for axillary artery insertion of the Impella 5.5 with SmartAssist Catheter.

1. Isolate and expose the axillary artery and obtain control via proximal and distal vessel loops.
2. Attach a 10 mm diameter x 20 cm long vascular graft to the axillary artery using a standard end-to-side anastomosis. **NOTE:** Abiomed recommends using a Hemashield Platinum graft and recommends using at least a 60-degree bevel on the end of the graft to facilitate passage of the rigid motor housing into the artery.
3. Clamp the graft with a vascular clamp just above the anastomosis and loosen the vessel loops to allow blood to flow into the graft to assess for hemostasis at the anastomosis.
4. Insert the introducer into the graft and secure it with one (1) provided graft lock. To place the graft lock, open it and place it between the retainers and the hub on the introducer to prevent the introducer from sliding out of the graft (see Figure 5.12). **NOTE:** If a graft other than the Hemashield Platinum is used, 2 graft locks may be required to maintain hemostasis between the graft and the introducer. Correct positioning of the second graft is illustrated in Figure 5.13.



Figure 5.12 Introducer, Graft Lock, and Hemashield Platinum Graft (Graft Not Supplied)



Figure 5.13 Correct Positioning if Second Graft Lock Required

5. Secure the graft lock by pressing both the outside tabs together. When fully closed, the graft lock provides hemostasis. If hemostasis is not achieved, make sure to press the two tabs together to fully close the graft lock as shown in Figure 5.14. The graft lock cannot be damaged by over closing. **NOTE:** The graft may also be secured over the introducer using heavy sutures or umbilical tape.

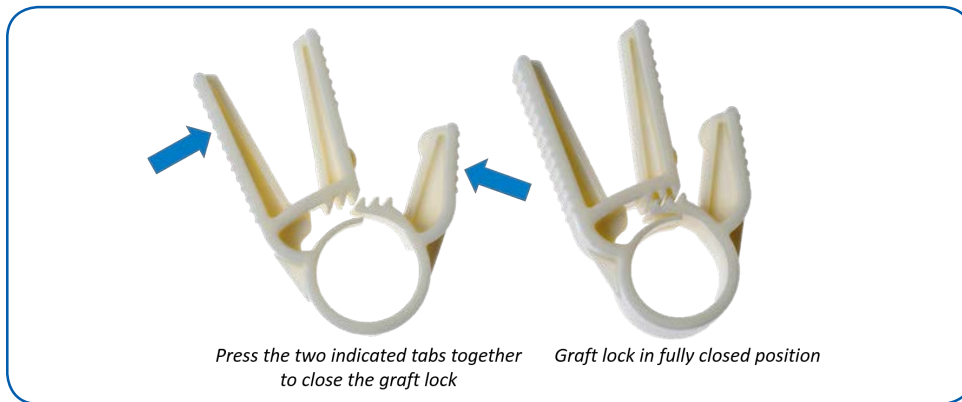

Figure 5.14 Closing the Graft Lock

6. Remove the vascular clamp on the graft and insert a 0.035 inch diagnostic guidewire with a 4–6 Fr diagnostic catheter into the introducer, taking care to center the wire and catheter in the center of the hemostatic valve. Advance the guidewire and catheter into the left ventricle.
7. Remove the diagnostic guidewire and exchange it for a stiff 0.018 inch placement guidewire. With the 0.018 inch placement guidewire properly positioned in the left ventricle, remove the diagnostic catheter.
8. Administer heparin, bivalirudin, or argatroban, per institutional protocol. When the ACT is greater than or equal to 250 seconds, remove the dilator.
9. Remove the protective sleeve on the provided 8 Fr silicone-coated lubrication dilator, being careful to avoid getting silicone on your hands. Insert the dilator into the introducer over the 0.018 inch placement guidewire to coat the hemostatic valve with silicone oil to facilitate insertion of the Impella Catheter through the hemostatic valve assembly. Once fully inserted, remove the dilator, keeping the 0.018 inch placement guidewire in place.
10. Clamp the graft with a vascular clamp just above the anastomosis to avoid blood loss through the pump cannula during insertion through the valve.
11. While maintaining guidewire position, backload the Impella Catheter onto the 0.018 inch placement guidewire and advance the catheter over the guidewire through the introducer into the graft such that the entire pump cannula and motor housing resides in the graft and only the catheter shaft is seen exiting the valve.
12. Remove the vascular clamp and continue inserting the Impella Catheter into the aorta. Continue advancing across the aortic valve using fluoroscopic imaging to properly position the cannula bend at the aortic valve annulus, placing inlet approximately 5 cm deep into ventricle. Remove the placement guidewire and initiate Impella Catheter support as described later in this section.
13. Clamp the graft adjacent to the axillary artery with a soft jawed vascular clamp or have an assistant apply digital pressure to control bleeding at the base of the graft so that the introducer can be removed and the graft shortened. **NOTE:** To ensure the soft jaw vascular clamp is completely sealing over the graft and the 9 Fr catheter, open the sidearm flush valve on the introducer and verify blood is not leaking from the system.

14. Slide the repositioning sheath back to the red Impella plug. **NOTE:** For the 23F x 6cm peel-away introducer, it may be necessary to pull the introducer over the repositioning sheath to remove the peel-away completely from the artery
15. To remove the introducer, release the graft lock by pressing the two adjacent long tabs together as shown in Figure 5.15 and remove it from the graft.

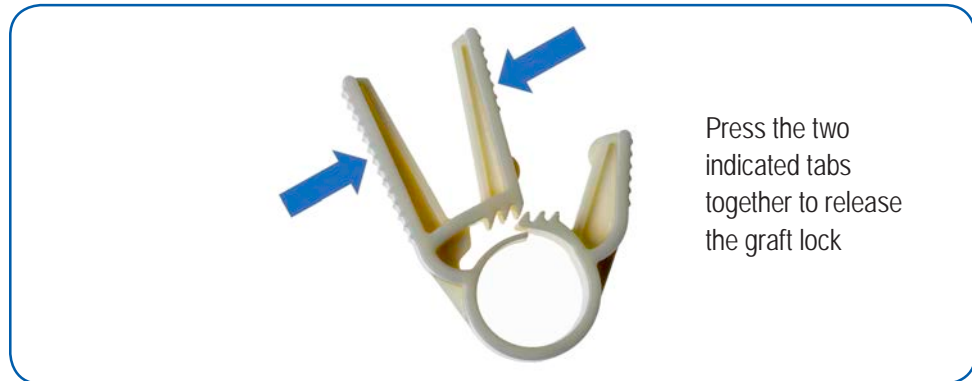

Figure 5.15 Releasing the Graft Lock

16. Slide the introducer fully out of the graft prior to peeling it away. To peel the introducer off the catheter shaft, crack the hub by applying pressure to the thumb tabs and then peel the sheath off the catheter. **NOTE:** When breaking the hemostatic valve in the sheath hub, the valve may stretch before separating.
 - a. Grasp the two “wings” and bend back until the valve assembly comes apart. Continue to peel the two wings until the introducer is completely separated from the catheter shaft (see Figure 5.16).

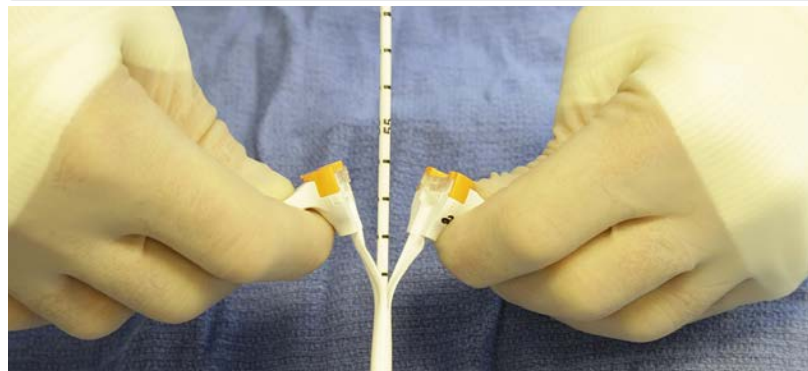

Figure 5.16 Removing the Peel-Away Introducer (14 Fr Introducer shown)

17. Trim any excess graft and slide the blue suture hub into the graft. **NOTE:** The hub should be at the skin level and the length of the remaining graft material should be just long enough to secure the graft around the blue suture hub with all of the graft buried beneath the skin.
18. Using heavy silk suture, secure the graft around the blue suture hub so that the position of the Impella Catheter can still be adjusted. Remove the vascular clamp adjacent to the axillary artery.
19. The wound should be closed over the trimmed graft with the end of the blue suture hub clearly visible. Anchor the hub securely to the skin.

20. If there is slack in the catheter, follow steps a-d below.
 - a) Loosen the Touhy-Borst, pull the catheter back until an aortic waveform is present on the placement screen.
 - b) When the aortic waveform is present, pull the catheter back an additional 3cm for Impella 5.5 with SmartAssist. (The distance between adjacent markings on the catheter is 1 cm.)
 - c) RE-TIGHTEN THE TUOHY BORST
 - d) The catheter should now be positioned correctly.
21. Extend the sterile sleeve. Attach one end to the repositioning hub and anchor the other to the catheter.

ALTERNATE INSERTION TECHNIQUE USING A SIDEARM GRAFT & SILICONE PLUGS

1. After exposing the axillary artery and making the incision as described in the steps above, prepare a Dacron® vascular graft (10 mm x 20 cm) by beveling the end of the graft at a 45 to 60 degree angle.
2. Tighten the distal and proximal vessel loops to control bleeding.
3. Attach the vascular graft using the standard end-to-side anastomosis (Figure 5.17).

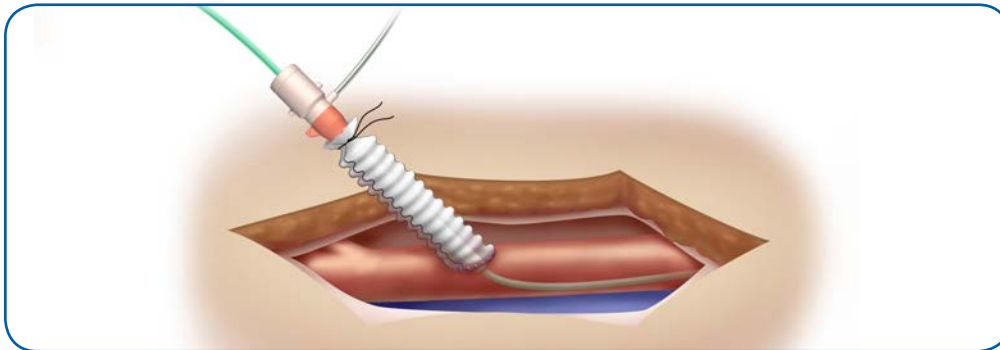

Figure 5.17 Axillary Artery Insertion of the Impella 5.5 Catheter Using a Sidearm Graft

4. Assess the anastomosis for hemostasis.
5. Attach a standard 6 Fr introducer to the distal end of the graft.
6. Advance a diagnostic catheter (Abiomed recommends a 6 Fr AL1 or Multipurpose without side holes or 4–5 Fr pigtail with or without side holes) over a diagnostic 0.035 inch or 0.038 inch guidewire into the left ventricle.
7. Remove the diagnostic guidewire and exchange it for the supplied 0.018 inch placement guidewire.
8. Tighten the vessel loops to control bleeding and remove the 6 Fr introducer.
9. Moisten the Impella 5.5 Catheter and push one of the silicone plugs onto the catheter shaft adjacent to the Impella 5.5 Catheter motor.
10. Backload the Impella 5.5 Catheter onto the 0.018 inch guidewire (as described in the steps in previous step 11).

Use TEE for Placement

Transesophageal echocardiography (TEE) is required for placement of the Impella 5.5 Catheter.

11. With the graft held at the base, place the Impella 5.5 Catheter into the open end of the graft up to the level of the silicone plug.

12. Secure umbilical tape around the silicone plug.

13. Loosen both vessel loops and advance the Impella 5.5 Catheter along the guidewire into the left ventricle until it is properly positioned.



To prevent device failure, do not start the Impella 5.5 Catheter until the placement guidewire has been removed.



Do **NOT** remove the Impella 5.5 Catheter over the length of the placement guidewire.

14. Remove the guidewire.

15. Place a soft-jawed clamp at the anastomosis and remove the silicone plug.

16. Trim any excess graft and slide the repositioning sheath into position.

17. Using a heavy silk tie or umbilical tape, secure the graft around the blue hub of the repositioning sheath.

18. Close the wound over the trimmed graft with the end of the blue suture hub clearly visible. The steering catheter for the Impella 5.5 can be manipulated if needed by unsecuring the repositioning unit and moving the catheter in or out.

19. Extend the sterile sleeve. Attach one end to the blue suture hub and anchor the other to the catheter.

DIRECT AORTIC INSERTION

NOTE – Proper surgical procedures and techniques are the responsibility of the medical professional. The described procedure is furnished for information purposes only. Each physician must evaluate the appropriateness of the procedure based on his or her medical training and experience, the type of procedure, and the type of systems used.



Avoid manual compression of the inlet, outlet, or sensor areas of the cannula assembly.



Do **NOT** kink or clamp the Impella Catheter with anything other than a soft jaw vascular clamp. Do **NOT** kink or clamp the peel-away introducer.



Handle with care. The Impella 5.5 Catheter can be damaged during removal from packaging, preparation, insertion, and removal. Do **NOT** bend, pull, or place excess pressure on the catheter or mechanical components at any time.



An incision larger than 6 mm may allow the front plug to advance into the aorta.

The Impella 5.5 Catheter is surgically implanted when there is access to the ascending aorta through a sternotomy or thoracotomy. Transesophageal echocardiography (TEE) is required to guide placement.

IMPLANTATION PREPARATION

1. Using a sterile incision template for positioning (see sidebar), place a sidebiter clamp on the aorta at least 7 cm above the valve plane.
2. Make an incision (or punch) no larger than 6 mm at the insertion site on the ascending aorta.
3. Attach the Dacron® vascular graft (10 mm x 15 cm) to the aorta using the standard end-to-side anastomosis.
4. Administer heparin and achieve ACT of at least 250 seconds.
5. When the anastomosis is complete, place a clamp at the distal end of the graft and then release the proximal clamp at the base of the graft. Examine the suture line for leaks and reclamp the graft at the base.
6. Moisten the Impella 5.5 Catheter and push both silicone plugs up against the motor housing as shown in Figure 5.18



Figure 5.18 Impella 5.5 Catheter with Silicone Plugs

Positioning the Aortic Incision

It is important to make the incision in the ascending aorta 7 cm above the aortic valve so that the Impella 5.5 Catheter can be positioned properly. An incision too close to the aortic valve annulus could result in the catheter outlet area in the graft rather than the aorta.

The incision must be ≤ 6 mm in length to prevent the front silicone plug from advancing into the aorta through the incision.

GP IIb-IIIa Inhibitors

If the patient is receiving a GP IIb-IIIa inhibitor, the Impella 5.5 Catheter can be implanted when ACT is 200 or above.

Keep ACT ≥ 250 Seconds

Maintaining ACT at or above 250 seconds will help prevent a thrombus from entering the catheter and causing a sudden stop on startup.

Securing the Front Silicone Plug

There should be no movement of the front silicone plug within the graft; however, the catheter shaft should move without resistance within the plug.

When securing the front silicone plug to the graft, do not penetrate the silicone plug too deeply as this could cause damage to the Impella 5.5 Catheter.

- 7.** With the graft clamped at the base, place the Impella 5.5 Catheter into the open end of the graft up to the level of the rear plug.
- 8.** When the catheter is in position, secure a tourniquet around the rear silicone plug. Tighten the tourniquet sufficiently to control bleeding around the rear plug while still allowing the catheter to slide through the plug.
- 9.** Release the clamp and advance the Impella 5.5 Catheter into the aorta.
- 10.** If the patient is on cardiopulmonary bypass (CPB), allow the heart to fill by restricting the return flow to the bypass machine and reducing CPB flow to a minimum setting, as long as acceptable physiologic systemic flow is maintained.
- 11.** As soon as the motor housing has passed into the aorta, use a ligature to loosely secure the front silicone plug flush to the graft. The silicone plug should be in the most proximal portion of the graft.
- 12.** While the catheter is being advanced into the aorta, the initial placement signal has the characteristics of an aortic placement signal. Do not allow the front plug to advance beyond the base of the graft
- 13.** To aid in passing the catheter through the aortic valve, apply slight pressure to the posterior aspect of the aortic valve to produce temporary aortic insufficiency.
- 14.** Gently advance the catheter forward until the inlet crosses the aortic valve and the bend of the catheter is at the level of the aortic valve annulus. Confirm with TEE guidance.

POSITIONING & STARTING IMPELLA 5.5 WITH SMARTASSIST CATHETER



Retrograde flow will occur across the aortic valve if the flow rate of the Impella Catheter is less than 0.5 L/min.

1. Reconfirm that the placement guidewire has been removed and Confirm that the controller displays a pulsatile waveform and the cannula bend at the aortic valve annulus, placing inlet approximately 5 cm deep into ventricle. (See step 6 if the controller displays a ventricular waveform.)
2. Press **START IMPELLA** soft button to open the P-level menu (see Figure 5.19). Turn the selector knob to increase the P-level from P-0 to P-2.

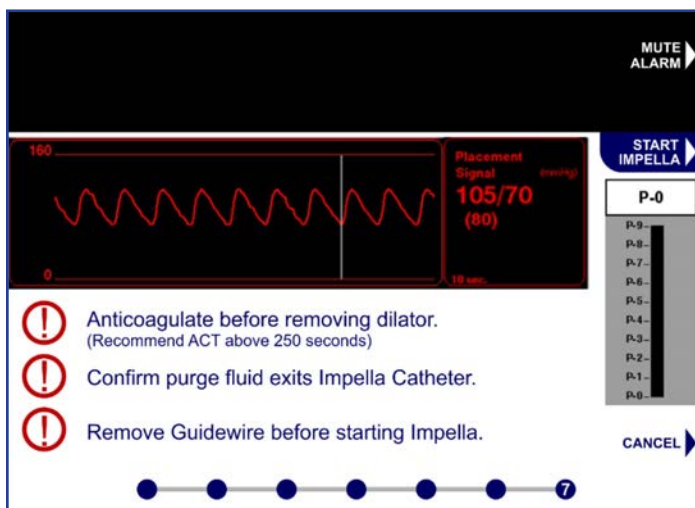

Figure 5.19 Starting the Impella 5.5 with SmartAssist Catheter

3. Press the selector knob to select the new P-level. Increase the P-level to P-9 to confirm correct and stable placement.
4. Evaluate the catheter position in the aortic arch. If there is slack in the catheter, loosen the Touhy-Borst, remove the excess slack, and RE-TIGHTEN THE TUOHY-BORST. The catheter should align against the lesser curvature of the aorta rather than the greater curvature. Verify placement with fluoroscopy and with the placement signal screen.
5. Reposition the catheter as necessary.
6. If the Impella Catheter advances too far into the left ventricle and the controller displays a ventricular waveform (see Figure 5.19) rather than an aortic waveform, follow these steps to reposition the catheter.
 - a) Loosen the Touhy-Borst, pull the catheter back until an aortic waveform is present on the placement screen.
 - b) When the aortic waveform is present, pull the catheter back an additional 3 cm for Impella 5.5 with SmartAssist. (The distance between adjacent markings on the catheter is 1 cm.)
 - c) RE-TIGHTEN THE TUOHY BORST
 - d) The catheter should now be positioned correctly.

USE OF THE REPOSITIONING UNIT

1. Slide the repositioning sheath over the catheter shaft and advance it into the graft.
2. Secure the repositioning unit to the patient with the blue suture pads or a StatLock® stabilization device.
3. Evaluate the catheter position in the aortic arch. If there is excess slack, loosen the Touhy-Borst, remove the excess slack, and RE-TIGHTEN THE TUOHY-BORST. The catheter should align against the lesser curvature of the aorta rather than the greater curvature. Verify placement with fluoroscopy and with the placement signal.
4. Attach the anticontamination sleeve to the blue section of the repositioning unit. Lock the anchoring ring in place by turning it clockwise. Secure the catheter shaft in place by tightening the connected anchoring ring.
5. Carefully extend the anticontamination sleeve to maximum length and secure the end closest to the red Impella plug by tightening the anchoring ring.
6. Select the lowest P-level that will enable you to achieve the highest flow rate necessary for patient support. You can select one of ten P-levels (P-0 to P-9) for the Impella 5.5 Catheter (see Table 5.2).

P-LEVEL

In P-LEVEL mode you can select one of ten P-levels (P-0 to P-9) for the Impella 5.5 with SmartAssist Catheter (see table below). Select the lowest P-level (P-2 or higher) that will enable you to achieve the highest flow rate necessary for patient support.

Table 5.2 P-level Flow Rates for the Impella 5.5 with SmartAssist Catheter

P-level	Mean Flow (L/min) 30 - 60 mmHg	Revolutions per Minute (RPM)
P-0	0	0
P-1	0	12,000
P-2	0 - 1.9	17,000
P-3	1.1 - 2.7	20,000
P-4	1.9 - 3.3	22,000
P-5	2.8 - 3.7	24,000
P-6	3.4 - 4.1	26,000
P-7	3.9 - 4.5	28,000
P-8	4.3 - 4.9	30,000
P-9	5.0 - 5.5	33,000

**Flow rate can vary due to suction or incorrect positioning.*

To operate the Impella Catheter in P-level mode:

1. Press the **FLOW CONTROL** soft button to open the **FLOW CONTROL** menu.
2. Turn the selector knob to increase or decrease the flow rate.
3. Press the selector knob to select the new flow rate.

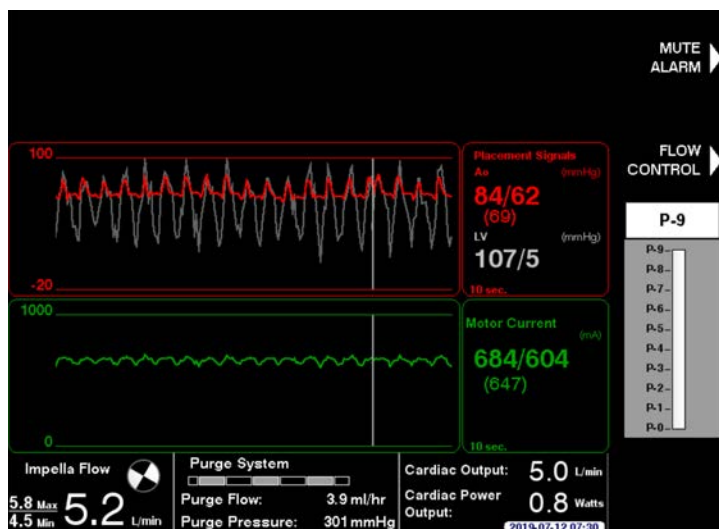

Figure 5.20 Adjusting P-level

ADJUSTING THE LV PLACEMENT SIGNAL

Refer to section 9 for information on accuracies.



The LV placement signal and LV estimates are not displayed when pumps are running at P-3 or lower. Increase pump speed to P-4 or higher to re-enable signal



Alarm conditions and low pump speeds may affect the LV placement signal and estimates



Disruption of the outlet pressure placement signal, including alarms related to the Ao placement signal, will prevent calculation and display of an LV estimate. An operational Ao placement signal is required for the LV estimate



LV placement signal calibration is not available if the P-level is less than P-4 or if Suction, Placement Signal Not Reliable, or positioning alarms are active



Abnormal conditions, including cardiac arrhythmia, Ao-LV uncoupling, or aortic stenosis may limit the utility of the LV adjustment tool

ADJUST LV PLACEMENT SIGNAL

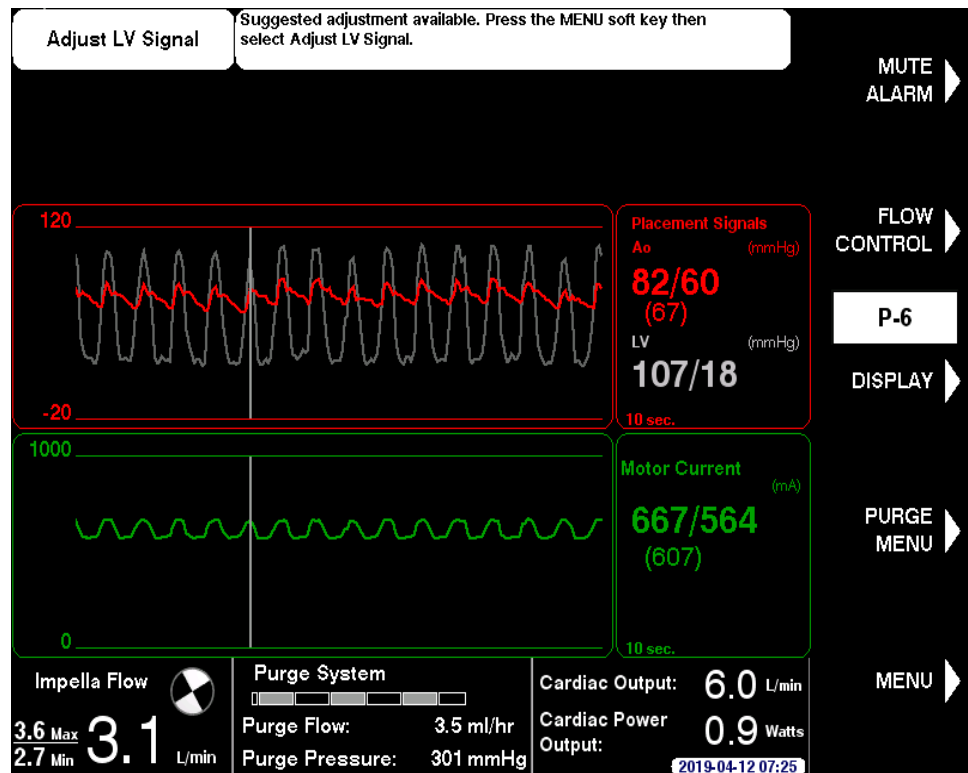

Figure 5.21 Adjust LV white notification

Adjust the LV placement signal to reduce potential measurement variability. Adjust the LV Placement Signal when the white notification appears on the screen.

To adjust LV Placement Signal:

1. Press the **MENU** soft buttons.
2. Select "Adjust LV Signal" option with rotary knob
3. Adjust the waveform using toggle arrows or rotary knob. The LV Adjustment defaults to the suggested adjustment value. The systolic upstroke phases of the LV and Ao placement signals must align.
4. Press **DONE** to confirm suggested adjustment. LV waveform adjustments occur in increments of 1 mmHg from -60 to 60 mmHg.

Recommended: Do not adjust to a value other than the suggested value.

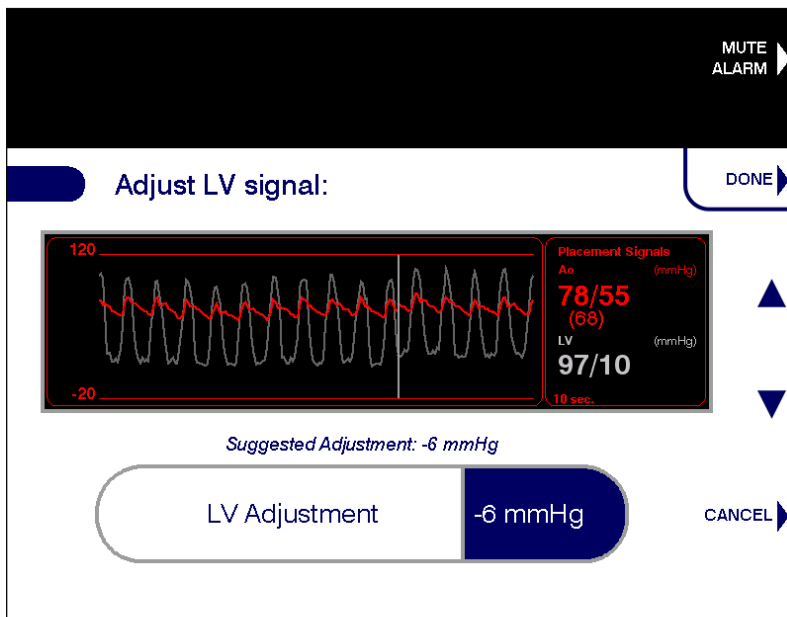

Figure 5.22 Pump Metrics IFU post-calibration in LV adjust tool

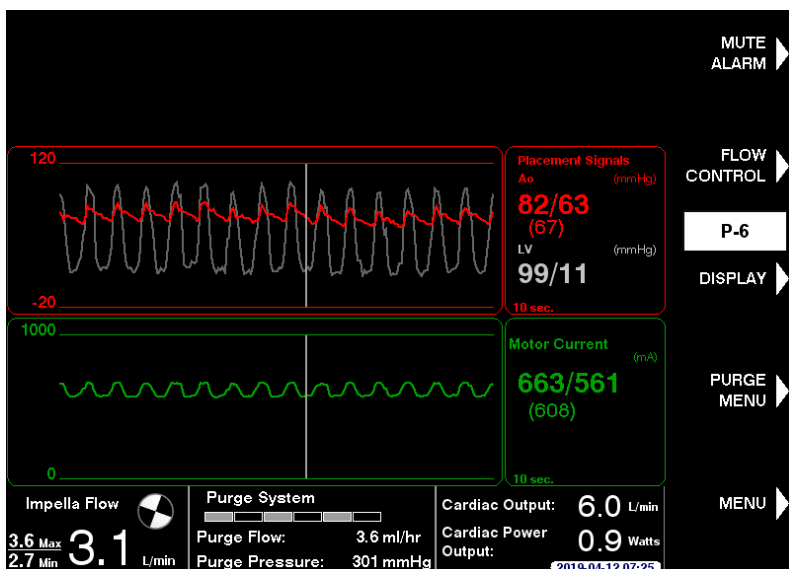

Figure 5.23 Pump Metrics IFU post-calibration placement screen

Note: It is not atypical to see a LV systolic value higher than the Ao systolic

ENTERING CARDIAC OUTPUT

The cardiac output and cardiac power output metrics are for informational purposes only. Do not use for diagnostic purposes or patient monitoring. Independently verify all parameters displayed with a cleared or approved diagnostic device. Enter cardiac output into the Automated Impella Controller from a reference device, such as a Swan-Ganz catheter. Enter a new cardiac output every 8 hours. After 7 hours from entry, a white notification will trigger to enter a new cardiac output. Refer to section 9 for information on accuracies.

TO ENTER CARDIAC OUTPUT

1. Press the **MENU** soft button.
2. Select the “Enter Cardiac Output” using the rotary knob.
3. Enter the total Cardiac Output, which can be any value from 0.0 to 10.0 L/min in increments of 0.1 L/min (Figure 5.24).
4. Press the **DONE** soft button or the rotary knob to complete.

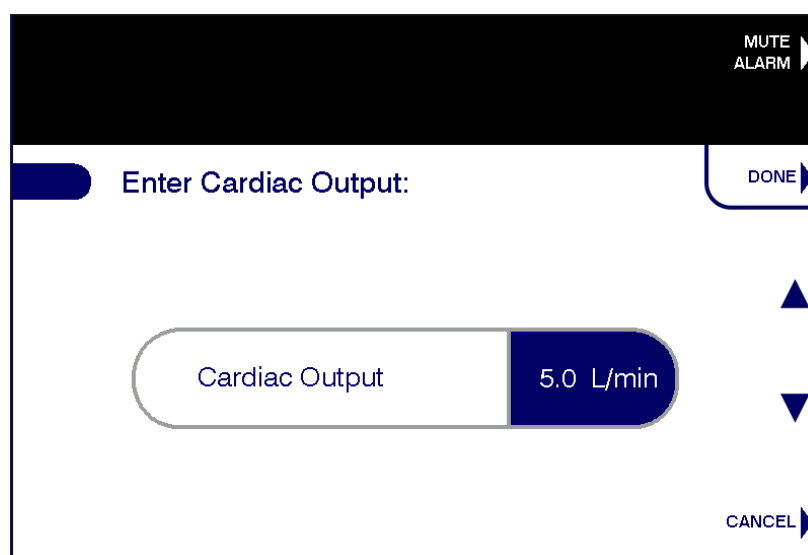

Figure 5.24 Pump Metrics IFU Enter Cardiac Output tool

Once a cardiac output is entered, the Automated Impella Controller calculates the Cardiac Power Output estimate with the following equation:

$$\text{CPO} = (\text{CO} \times \text{MAP}) \div 451$$

The timestamp in the cardiac output/cardiac power output area indicates when the last entry was made.

If a new entry is not made after 8 hours, values will show as dash marks until a new entry is made. A white reminder to update the CO will appear every 15 minutes for the last hour.

If cardiac power output values are below or equal to 0.6, the value will display as yellow.

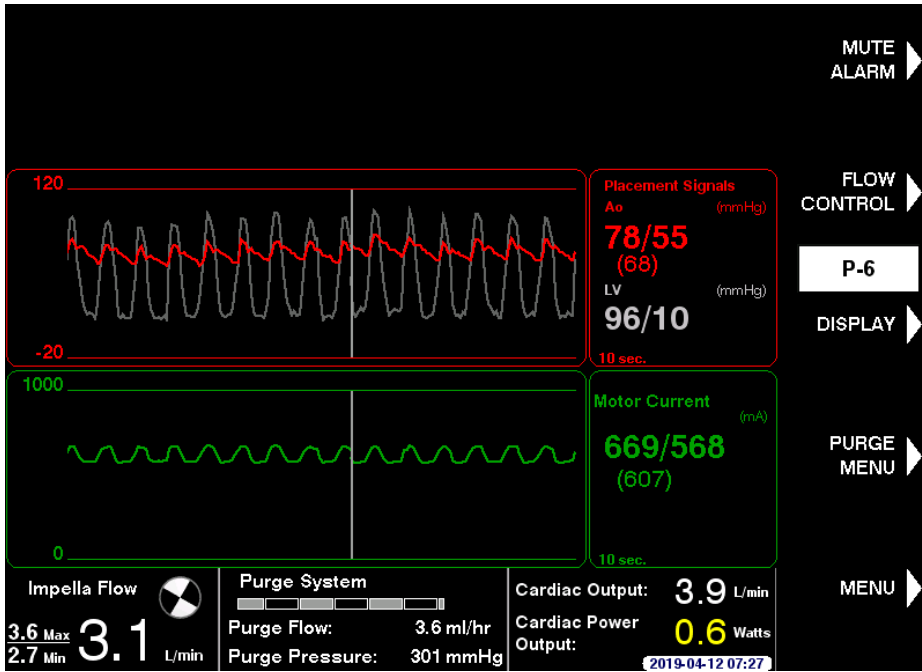

Figure 5.25 Pump Metrics IFU Yellow CPO

Note: Do not use values as a clinical diagnostic tool, this is for informational purposes only.

PURGE CASSETTE PROCEDURES



When replacing the purge cassette or purge fluid, the replacement process should be completed within 90 Seconds of disconnecting the luer. The Impella Catheter may be damaged if replacement takes longer than 90 Seconds of disconnecting the luer.

There are three procedures for maintaining the Impella Catheter purge system:

- Change cassette and purge fluid bag
- Change purge fluid bag
- De-Air purge system

Each procedure can be accessed using the **PURGE MENU** soft button. Transferring to the standard configuration was discussed above. The other three purge cassette procedures are discussed below.

CHANGE CASSETTE AND BAG

Purge cassette change out may be required if extended use of the Impella Catheter and purge cassette is required. Follow these steps to change both the purge cassette and purge fluid:

1. Press **PURGE MENU** and select "Change Cassette and Bag" from the menu.
2. Select **START** to begin the cassette and fluid change process.
3. When prompted by the controller, disconnect the luer from the Impella catheter.
4. Open the purge cassette door by pressing the button on the left side of the console. Remove and discard the old cassette and purge fluid bag.
5. Open the new purge cassette. Spike the new purge fluid bag with the new purge cassette tubing. Select **NEXT** to continue.
6. If included, disconnect and discard the Y Connector from the Purge Cassette Tubing. (See Figure 5.26)
7. Insert the new purge cassette into the controller. Be sure to slide the purge disc into place and extend the purge tubing through the gap in the purge cassette door when you close the door.

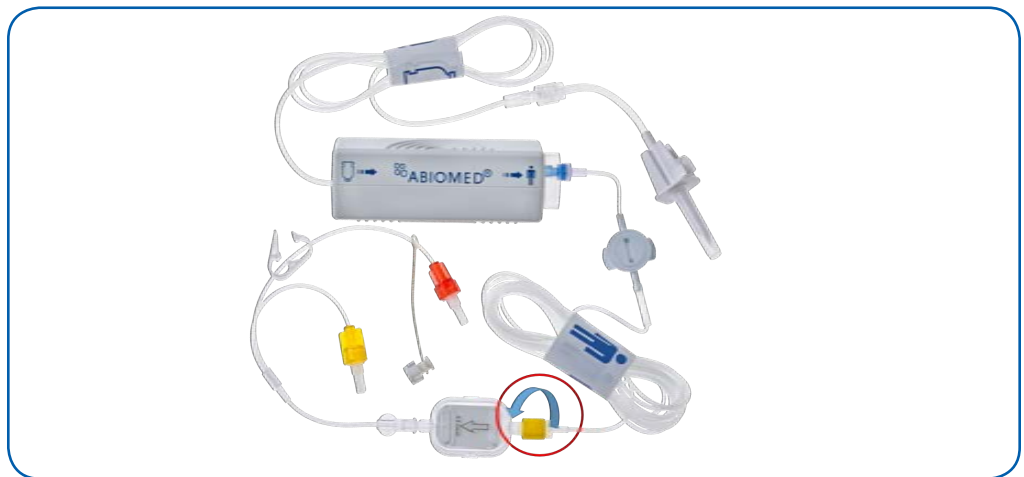

Figure 5.26 Disconnecting the Y Connector from the Purge Cassette Tubing

8. Confirm the luer is disconnected. Press **NEXT** to proceed to prime the purge cassette.
9. Update the purge fluid information.
 - a) To select the default purge fluid values displayed on the screen, select **CONFIRM**.
 - b) To change the purge fluid information, select **EDIT**. Then use the soft keys to navigate selections and edit values. Select **DONE** to complete editing.
10. When Steps 1 through 8 are complete, connect the luer from the new purge cassette to the Impella catheter.

CHANGE PURGE FLUID BAG

These are the steps you will follow to change only the purge fluid.

1. Press **PURGE MENU** and select "Change Purge Fluid Bag."
2. Select **START** to begin the purge fluid change process.
3. When prompted by the controller, remove the old purge bag and replace by spiking the new purge fluid bag. Select **NEXT** to advance to the next step.
4. Update the purge fluid information.
 - a) To select the default purge fluid values displayed on the screen, select **CONFIRM**.
 - b) To change the purge fluid information, select **EDIT**. Then use the soft keys to navigate selections and edit values. Select **DONE** to complete editing.
5. When prompted by the controller, disconnect the luer from the Impella Catheter. The controller will automatically prime the tubing, which will flush the fluid from the last bag out of the purge cassette tubing. **Note:** the instructions to disconnect the luer and to automatically prime the tubing only occurs if the user changed the purge fluid concentration
 - a) To skip the flush select **SKIP PRIME**.
6. When prompted by the controller, connect the yellow luer from the purge cassette to the Impella catheter.

Purge Solution Bottles

If the purge solution is supplied in bottles, open the vent on the purge fluid spike and follow the same procedure as if supplied in bags.

DE-AIR PURGE SYSTEM

These are the steps you will follow to de-air the purge system.

1. Press **PURGE MENU** and select "De-Air Purge System."
2. Select **START** to begin the de-air process.
3. Make sure that the purge fluid bag is NOT empty or inverted and that the tubing is NOT kinked. Select **NEXT** to continue.
4. Disconnect the purge tubing from the Impella Catheter.
5. Confirm that no air remains in the purge tubing. If air remains, press **BACK** to repeat the air removal process.
6. Connect the purge tubing to the luer on the Impella Catheter to complete the de-air procedure.

AIR DETECTED ALERT

During any of the purge system processes above, the controller automatically monitors for air in the system. If air is detected in the system, the controller provides an alert to disconnect the luer, as shown in Figure 5.27. Once the luer is disconnected, the controller automatically de-airs the purge system.



Figure 5.27 Air Detected Alert

TROUBLESHOOTING THE PURGE SYSTEM

PURGE PRESSURE LOW



If at any time during the course of support with the Impella Catheter, the Automated Impella Controller alarms “Purge Pressure Low,” follow the instructions below.

1. Inspect the purge system for leaks.
2. If there are no leaks, change to a purge fluid with a higher dextrose concentration. To do this, open the **PURGE MENU** and select “Change Purge Fluid Bag.” Follow the instructions on the screen. (Refer to “Purge Cassette Procedures” earlier in this section of the manual.)
3. If the pressure stabilizes, no other action is required.
If the purge pressure is not stable, proceed to Step 4.
4. If the low purge pressure alarm remains unresolved for more than 20 minutes, there may be a problem with the purge cassette. Replace the purge cassette. (Refer to “Change Cassette and Bag” instructions earlier in this section.)

PURGE SYSTEM BLOCKED

If the purge flow stops completely, the controller displays the “Purge System Blocked” alarm. For this event, follow these steps:

1. Inspect the purge system and check the Impella Catheter for kinks in the tubing.
2. Check the dextrose concentration of the purge fluid. Decrease the concentration to 5% if current concentration is higher
3. Replace the purge cassette using the Change Cassette and Bag procedure shown earlier in this section.
4. Monitor Motor Current.

PURGE SYSTEM OPEN



If at any time during the course of support with the Impella Catheter, the Automated Impella Controller alarms “Purge System Open,” follow the instructions below.

1. Inspect the purge system for leaks.
2. If no leaks are visible, there may be a problem with the purge cassette. Replace the purge cassette. (Refer to instructions earlier in this section of the manual.)

Purge System Open Alarm

This alarm may occur if purge pressure is less than 100 mmHg.

PATIENT WEANING

Weaning the patient from the Impella Catheter is at the discretion of the physician. The Impella 5.5 with SmartAssist has been approved for ≤ 14 days of use. However, weaning could be delayed beyond the normal use for temporary support as an unintended consequence of continued instability of the patient's hemodynamics. Inability to wean the patient from the device within a reasonable time frame should result in consideration of a more durable form of left ventricular support.

The following weaning instructions are provided as guidance only.

RAPID WEANING

1. Initiate rapid weaning by decreasing catheter P-level in 2-level steps at intervals of several minutes (for example, P-6 to P-4 to P-2). Do NOT decrease P-level to below P-2 until just before removing the catheter from the ventricle.
2. When the P-level has been reduced to P-2, maintain the patient on P-2 support for at least 10 minutes before discontinuing circulatory support.
3. If the patient's hemodynamics remain stable, decrease the P-level to P-1, pull the catheter into the aorta, and stop the motor by decreasing the P-level to P-0.
4. Explant the catheter.
5. Follow institutional guidelines for arterial closure.
6. Disconnect the connector cable from the Automated Impella Controller and turn the controller off by pressing the power switch on the side of the controller for 3 seconds.

SLOW WEANING

1. Initiate slow weaning by decreasing catheter P-level in 2-level steps over time as cardiac function allows (for example, P-6 to P-4 to P-2). Do NOT decrease P-level to below P-2 until just before removing the catheter from the ventricle.
2. When the P-level has been reduced to P-2, maintain the patient on P-2 support until the patient's hemodynamics remain stable before discontinuing circulatory support.
3. If the patient's hemodynamics remain stable, decrease the P-level to P-1, pull the catheter into the aorta, and stop the motor by decreasing the P-level to P-0.
4. Explant the catheter.
5. Follow institutional guidelines for arterial closure.
6. Disconnect the connector cable from the Automated Impella Controller and turn the controller off by pressing the power switch on the side of the controller for 3 seconds.

REMOVING THE IMPELLA 5.5 CATHETER

The Impella Catheter can be removed after weaning when the introducer is still in place or when the catheter is secured with the repositioning sheath.

REMOVING THE IMPELLA CATHETER WITH THE INTRODUCER IN PLACE

1. Reduce the P-level to P-0.
2. Remove the Impella Catheter through the introducer.
3. Wait until ACT drops below 150 seconds.
4. When ACT is below 150 seconds, remove the introducer.
5. Disconnect the connector cable from the Automated Impella Controller and turn the controller off by pressing the power switch on the side of the controller for 3 seconds.
6. Apply manual compression for 40 minutes or per hospital protocol.

REMOVING THE IMPELLA CATHETER SECURED WITH THE REPOSITIONING UNIT

1. When ACT is below 150 seconds, press **FLOW CONTROL** and reduce the P-level to P-0.
2. Remove the Impella Catheter and repositioning unit together (the catheter will not come through the repositioning unit).
3. Disconnect the connector cable from the Automated Impella Controller and turn the controller off by pressing the power switch on the side of the controller for 3 seconds.
4. Apply manual compression for 40 minutes or per hospital protocol.

VASCULAR GRAFT CLOSURE

When closing the vascular graft, consider individual patient characteristics and select the strategy most consistent with an optimal clinical result. The entire vascular graft can be removed if indicated, but it is not mandatory to do so. Graft closure options include:

- Amputating the vascular graft and sewing the small end-to-side remnant closed by hand
- Using a vascular stapler to close the graft near the surface of the aorta
- Removing the complete graft with local patch closure, if necessary

6 CLINICAL EXPERIENCE

CLINICAL EXPERIENCE OVERVIEW FOR HRPCI	6.1
PROTECT I CLINICAL STUDY	6.1
PROTECT II PIVOTAL CLINICAL STUDY DESIGN.....	6.2
External Evaluation Groups.....	6.3
Pre-specified Statistical Analysis Plan.....	6.3
Clinical Inclusion and Exclusion Criteria.....	6.4
ACCOUNTABILITY OF PROTECT II COHORT	6.6
Intent-to-Treat Population.....	6.6
Per-Protocol Analysis Population.....	6.6
LIMITATIONS OF INTERPRETATION OF STUDY RESULTS	6.7
STUDY POPULATION DEMOGRAPHICS AND BASELINE CHARACTERISTICS	6.7
PROCEDURAL CHARACTERISTICS	6.10
SAFETY AND EFFECTIVENESS RESULTS.....	6.13
Intent-to-Treat Population.....	6.14
Per-Protocol Analysis Population.....	6.14
Pre-Specified Subgroup Analysis on the Primary Endpoint.....	6.16
SECONDARY SAFETY RESULTS	6.20
SECONDARY EFFECTIVENESS RESULTS	6.21
Cardiac Power Output (CPO).....	6.21
Creatinine Clearance.....	6.21
Impella® Pump Output.....	6.21
IABP Pressure Augmentation	6.22
SUMMARY OF SUPPLEMENTAL CLINICAL INFORMATION	6.22
Further PROTECT II Analysis.....	6.22
USpella Registry - Impella 2.5	6.25
USpella Registry - Impella CP®	6.26
Clinical Outcomes Comparison	6.27
Left Ventricular Ejection Fraction (LVEF) Analysis	6.30
CONCLUSION.....	6.40
CLINICAL EXPERIENCE OVERVIEW FOR CARIOGENIC SHOCK AFTER ACUTE MYOCARDIAL INFARCTION OR OPEN HEART SURGERY.....	6.41
CARDIAC SHOCK AFTER ACUTE MYOCARDIAL INFARCTION - SUMMARY OF PRIMARY CLINICAL STUDIES	6.41
Prospective Randomized Trial: ISAR-SHOCK (for Impella 2.5).....	6.41
Clinical Inclusion and Exclusion Criteria.....	6.41
Clinical Endpoints.....	6.42

CLINICAL EXPERIENCE (CONTINUED)

Accountability of PMA cohort.....	6.43
Study Population Demographics and Baseline Parameters.....	6.43
Safety and Effectiveness Results.....	6.44
Device Failures and Replacements.....	6.46
Financial Disclosure.....	6.46
SUMMARY OF SUPPLEMENTAL CLINICAL INFORMATION.....	6.47
Real-World Impella Registry Results (for all Impella Devices).....	6.47
Additional Analysis of the Impella Registry Data.....	6.50
Benchmarking Impella vs. Approved VAD in AMICS.....	6.51
Hemodynamic Effectiveness Results.....	6.55
Literature Review.....	6.57
CARDIAC SHOCK AFTER OPEN HEART SURGERY - SUMMARY OF PRIMARY CLINICAL STUDIES.....	6.58
Clinical Inclusion and Exclusion Criteria.....	6.58
Clinical Endpoints.....	6.59
Accountability of PMA Cohort.....	6.60
Study Baseline Parameters.....	6.60
Safety and Effectiveness Results.....	6.62
Device Failures and Replacements.....	6.63
Financial Disclosure.....	6.63
SUMMARY OF SUPPLEMENTAL CLINICAL INFORMATION.....	6.64
Results.....	6.64
Hemodynamic Effectiveness Results.....	6.72
Literature Review.....	6.73
CLINICAL EXPERIENCE OVERVIEW FOR CARDIOGENIC SHOCK IN THE SETTING OF CARDIOMYOPATHY, MYOCARDITIS, AND PERIPARTUM CARDIOMYOPATHY.....	6.74
Impella Registry Results.....	6.74
Population Demographics and Baseline Characteristics.....	6.75
Impella Support Characteristics.....	6.77
Safety and Effectiveness Results.....	6.78
Patient Hemodynamics.....	6.81
In-Hospital Adverse Events.....	6.82
Relatedness to the Device and Procedure.....	6.83
Patient Survival at 30 Days.....	6.84
Summary of the Impella Registry Data.....	6.86
Device Failures and Replacements.....	6.86
Literature Review.....	6.87
Clinical Experience for Systemic Anticoagulation of Impella Patients Using Direct Thrombin Inhibitors.....	6.89.

CLINICAL EXPERIENCE OVERVIEW FOR HRPCL

The indication for use in high-risk PCI for the Impella 2.5® and the Impella CP® Systems were supported by US human clinical data, which includes an initial safety study (PROTECT I), a multi-center, prospective, randomized controlled clinical trial (PROTECT II) and data from a retrospective registry, USpella, along with literature reviews. Table 6.1 provides a summary of the evidence reviewed by the FDA for the high-risk PCI indication, which was the basis for the FDA's approval decision. Additional details for each study are provided below.

Table 6.1 Summary of Primary Clinical Studies Reviewed by the FDA (Prior to Approval)

Clinical Study	Study Design	Objective	Number of Sites	Number of Subjects
PROTECT I	Prospective, multi-center, single arm study	To examine the safety and feasibility of Impella 2.5 in patients undergoing high-risk angioplasty procedures	7	20 patients enrolled and available for 30-day follow up
PROTECT II	Prospective, multi-center, randomized controlled trial	To assess the safety and efficacy of the Impella 2.5 compared to intra-aortic balloon pump when used in subjects undergoing non-emergent high-risk PCI	112	452 patients enrolled; 448 patients in Intent-to-Treat population; 427 patients in Per-Protocol population
USpella Registry	Retrospective, multi-center voluntary registry	To examine the safety and effectiveness of the Impella 2.5 and the Impella CP when used in routine clinical practice for high-risk PCI	46	637 patients in high-risk PCI cohort for Impella 2.5
			18	72 patients in high-risk PCI cohort for Impella CP

PROTECT I CLINICAL STUDY

PROTECT I was a prospective, single arm, multi-center feasibility study designed under FDA guidance to examine the safety and feasibility of Impella 2.5 in patients undergoing high-risk angioplasty procedures. Patients presenting with a left ventricular ejection fraction (LVEF) $\leq 35\%$ and scheduled to undergo PCI on an unprotected left main lesion or last patent conduit were considered for enrollment. Safety endpoints included 30-day rate of major cardiac and cerebral events (MACCE) and other vascular, thromboembolic, and hemorrhagic safety endpoints. Efficacy endpoints included hemodynamic benefit and freedom from intra-procedural ischemia driven ventricular fibrillation or tachycardia requiring cardioversion. The study showed an excellent safety profile of the device when used as temporary ventricular support in high-risk PCI. The FDA reviewed this data in consideration for approval of the PROTECT II trial based on PROTECT I meeting its primary and secondary endpoints.

PROTECT II PIVOTAL CLINICAL STUDY DESIGN

The main clinical study (PROTECT II) was a prospective, multi-center, randomized, controlled clinical study. The objective of the PROTECT II study was to assess the safety and efficacy of the Impella 2.5 compared to the intra-aortic balloon pump (IABP) when used in subjects undergoing non-emergent high-risk PCI. The hypothesis of the study was to demonstrate that prophylactic use of Impella 2.5 was superior to IABP in preventing intra- and post-procedural major adverse events (MAE) in this patient population.

The pre-specified primary endpoint was a composite clinical endpoint of major adverse events (10 component major adverse event [MAE] rate) through 30 days or hospital discharge, whichever was longer, following the PCI procedure. The outcomes were to be compared to the control group treated with an intra-aortic balloon pump (IABP). To assess the durability of potential benefit (i.e., the primary endpoint), the same 10 component MAE rate was also evaluated at 90 days.

The secondary safety endpoints were the same 10 individual components of the composite primary clinical endpoint. Specifically, these were:

- Death
- Stroke/TIA
- Myocardial infarction
- Repeat revascularization
- Need for cardiac operation or thoracic or abdominal vascular operation or vascular operation for limb ischemia
- Acute renal dysfunction
- Cardiopulmonary resuscitation or ventricular arrhythmia requiring cardioversion
- Increase in aortic insufficiency by more than one grade
- Severe hypotension, defined as: systolic blood pressure or augmented diastolic pressure (whichever is greater) <90 mmHg for ≥5 min requiring inotropic/pressor medications or IV fluid
- Failure to achieve angiographic success defined as residual stenosis <30% after stent implantation.

Follow-up assessments were performed at 30 days or at discharge (whichever was longer), and at 90 days following the PCI procedure.

There were four secondary effectiveness endpoints:

- Maximum cardiac power output (CPO) decrease from baseline. CPO was defined as the product of simultaneously measured cardiac output (CO) and mean arterial pressure (MAP). The hypothesis was that the Impella 2.5 is superior to IABP in preserving hemodynamic status, defined by a lesser degree of CPO decrease during the high-risk PCI procedure.
- Creatinine clearance within 24 hours post procedure.
- Failure of the Impella 2.5 device to maintain a pump output of >1.0 L/min for more than five minutes while at a P-level P-5 or higher in the Impella® patients during the procedure.
- Failure of the IABP to augment diastolic pressure above the peak systolic pressure for more than five minutes in the IABP patients.

EXTERNAL EVALUATION GROUPS

The study was sponsored by Abiomed. The sponsor contracted with Harvard Clinical Research Institute (HCRI), an academic research organization to provide study management activities including randomization via Interactive Voice Recognition System (IVRS), site management, site monitoring, data management, statistical analysis, and oversight of safety processes including the Data Safety Management Board (DSMB) and the Clinical Events Committee (CEC).

The study included two independent Core Labs: Beth Israel Deaconess Medical Center Angiographic Core Laboratory, Boston, MA for angiographic analyses and Duke Clinical Research Institute, Durham, NC for echocardiographic analyses. The study protocol was approved by the sponsor, HCRI and the FDA. The protocol pre-specified an interim analysis with stopping rules and a Statistical Analysis Plan (SAP).

PRE-SPECIFIED STATISTICAL ANALYSIS PLAN

The pre-specified study hypothesis was that the Impella 2.5 would be superior to IABP in reducing the composite rate of intra- and post-procedural major adverse events (MAEs) at 30 days or hospital discharge, whichever is longer post index procedure.

The IABP was the *only* 510k cleared FDA device for cardiac support for high-risk PCI indication. Therefore, the IABP was chosen as the control device for PROTECT II.

The protocol stipulated that the detailed classification and description of the subgroup variables would be defined in the SAP. The following 4 subgroups were pre-specified in the SAP:

- Assessment of any potential learning curve effect: Evaluate the primary endpoint with and without the first Impella® case at each site in order to assess the impact of the learning curve for the protocol and for use of the device.
- Assessment of the primary endpoint for procedural characteristics or adjunctive therapies not equivalent between the two arms (i.e., rotational atherectomy).
- Assessment of the primary endpoint stratified by angioplasty indication (last remaining vessel/left main vs. triple vessel disease).
- Assessment of the primary endpoint stratified by the severity of the patient using the STS mortality risk score.

CLINICAL INCLUSION AND EXCLUSION CRITERIA

Patients enrolled in PROTECT II were considered at high-risk for hemodynamic instability during non-emergent percutaneous coronary intervention due to a combination of depressed left ejection fraction and complex coronary lesions and deemed to require prophylactic hemodynamic support by the treating physician. Patients were required to meet all inclusion criteria and none of the exclusion criteria in order to be enrolled in PROTECT II.

Inclusion Criteria

1. Signed Informed Consent
2. Subject is indicated for a non-emergent percutaneous treatment of at least one *de novo* or restenotic lesion in a native coronary vessel or bypass graft
3. Age eligible ($18 \leq \text{Age} \leq 90$)
4. Subject presents with:
 - a. Ejection Fraction $\leq 35\%$ AND at least one of the following criteria:
 - Intervention on the last patent coronary conduit, or
 - Intervention on an unprotected left main coronary artery
 - Or
 - b. Ejection Fraction $\leq 30\%$ and intervention in patient presenting with triple vessel disease

Three-vessel or triple vessel disease was defined as at least one significant stenosis (ie, $\geq 50\%$ stenosis by diameter) in all three major epicardial territories: left anterior descending artery (LAD) and/or side branch, left circumflex artery (LCX) and/or side branch, and right coronary artery (RCA) and/or side branch. In the case of left coronary artery dominance, a lesion in the LAD and the proximal LCX qualified as three-vessel disease.

Exclusion Criteria

1. ST Myocardial Infarction within 24 hours or CK-MB that have not normalized
2. Pre-procedure cardiac arrest within 24 hours of enrollment requiring CPR
3. Subject is in cardiogenic shock defined as:
 - $\text{CI} < 2.2 \text{ L/min/m}^2$ and $\text{PCWP} > 15 \text{ mmHg}$
 - Hypotension (systolic BP $< 90 \text{ mmHg}$ for >30 minutes or the need for supportive measures to maintain a systolic BP of greater than or equal to 90 mmHg) AND end organ hypoperfusion (cool extremities OR [a urine output of $< 30 \text{ mL/hour}$ AND a HR $> 60 \text{ BPM}$])
4. Mural thrombus in the left ventricle
5. The presence of a mechanical aortic valve or heart constrictive device
6. Documented presence of aortic stenosis (aortic stenosis graded as $\geq +2$ equivalent to an orifice area of 1.5 cm^2 or less)
7. Documented presence of moderate to severe aortic insufficiency (echocardiographic assessment of aortic insufficiency graded as $\geq +2$)
8. Severe peripheral arterial obstructive disease that would preclude the placement of the Impella® System or IABP device placement

9. Abnormalities of the aorta that would preclude surgery, including aneurysms and extreme tortuosity or calcifications
10. Subject with renal failure (creatinine ≥ 4 mg/dL)
11. Subject has history of debilitating liver dysfunction with elevation of liver enzymes and bilirubin levels to $\geq 3x$ ULN or Internationalized Normalized Ratio (INR) ≥ 2
12. Subject has uncorrectable abnormal coagulation parameters (defined as platelet count $\leq 75,000/\text{mm}^3$ or INR ≥ 2.0 or fibrinogen ≤ 1.50 g/L)
13. History of recent (within 1 month) stroke or TIA
14. Allergy or intolerance to heparin, aspirin, ADP receptor inhibitors (clopidogrel and ticlopidine) or contrast media
15. Subject with documented heparin induced thrombocytopenia
16. Participation in the active follow-up phase of another clinical study of an investigational drug or device

The study design is illustrated in Figure 6.1.

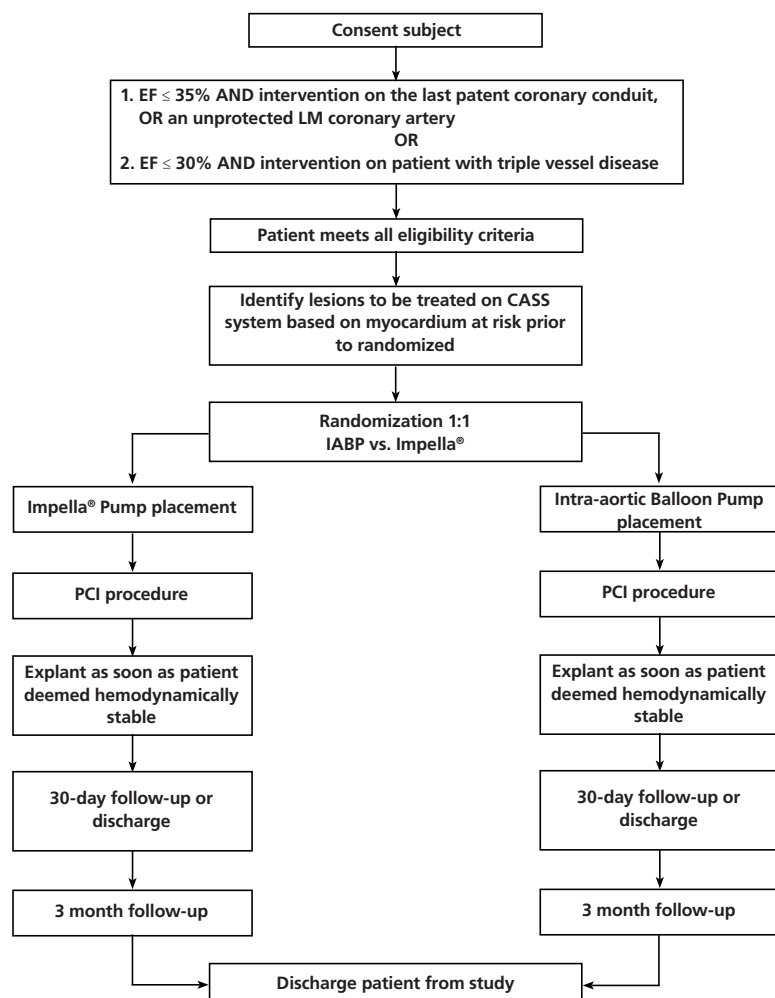

Figure 6.1 PROTECT II Study Schematic

ACCOUNTABILITY OF PROTECT II COHORT

A total of 452 subjects were enrolled into the trial: 226 subjects enrolled in the Impella® arm and 226 subjects enrolled in the IABP arm. This number represents 69% of the original planned enrollment (654 subjects). The PROTECT II trial was stopped prematurely by the company due to the Data Safety and Monitoring Board (DSMB) recommendation for futility after completing its pre-specified interim analysis at 50% enrollment for each group. More details are below.

INTENT-TO-TREAT POPULATION

Out of the 452 patients enrolled into the study, three subjects (all in IABP arm) withdrew consent before PCI and device insertion. One patient expired in the Impella® arm prior to undergoing PCI treatment and device insertion. Thus, the primary analysis includes 448 Intent-to-Treat (ITT) patients randomized to either Impella 2.5 (n=225) or IABP (n=223), regardless of whether or not they received the device and the duration of follow-up.

PER-PROTOCOL ANALYSIS POPULATION

Prior to accessing the data, the monitoring of the patient eligibility criteria by HCRI identified a total of twenty-one (21) subjects who did not meet the study inclusion or exclusion criteria. These cases were to be excluded from the ITT. The remainder formed the Per-Protocol (PP) population. Nine of the subjects excluded from the ITT population were in the Impella® arm and twelve subjects excluded from the ITT population were in the IABP arm. The PP analysis population consists then of 427 subjects, of which 216 subjects were randomized to the Impella® arm and 211 subjects were randomized to the IABP arm.

The study flow is represented in Figure 6.2 below, showing the ITT and PP populations and the sample sizes of each population at 30-day and 90-day follow-up.

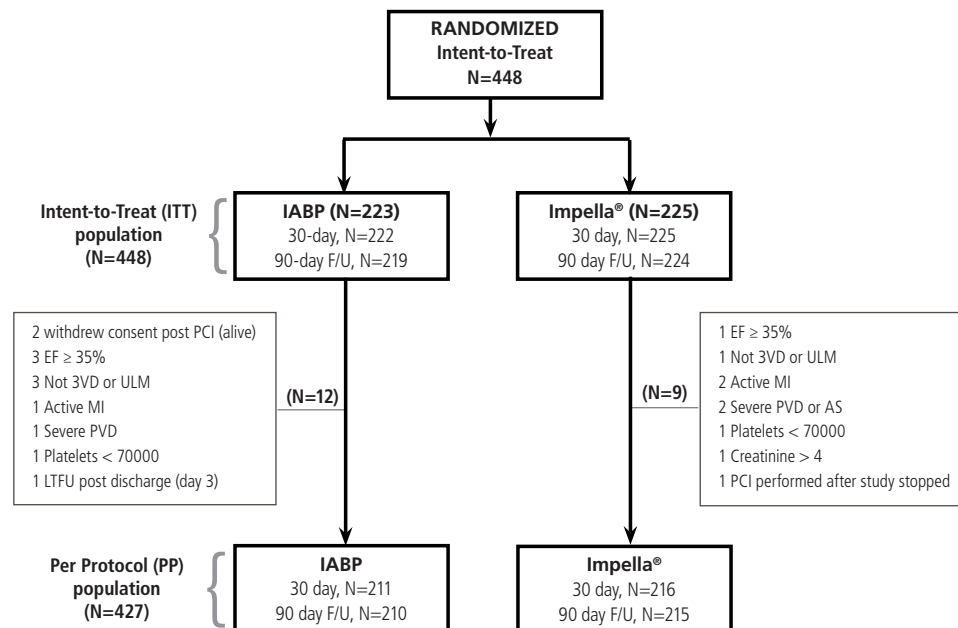

Figure 6.2 Study Flow Schematic

LIMITATIONS OF INTERPRETATION OF STUDY RESULTS

Fifty percent (50%) enrollment was achieved on February 26, 2010 with the enrollment of the 327th subject. This subject completed the study (3 month visit) on May 27, 2010. Approximately 7 months later, HCRI completed the study activities necessary to lock the database for the interim analysis and prepare an interim analysis report for the DSMB. In these 7 months of intervening time, 125 additional subjects were enrolled into the study (n=452). The results from the additional patients were excluded from the interim analysis.

The DSMB met on November 22, 2010 and recommended that the trial be halted due to a futility determination based on the pre-specified primary endpoint (composite MAE at 30 days), which was calculated on the first 327 patients enrolled in the study. The DSMB also expressed concern regarding safety trends identified in 3 of the pre-specified patient cohorts:

1. Patients receiving rotational atherectomy;
2. Patients undergoing PCI on an unprotected left main/last patent conduit;
3. Patients judged to be in the highest risk based on STS score

The study was formally ended on December 6, 2010, at which time the data were then unlocked.

STUDY POPULATION DEMOGRAPHICS AND BASELINE CHARACTERISTICS

Patient baseline characteristics for all enrolled patients (ITT N=448, 69% of planned cohort) are summarized in Table 6.2. Overall, patients had depressed ventricular function, multi-vessel disease (76% of patients), unprotected left main disease (24% of patients), and at least one of the following additional risk factors: advanced age, female, diabetes, peripheral vascular disease, history of angina, heart failure, or complex lesion anatomy (type B or C lesions).

Two thirds of the patients were deemed inoperable. Subjects presented with an average LVEF of $24\pm 6\%$, a SYNTAX score of 30 ± 13 , an STS mortality score of $6\pm 6\%$ and an STS combined mortality and morbidity score of $30\pm 15\%$. Only one-third of this population had received implantable defibrillators despite the low LVEF.

Of note, Impella® patients presented more frequently with chronic heart failure (91.1% vs. 83.4%,) and had more often prior CABG (38.2% vs. 28.7%,) compared to IABP patients, respectively.

Table 6.2 Patient Baseline Characteristics (ITT Population)

Patient Characteristics	All Patients (N=448)	Impella® Patients (N=225)	IABP Patients (N=223)
Age			
Mean±SD (N)	67.3±10.8 (448)	67.7±10.8 (225)	67.0±10.7 (223)
Range (Min, Max)	(37,90)	(40,90)	(37,90)
Gender - Male	80.4% (360/448)	79.6% (179/225)	81.2% (181/223)
Ethnicity and Race			
Hispanic/Latino	7.6% (34/448)	8.4% (19/225)	6.7% (15/223)
American Indian	0.4% (2/448)	0.9% (2/225)	0.0% (0/223)
Asian	2.7% (12/448)	1.3% (3/225)	4.0% (9/223)
African American	13.4% (60/448)	10.7% (24/225)	16.1% (36/223)
Hawaiian; Pacific Islander	0.7% (3/448)	0.4% (1/225)	0.9% (2/223)
Caucasian	78.8% (353/448)	83.1% (187/225)	74.4% (166/223)
Other	4.0% (18/448)	3.6% (8/225)	4.5% (10/223)
Weight (lbs)			
Mean±SD (N)	183.8±44.1 (448)	183.2±41.3 (225)	184.3±46.7 (223)
Range (Min, Max)	(99.0,417.0)	(100.0,320.0)	(99.0,417.0)
Height (in)			
Mean±SD (N)	67.7±3.7 (448)	67.8±3.7 (225)	67.6±3.7 (223)
Range (Min, Max)	(58.0,78.0)	(59.0,76.2)	(58.0,78.0)
Cardiac History			
CAD in a first degree relative	58.7% (237/404)	59.5% (119/200)	57.8% (118/204)
Prior Myocardial Infarction	67.6% (302/447)	69.2% (155/224)	65.9% (147/223)
History of Angina	66.3% (295/445)	69.5% (155/223)	63.1% (140/222)
CHF	87.3% (391/448)	91.1% (205/225)	83.4% (186/223)
NYHA Class III or IV	66.1% (222/336)	67.4% (120/178)	64.6% (102/158)
Pacemaker/AICD	32.9% (147/447)	34.7% (78/225)	31.1% (69/222)
Cardiomyopathy	69.2% (310/448)	69.3% (156/225)	69.1% (154/223)
Arrhythmia	48.9% (218/446)	50.9% (114/224)	46.8% (104/222)
Prior Cardiac Procedures			
Thrombolytic Therapy	5.7% (25/442)	4.9% (11/223)	6.4% (14/219)
PCI	39.2% (175/446)	41.5% (93/224)	36.9% (82/222)
CABG	33.5% (150/448)	38.2% (86/225)	28.7% (64/223)
Valve Surgery	3.3% (15/448)	3.1% (7/225)	3.6% (8/223)
Other Cardiac Surgery	7.2% (32/446)	6.3% (14/224)	8.1% (18/222)
Other Cardiac Intervention	14.8% (66/446)	14.3% (32/224)	15.3% (34/222)
CABG Evaluation:			
Subject was evaluated for CABG as treatment	64.1% (287/448)	63.6% (143/225)	64.6% (144/223)

Table 6.2 Patient Baseline Characteristics (ITT Population) (continued)

Patient Characteristics	All Patients (N=448)	Impella® Patients (N=225)	IABP Patients (N=223)
The reason for not performing CABG:			
Subject refused surgery	19.2% (55/287)	22.4% (32/143)	16.0% (23/144)
Subject not a candidate for CABG based on medical condition	80.8% (232/287)	77.6% (111/143)	84.0% (121/144)
Other Medical History:			
Peripheral Vascular Disease	26.1% (116/445)	25.7% (57/222)	26.5% (59/223)
Prior Stroke	14.7% (66/448)	12.9% (29/225)	16.6% (37/223)
Diabetes Mellitus	51.3% (230/448)	52.0% (117/225)	50.7% (113/223)
Hypertension	86.4% (387/448)	87.6% (197/225)	85.2% (190/223)
COPD	27.6% (123/445)	25.9% (58/224)	29.4% (65/221)
Renal Insufficiency	26.6% (119/447)	23.1% (52/225)	30.2% (67/222)
History of Tobacco Use	69.6% (307/441)	71.5% (158/221)	67.7% (149/220)
LVEF			
Mean±SD (N)	23.79±6.32 (445)	23.45±6.31 (224)	24.14±6.33 (221)
Range (Min, Max)	(10.00,35.00)	(10.00,35.00)	(10.00,35.00)
Mean±SD (N)	30.32±13.13 (144)	29.31±13.50 (157)	29.79±13.31 (301)
Range (Min, Max)	(5.00,68.50)	(3.00,85.50)	(3.00,85.50)
median (IQ Range)	30.50 (19.75-38.25)	28.00 (19.00-36.50)	29.00 (19.50-37.50)
STS Mortality Score			
Mean±SD (N)	5.93±6.48 (448)	5.86±5.98 (225)	6.01±6.97 (223)
Range (Min, Max)	(0.40,60.00)	(0.40,41.20)	(0.40,60.00)
STS Mortality and Morbidity Score			
Mean±SD (N)	29.52±15.34 (448)	28.80±14.97 (225)	30.24±15.71 (223)
Range (Min, Max)	(1.60,74.70)	(1.60,74.50)	(6.90,74.70)
Logistic EuroScore			
Mean±SD (N)	18.39±17.44 (448)	18.76±17.41 (225)	18.03±17.49 (223)
Range (Min, Max)	(0.82,94.53)	(0.82,94.53)	(1.33,91.15)

PROCEDURAL CHARACTERISTICS

In both study arms, more lesions were attempted than originally anticipated, as 27% of all patients had a lesion treated that was not identified as a target lesion in the pre-PCI revascularization treatment plan. The number of attempted lesions and deployed stents were similar between the two groups (Table 6.3).

Differences were observed between the two study arms with respect to the use of adjunctive therapies. In the Impella 2.5 arm, glycoprotein IIb/IIIa receptor antagonists were used less frequently, in 13.8% of Impella® patients vs. 26% of IABP patients. Rotational atherectomy was used more frequently in Impella® patients (14%) vs. IABP patients (9%). The use of rotational atherectomy was also more vigorous in the Impella® arm with more runs per patient ($p=0.003$), more passes per lesion ($p=0.001$), longer treatment durations ($p=0.004$) and more frequently performed in unprotected left main lesions. More stents were deployed in the Impella® arm compared to the IABP in patients that had atherectomy. Finally, the volume of contrast used was significantly greater in the Impella 2.5 arm. Patients randomized to IABP had longer duration of support compared with those on Impella 2.5 (8.4 hours vs. 1.9 hours). Instructions in the protocol called for device support to be discontinued after the PCI procedure if the patient was determined to be hemodynamically stable. In total, 36.7% of patients in the IABP arm required additional support post-PCI and were discharged from the catheterization laboratory (cath lab) on IABP support compared to 5.9% of patients in the Impella® arm, who were discharged from the cath lab on Impella® support.

Table 6.3 Procedural Characteristics

	All Patients (N=448)	Impella® Patients (N=225)	IABP Patients (N=223)
Lesion and Rotational Atherectomy Characteristic			
Number of lesions treated			
Mean±SD (N)	2.88±1.48 (448)	2.86±1.43 (225)	2.90±1.53 (223)
Range (Min, Max)	(1.00,8.00)	(1.00,8.00)	(1.00,8.00)
% Patients with at least one lesion treated that was not a target lesion for the procedure			
Percent	26.7% (119/446)	27.7% (62/224)	25.7% (57/222)
Number of stents placed			
Mean±SD (N)	3.01±1.83 (444)	3.07±1.77 (222)	2.94±1.90 (222)
Range (Min, Max)	(0.00,12.00)	(0.00,10.00)	(0.00,12.00)
Total of longest duration of coronary balloon inflation (second)			
Mean±SD (N)	58.23±93.67 (399)	63.86±125.69 (200)	52.58±41.17 (199)
Range (Min, Max)	(0.00,1500.00)	(0.00,1500.00)	(0.00,252.00)
% Patients with chronic total occlusion (CTO) lesions treated			
Percent	9.6% (43/448)	9.3% (21/225)	9.9% (22/223)
Use of atherectomy rotablation during index procedure			
Percent	11.6% (52/448)	14.2% (32/225)	9.0% (20/223)
Total number of passes when atherectomy was used			
Median (IQ Range)	4.00 (2.00 - 8.00)	5.00 (3.50 - 9.50)	2.00 (2.00 - 4.00)
Average number of passes per lesion when atherectomy was used			
Median (IQ Range)	2 (1 - 4)	3 (2 - 5)	1 (1 - 2)

Table 6.3 Procedural Characteristics (continued)

	All Patients (N=448)	Impella® Patients (N=225)	IABP Patients (N=223)
Average duration/run time per lesion when atherectomy was used (second)			
Median (IQ Range)	47.50 (32.50 - 85.00)	60.00 (40.00 - 118.00)	40.00 (20.00 - 47.00)
Average number of stents placed when atherectomy was used			
Mean±SD (N)		3.44±1.61 (32) (1.00 – 8.0)	2.50±1.40 (20) (0.0 – 6.0)
Procedural Characteristics			
Volume for contrast administered during the index procedure (cc)			
Mean±SD (N)	253.86±129.26 (443)	266.73±141.80 (222)	240.94±114.17 (221)
Range (Min, Max)	(40.00,970.00)	(40.00,970.00)	(50.00,700.00)
Duration of device support (hour)			
Mean±SD (N)	5.12±15.81 (439)	1.87±2.69 (221)	8.41±21.81 (218)
Range (Min, Max)	(0.20,199.32)	(0.28,26.38)	(0.20,199.32)
Device support continued more than 3 hours post index procedure			
Percent	16.6% (73/440)	4.5% (10/221)	28.8% (63/219)
Patients discharged from cath lab on device support			
Percent	21.2% (93/438)	5.9% (13/220)	36.7% (80/218)
IV fluid volume subject received during procedure (cc)			
Mean±SD (N)	486.10±518.26 (338)	555.65±623.07 (168)	417.38±377.38 (170)
Range (Min, Max)	(0,5000)	(0,5000)	(0,2250)
Heparin administered during procedure			
Percent	88.4% (395/447)	93.3% (210/225)	83.3% (185/222)
IIb/IIIa inhibitors used at baseline			
Percent	19.9% (89/448)	13.8% (31/225)	26.0% (58/223)
Periprocedural transfusion required			
Percent	2.7% (12/447)	3.6% (8/224)	1.8% (4/223)
Number of units transfused during the procedure or at pump removal combined			
Mean±SD (N)	2.42±1.44 (12)	2.25±1.49 (8)	2.75±1.50 (4)
Range (Min, Max)	(1.00,5.00)	(1.00,5.00)	(2.00,5.00)
Impella® Pump flow during procedure (L/min)			
Mean±SD (N)	1.90±0.27 (217)	1.90±0.27 (217)	N/A
Range (Min, Max)	(1.10,2.50)	(1.10,2.50)	

SAFETY AND EFFECTIVENESS RESULTS

As discussed above, the pre-specified primary endpoint for the PROTECT II study was a 30-day composite MAE rate (10 components), where the study hypothesis was to demonstrate that prophylactic use of Impella 2.5 was superior to IABP in preventing intra- and post-procedural MAEs in this patient population. A pre-specified interim look by the Data Safety Monitoring Board (DSMB) at 50% enrollment (327 patients) concluded in a recommendation for early discontinuation of the study for futility as the “Board found no statistically significant differences in major adverse events” between the Impella® and IABP arms, with some identified safety concerns as well.

Abiomed formally terminated the study on December 6, 2010, at which point they unlocked all of the data (n=452) and performed additional analyses on the total cohort of patients enrolled into the PROTECT II study and available for analysis (n=448; 225 Impella® subjects and 223 IABP subjects). These analyses concluded the following:

1. There was an imbalance between the two groups in the use of rotational atherectomy—more frequent and more vigorous in the Impella® arm as compared to IABP.
2. The analysis of the data available for the 448 patient cohort (69% of planned enrollment) did not appear consistent with the futility statements made by the DSMB which were based on a review of 327 patients (50% enrollment).
3. Some of the negative trends in outcomes for the Impella® arm observed at interim appear to be attenuated when the totality of the data was reviewed.
4. Contrary to the interim assumption, the analysis that includes the full patient cohort suggests that Impella 2.5 outcomes improved over the course of the trial (i.e., from 30-day follow-up to 90-day follow-up), while the outcomes for the IABP arm appear to remain about the same between the two follow-up periods.

These findings, in addition to the possibility that a learning curve was present and may have skewed the results of early interventions, led FDA to consider the possibility that the treatment effect may simply not have been realized in this terminated study. As such, the FDA review of PMA P140003 included the totality of all data available (descriptive only) for the Impella 2.5 System (when used in HRPCI patients) in its evaluation of the safety and effectiveness of the Impella 2.5 System when used as intended. The primary data set utilized for this evaluation came from the 452 patients enrolled into the PROTECT II study (30-day and 90-day data), as well as supporting/supplemental evidence from the literature and data from the USpella Registry.

The 10 component composite MAE rate (summarized in Table 6.4a and 6.4b) showed a numerical difference at 30 days in both the ITT and PP populations at 69% of the planned enrollment in favor of Impella®. The numerical difference in MAE rates between the two groups, increases at 90 days for the PP population (the longest study follow-up).

INTENT-TO-TREAT POPULATION

At 69% of the planned enrollment, the 30-day MAE rate was 35.1% in the Impella® arm compared to 40.1% in the IABP arm (Table 6.4a and Figure 6.3). The 90-day MAE rate showed trends in favor of Impella® (40.6% vs. 49.3%, Table 6.4a, see Figure 6.3).

PER-PROTOCOL ANALYSIS POPULATION

At 69% enrollment, 30-day MAE rate was 34.3% in the Impella® arm compared to 42.2% in the IABP arm. Compared with IABP, the 90-day MAE rate was lower in the Impella® arm (40.0% vs. 51.0%) yielding a relative risk reduction of 22% (Table 6.4b and Figure 6.4). The Kaplan-Meier analysis (Figure 6.4) and the log-rank test through 90 days supports this result.

Table 6.4a Composite MAE at 30 Days and 90 Days (Intent-to-Treat Population)

Composite MAE (ITT Population)	Impella® Patients	IABP Patients	Difference	Relative Reduction or Increase
30 days or Discharge	35.1% (79/225)	40.1% (89/222)	- 5.0%	- 12.5%
90-day follow-up	40.6% (91/224)	49.3% (108/219)	- 8.7%	- 17.6%

Table 6.4b Composite MAE at 30 Days and 90 Days (Per-Protocol Population)

Composite MAE (PP Population)	Impella® Patients	IABP Patients	Difference	Relative Reduction or Increase
30 days or Discharge	34.3% (74/216)	42.2% (89/211)	- 7.9%	- 18.7%
90-day follow-up	40.0% (86/215)	51.0% (107/210)	- 11.0%	- 21.6%

ITT	Time after Initial Procedure (days)			
	0	30	60	90
Impella® Patients At Risk	225	168	145	120
IABP Patients At Risk	223	171	133	107

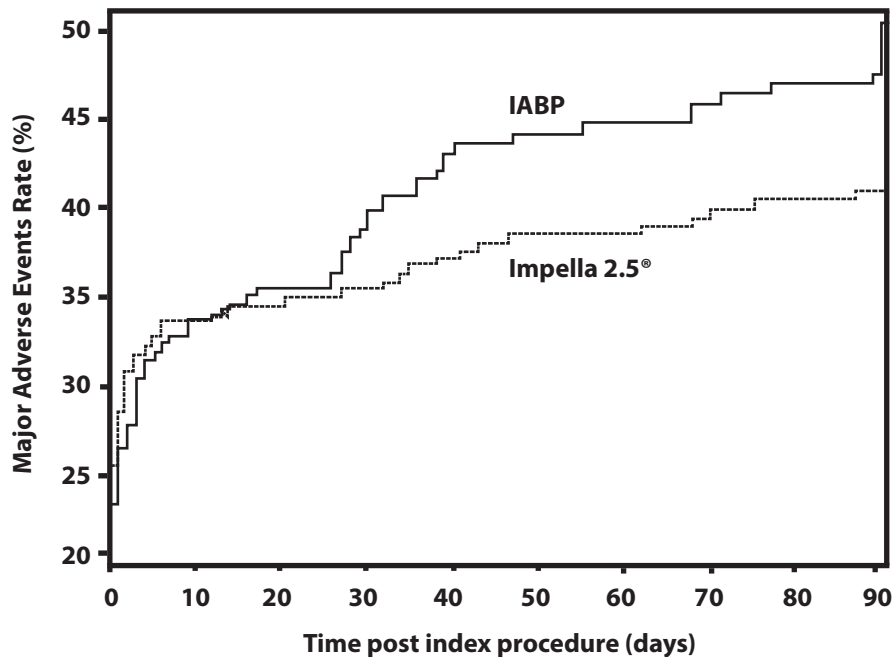

Figure 6.3 Kaplan-Meier Curves for Major Adverse Events (Intent-to-Treat Population)

PP	Time after Initial Procedure (days)			
	0	30	60	90
Impella® Patients At Risk	216	163	141	116
IABP Patients At Risk	211	160	124	99

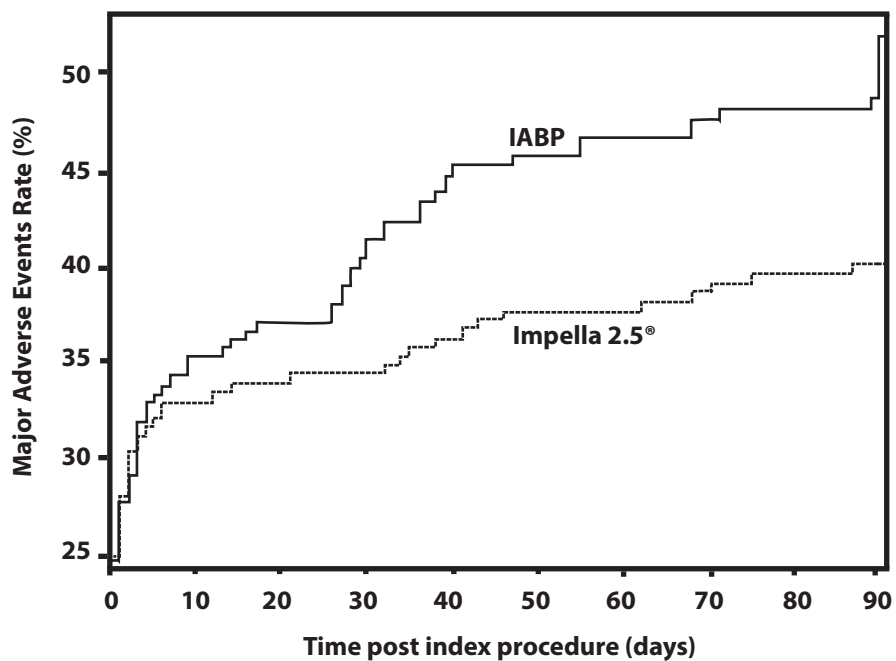

Figure 6.4 Kaplan-Meier Curves for Major Adverse Events (Per-Protocol Population)

PRE-SPECIFIED SUBGROUP ANALYSIS ON THE PRIMARY ENDPOINT

Learning Curve

The results of the pre-specified analysis without the Impella® roll-in subject suggested the presence of a learning curve in the trial. Patients in the Impella® arm, with the first subject excluded, had fewer MAEs at 30 days compared to the 30-day rate that was observed for all Impella® patients (Tables 6.5a and 6.5b). This had the effect of enlarging the observed differences in MAE rates at 30 and 90 days when comparing the adjusted Impella® cohort to IABP (Tables 6.5a and 6.5b).

Table 6.5a Subgroup Without Impella® Roll-In Subject (Intent-to-Treat Population)

Subgroup Analysis– Without Impella® Roll-In Subject (ITT)	Impella® Patients (N=167)	IABP Patients (N=223)	Difference	Relative Reduction or Increase
30 days or Discharge	31.7%	40.1%	- 8.4%	- 20.9%
90-day follow-up	38.0%	49.3%	- 11.3%	- 22.9%

Table 6.5b Subgroup Without Impella® Roll-In Subject (Per-Protocol Population)

Subgroup Analysis– Without Impella® Roll-In Subject (PP)	Impella® Patients (N=162)	IABP Patients (N=211)	Difference	Relative Reduction or Increase
30 days or Discharge	32.1%	42.2%	- 10.1%	- 23.9%
90-day follow-up	38.5%	51.0%	- 12.5%	- 24.5%

Atherectomy / Non-atherectomy

Atherectomy was not used as a part of the PCI procedure in 88% of the enrolled patients. In this subgroup, a relative reduction of MAE risk for ITT patients at 30 days favoring Impella 2.5 that was similar in magnitude to the reduction observed when the first Impella® patient was removed was observed at 30 days. Relative reductions in the MAE rate for PP treated patients were observed at 30 and 90 days (Tables 6.6a and 6.6b).

Table 6.6a Subgroup Without Rotational Atherectomy (Intent-to-Treat Population)

Subgroup Analysis– No Rotational Atherectomy (ITT)	Impella® Patients (N=193)	IABP Patients (N=203)	Difference	Relative Reduction or Increase
30 days or Discharge	30.6%	39.6%	- 9.0%	- 22.7%
90-day follow-up	38.5%	48.7%	- 10.2%	- 20.9%

Table 6.6b Subgroup Without Rotational Atherectomy (Per-Protocol Population)

Subgroup Analysis– No Rotational Atherectomy (PP)	Impella® Patients (N=184)	IABP Patients (N=191)	Difference	Relative Reduction or Increase
30 days or Discharge	29.3%	41.9%	- 12.6%	- 30.1%
90-day follow-up	35.5%	50.5%	- 15.0%	- 29.7%

An analysis of the composite MAE for the subjects treated with rotational atherectomy is summarized in Tables 6.7a (ITT population) and 6.7b (PP population). This was a small subgroup consisting of 32 Impella® subjects and 20 IABP subjects in the ITT and PP groups. There was a numerically higher observed rate of MAE in Impella® subjects compared to IABP treated with rotational atherectomy for both the ITT and PP populations.

Table 6.7a Subgroup With Rotational Atherectomy (Intent-to-Treat Population)

Subgroup Analysis– With Rotational Atherectomy (ITT)	Impella® Patients (N=32)	IABP Patients (N=20)	Difference	Relative Reduction or Increase
30 days or Discharge	62.5%	45.0%	+ 17.5%	+ 38.9%
90-day follow-up	65.6%	55.0%	+ 10.6%	+ 19.3%

Table 6.7b Subgroup With Rotational Atherectomy (Per-Protocol Population)

Subgroup Analysis– With Rotational Atherectomy (PP)	Impella® Patients (N=32)	IABP Patients (N=20)	Difference	Relative Reduction or Increase
30 days or Discharge	62.5%	45.0%	+ 17.5%	+ 38.9%
90-day follow-up	65.6%	55.0%	+ 10.6%	+ 19.3%

Angioplasty Indication

An analysis of the composite MAE for the subgroup whose indication for angioplasty was unprotected left main or last patent coronary conduit (24% of the entire PROTECT II cohort) is summarized in Tables 6.8a and 6.8b (ITT and PP populations respectively).

The composite MAE rate was similar between the study arms at 30 days in the ITT group (41.5% for Impella® vs. 40.7% for IABP). There were numerically fewer MAEs in the Impella® arm compared to the IABP arm in the ITT population (44.2% vs. 50.0%) and PP population (41.7% vs. 50.9%) at 90 days.

Table 6.8a Subgroup of Unprotected Left Main / Last Patent Conduit (Intent-to-Treat Population)

Subgroup Analysis– Unprotected Left Main (ITT)	Impella® Patients (N=53)	IABP Patients (N=54)	Difference	Relative Reduction or Increase
30 days or Discharge	41.5%	40.7%	+0.8%	+2.0%
90-day follow-up	44.2%	50.0%	- 5.8%	- 11.6%

Table 6.8b Subgroup of Unprotected Left Main / Last Patent Conduit (Per-Protocol Population)

Subgroup Analysis– Unprotected Left Main (PP)	Impella® Patients (N=49)	IABP Patients (N=53)	Difference	Relative Reduction or Increase
30 days or Discharge	38.8%	41.5%	- 2.7%	- 6.5%
90-day follow-up	41.7%	50.9%	- 9.2%	- 18%

An analysis of the composite MAE for the subgroup whose indication for angioplasty was three-vessel disease is summarized in Tables 6.9a (ITT population) and 6.9b (PP population). The observed composite MAE rate was numerically lower for Impella® vs. IABP at 30 and 90 days in the ITT group. In the Per-Protocol population, a trend in favor of Impella® was observed at 90 days (39.5% MAE for Impella® vs. 51.0% MAE for IABP).

Table 6.9a Subgroup of Three Vessel Disease (Intent-to-Treat Population)

Subgroup Analysis– Three Vessel Disease (ITT)	Impella® Patients (N=169)	IABP Patients (N=172)	Difference	Relative Reduction or Increase
30 days or Discharge	33.1%	39.9%	- 6.8%	- 17.0%
90-day follow-up	39.5%	49.1%	- 9.6%	- 19.6%

Table 6.9b Subgroup of Three Vessel Disease (Per-Protocol Population)

Subgroup Analysis– Three Vessel Disease (PP)	Impella® Patients (N=158)	IABP Patients (N=167)	Difference	Relative Reduction or Increase
30 days or Discharge	32.9%	42.4%	- 9.5%	- 22.4%
90-day follow-up	39.5%	51.0%	- 11.5%	- 22.5%

Outcomes as a Function of Morbidity: STS Mortality Score

An analysis of the composite MAE for the subgroup with STS mortality scores < 10 is summarized in Tables 6.10a (ITT population) and 6.10b (PP population). The composite MAE rate in the ITT group is numerically lower for Impella® vs. IABP at 30 days (33.2% for Impella® vs. 38.7% for IABP) and at 90 days (37.4% for Impella® vs. 48.6% for IABP). In the PP population, there was a numerical trend favoring Impella® at 90 days (36.1% MAE for Impella® vs. 50.6% MAE for IABP).

Table 6.10a Subgroup of STS Mortality Score <10 (Intent-to-Treat Population)

Subgroup Analysis– STS Mortality Score <10 (ITT)	Impella® Patients (N=187)	IABP Patients (N=187)	Difference	Relative Reduction or Increase
30 days or Discharge	33.2%	38.7%	- 5.5%	- 14.2%
90-day follow-up	37.4%	48.6%	- 11.2%	- 23.0%

Table 6.10b Subgroup of STS Mortality Score <10 (Per-Protocol Population)

Subgroup Analysis– STS Mortality Score <10 (PP)	Impella® Patients (N=180)	IABP Patients (N=175)	Difference	Relative Reduction or Increase
30 days or Discharge	31.7%	41.1%	- 9.4%	- 22.9%
90-day follow-up	36.1%	50.6%	- 14.5%	- 28.7%

An analysis of the composite MAE for the subgroup with STS mortality scores ≥ 10 is summarized in Tables 6.11a (ITT population) and 6.11b (PP population). This subgroup represents the highest-risk patients enrolled in the trial. The composite MAE rate is similar for Impella® vs. IABP at 30 days in the ITT group (44.7% for Impella® vs. 47.2% for IABP) and the PP population (47.2% for Impella® vs. 47.2% for IABP). The rates remain similar between the two arms at 90 days for both the ITT (56.8% for Impella® vs. 52.8% for IABP) and PP populations (60.0% for Impella® vs. 52.8% for IABP).

Table 6.11a Subgroup of STS Mortality Score ≥ 10 (Intent-to-Treat Population)

Subgroup Analysis– STS Mortality Score ≥ 10 (ITT)	Impella® Patients (N=38)	IABP Patients (N=36)	Difference	Relative Reduction or Increase
30 days or Discharge	44.7%	47.2%	- 2.5%	- 5.3%
90-day follow-up	56.8%	52.8%	+ 4.0%	+ 7.6%

Table 6.11b Subgroup of STS Mortality Score ≥ 10 (Per-Protocol Population)

Subgroup Analysis– STS Mortality Score ≥ 10 (PP)	Impella® Patients (N=36)	IABP Patients (N=36)	Difference	Relative Reduction or Increase
30 days or Discharge	47.2%	47.2%	0%	0%
90-day follow-up	60.0%	52.8%	+ 7.2%	+ 13.6%

The above results show that: 1) patients supported with Impella® tend to have a lower composite MAE rate than those supported with IABP in most of the subgroups; 2) there appears to be a learning curve associated with the use of the device that can be seen when removing from the analysis the first Impella® subject at each site, and 3) the use of atherectomy appears to be potentially a confounding variable that may have affected the results of the trial (including the high STS group patient subgroup).

SECONDARY SAFETY RESULTS

The ten major adverse events components of the primary endpoint were analyzed separately, in both a non-hierarchical and hierarchical manner. Tables 6.12a and 6.12b summarize the individual major adverse events components in a non-hierarchical manner, in which all the MAEs for all the subjects are represented in the components. Table 6.12a gives the results for the MAE components for the Intent-to-Treat population to 30 days or discharge, whichever is longer, and at 90 days. None of the differences between the IABP and Impella® study arms for the individual MAE components were numerically different at any time point for the ITT with the exception of repeat revascularization at 90 days, where 26 IABP subjects vs. 14 Impella® subjects required repeat revascularization.

Table 6.12b summarizes the results for the MAE components for the Per-Protocol population to 30 days or discharge, whichever was longer, and at 90 days. None of the numerical differences between the study arms for the individual MAE components days were significant at any point with the exception of repeat revascularization at 90 days, where 26 IABP subjects vs. 13 Impella® subjects required repeat revascularization.

Table 6.12a Individual MAE Components (ITT Population) Non-Hierarchical

MAE to 30 Days or Discharge	30 Days		90 Days	
	Impella® Patients (N=225)	IABP Patients (N=222)	Impella® Patients (N=224)	IABP Patients (N=219)
Death	7.6% (17/225)	5.9% (13/222)	12.1% (27/224)	8.7% (19/219)
Stroke/TIA	0.4% (1/225)	1.8% (4/222)	1.3% (3/224)	2.7% (6/219)
Myocardial Infarction	17.8% (40/225)	12.2% (27/222)	18.8% (42/224)	16.0% (35/219)
Repeat Revascularization	3.6% (8/225)	5.9% (13/222)	6.3% (14/224)	11.9% (26/219)
Need for Cardiac or Vascular Operation or Limb Ischemia	1.8% (4/225)	2.3% (5/222)	2.2% (5/224)	3.7% (8/219)
Acute Renal Dysfunction	7.1% (16/225)	7.7% (17/222)	9.4% (21/224)	11.0% (24/219)
CPR or Ventricular Arrhythmia Requiring Cardioversion	10.2% (23/225)	7.2% (16/222)	12.5% (28/224)	10.0% (22/219)
Increase in Aortic Insufficiency	0.0% (0/225)	0.0% (0/222)	0.0% (0/224)	0.0% (0/219)
Severe Hypotension	10.7% (24/225)	11.7% (26/222)	10.7% (24/224)	11.9% (26/219)
Angiographic Failure	3.6% (8/225)	1.8% (4/222)	3.6% (8/224)	1.8% (4/219)

Table 6.12b Individual MAE Components (PP Population) Non-Hierarchical

MAE to 30 Days or Discharge	30 Days		90 Days	
	Impella® Patients (N=216)	IABP Patients (N=211)	Impella® Patients (N=215)	IABP Patients (N=210)
Death	6.9% (15/216)	6.2% (13/211)	11.6% (25/215)	9.0% (19/210)
Stroke/TIA	0.5% (1/216)	1.9% (4/211)	1.4% (3/215)	2.4% (5/210)
Myocardial Infarction	17.1% (37/216)	12.8% (27/211)	18.1% (39/215)	16.7% (35/210)
Repeat Revascularization	3.2% (7/216)	6.2% (13/211)	6.0% (13/215)	12.4% (26/210)
Need for Cardiac or Vascular Operation or Limb Ischemia	1.9% (4/216)	2.4% (5/211)	2.3% (5/215)	3.8% (8/210)
Acute Renal Dysfunction	7.4% (16/216)	8.1% (17/211)	9.8% (21/215)	11.4% (24/210)
CPR or Ventricular Arrhythmia Requiring Cardioversion	9.7% (21/216)	7.6% (16/211)	12.1% (26/215)	10.5% (22/210)
Increase in Aortic Insufficiency	0.0% (0/216)	0.0% (0/211)	0.0% (0/215)	0.0% (0/210)
Severe Hypotension	10.2% (22/216)	12.3% (26/211)	10.2% (22/215)	12.4% (26/210)
Angiographic Failure	3.7% (8/216)	1.9% (4/211)	3.7% (8/215)	1.9% (4/210)

SECONDARY EFFECTIVENESS RESULTS

CARDIAC POWER OUTPUT (CPO)

When measured by maximal drop in CPO from baseline, Impella® appeared to provide better hemodynamic support compared to IABP (-0.04 ± 0.24 vs. -0.14 ± 0.27 Watts, respectively).

CREATININE CLEARANCE

The mean change in creatinine clearance from baseline to 24 hours post-procedure was equivalent for the two study arms: 4.64 ± 15.06 mL/min for the Impella® arm and 4.66 ± 13.55 mL/min for the IABP arm.

IMPELLA® PUMP OUTPUT

A secondary effectiveness endpoint was defined as the failure of the Impella 2.5 device to maintain a pump output of > 1.0 L/min for more than five minutes while at a performance level P-5 or higher in the Impella® patients during the procedure. Analysis of the data of flow vs. P-level for Impella® subjects showed no failures (0%). In all cases the Impella 2.5, when set at performance level P-5 or higher, was able to maintain flows above 1.0 L/min.

IABP PRESSURE AUGMENTATION

A secondary effectiveness endpoint was the failure of the IABP to augment diastolic pressure above the peak systolic pressure for more than five minutes in the IABP patients. This endpoint was unable to be measured for the study, as the data analysis required access to IABP console data, which was not possible without the IABP manufacturer's approval. Alternative sources of data (i.e., analysis of IABP device failures and the MAE rate for hypotension for the IABP arm) do not suggest that there would have been significant failures of the IABP to augment diastolic pressure above the peak systolic pressure for more than five minutes in the IABP patients.

SUMMARY OF SUPPLEMENTAL CLINICAL INFORMATION

FURTHER PROTECT II ANALYSIS

An additional *post hoc* analysis was conducted on the primary endpoint of the PROTECT II data set and provided additional clinical information.

This analysis used a different, prognostically relevant definition of peri-procedural myocardial infarction. Specifically, the 2007 universal definition of MI used in the trial has since changed to reflect current knowledge. The additional analysis incorporated the identical data from PROTECT II, but was conducted using an 8x Upper Limit of Normal (ULN) threshold for cardiac biomarker release to define peri-procedural MI in order to reflect a contemporary and prognostically relevant definition of MI.

At 90 days, lower MAE (same 10 components as defined in the PROTECT II Study) and major adverse cardiac and cerebrovascular events (MACCE – a subset of the components used in the MAE definition) rates were observed in the Impella® group compared to IABP when this contemporary definition of peri-procedural myocardial infarction (8x ULN) was used (Tables 6.13a and 6.13b).

Table 6.13a Composite MAE at 30 and 90 Days Using Contemporary Definition for Peri-Procedural MI (8x ULN) (Intent-to-Treat Population and Per-Protocol Population)

MAE at 30 Days	Impella®	IABP	Difference	Relative Reduction or Increase
ITT (N=448)	31%	38%	- 7%	- 18.4%
PP (N=427)	30%	40%	- 10%	- 25.0%

MAE at 90 Days	Impella®	IABP	Difference	Relative Reduction or Increase
ITT (N=448)	37%	47%	- 10%	- 21.3%
PP (N=427)	37%	49%	- 12%	- 24.5%

Table 6.13b Composite MACCE at 30 and 90 Days Using Contemporary Definition for Peri-Procedural MI (8x ULN) (Intent-to-Treat Population and Per-Protocol Population)

MACCE at 30 Days	Impella®	IABP	Difference	Relative Reduction or Increase
ITT (N=448)	15%	19%	- 4%	- 21.1%
PP (N=427)	14%	20%	- 6%	- 30.0%

MACCE at 90 Days	Impella®	IABP	Difference	Relative Reduction or Increase
ITT (N=448)	22%	30%	- 8%	- 26.7%
PP (N=427)	22%	31%	- 9%	- 29.4%

	Time after Initial Procedure (days)					Time after Initial Procedure (days)			
	0	30	60	90		0	30	60	90
MAE PP					MACCE PP				
Impella® Patients At Risk	216	174	151	116	Impella® Patients At Risk	216	202	185	153
IABP Patients At Risk	211	167	129	103	IABP Patients At Risk	211	197	169	135

PP MAE Rates

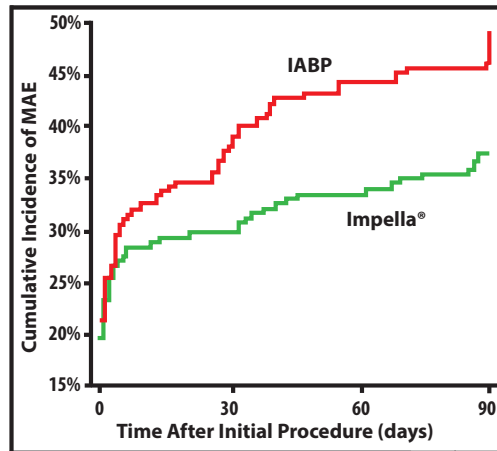

PP MACCE Rates

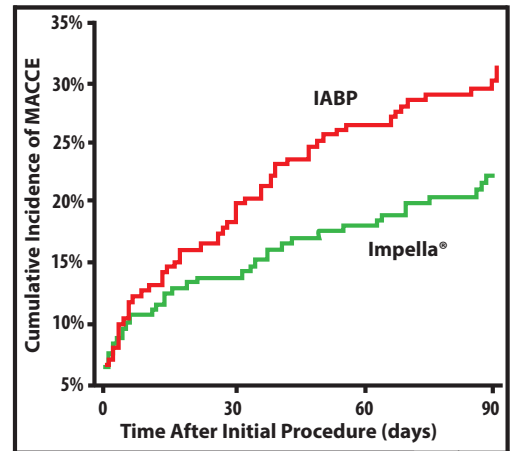
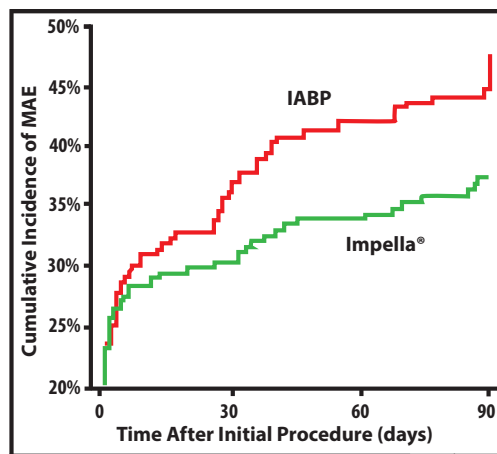

Figure 6.5 Additional Analysis of the Composite MAE and MACCE Rates in the Per-Protocol Population Using a Meaningful, Contemporary Definition for Peri-Procedural MI (8x ULN)

	Time after Initial Procedure (days)					Time after Initial Procedure (days)			
	0	30	60	90		0	30	60	90
MAE ITT					MACCE ITT				
Impella® Patients At Risk	225	180	156	129	Impella® Patients At Risk	225	209	191	159
IABP Patients At Risk	223	178	138	111	IABP Patients At Risk	223	208	178	143

ITT MAE Rates



ITT MACCE Rates

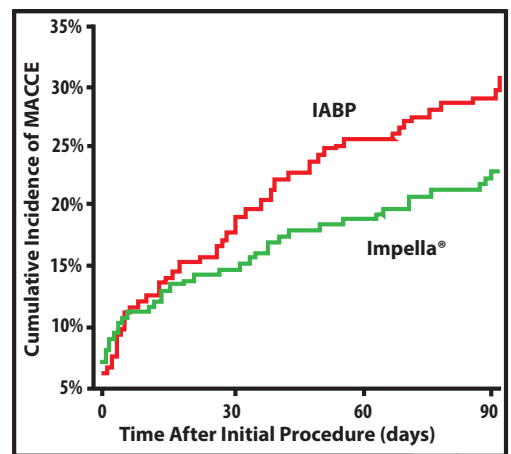

Figure 6.6 Additional Analysis of the Composite MAE and MACCE Rates in the Intent-to-Treat Population Using a Meaningful, Contemporary Definition for Peri-Procedural MI (8x ULN)

USPELLA REGISTRY - IMPELLA 2.5

Abiomed opened a voluntary registry (USpella) for Impella® use in the U.S. for all of its Impella devices, including the Impella 2.5®. Data is collected at all participating sites retrospectively without pre-selection of patients, and included high-risk PCI patients treated with the Impella 2.5 System (albeit from a broader high-risk PCI patient population than defined in the PROTECT II Study). The PROTECT II criteria was superimposed on this group of data and yielded an analysis containing 637 patients. These Impella 2.5 System registry data were used as supplemental informative clinical data for FDA review of the Impella 2.5 System PMA P140003, within context of the indications for use.

Outcomes and Limitations

Considering the retrospective nature of the registry design, there is a risk for some adverse events to not be documented. This is particularly true for adverse events that were defined based on temporal profile of biomarkers (such as cardiac or renal biomarkers) that require, regular, and periodic monitoring of the blood samples which may not be performed as frequently (if at all) during routine care across institutions. Other events such as the frequency of hypotensive events may also not be properly documented if accounted for retrospectively based on patient chart review.

However, mortality outcomes are relevant to report and compare to the PROTECT II trial for the following reasons: 1) USpella outcomes to discharge were obtained for 100% of the patients; and 2) death is very likely to be known and reported if the patient expired within the index hospitalization; and 3) USpella data could provide a real-world estimate of the potential expected mortality for patients that are deemed to require hemodynamic support with the Impella 2.5 while undergoing high-risk PCI. Mortality outcomes in USpella are depicted in Figure 6.7. Benchmark with PROTECT II data is also provided.

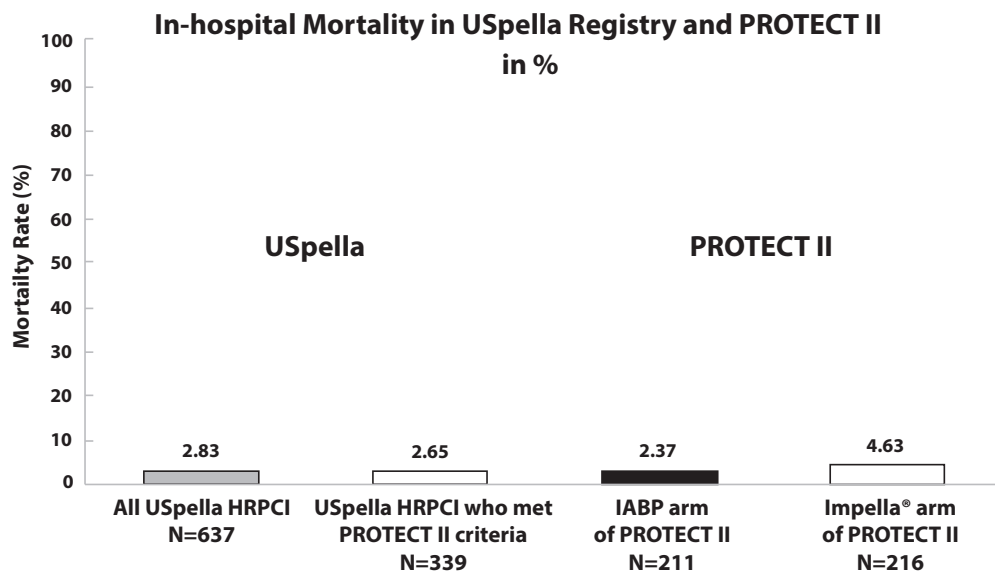

Figure 6.7 In-Hospital Mortality for “All USpella HRPCI Patients,” “All USpella HRPCI Patients who met PROTECT II Criteria” and PROTECT II Patients for Both IABP and Impella 2.5 Arm

Mortality was similar between the USPella subsets and PROTECT II Impella 2.5® arm and IABP arm. This supports the observation in the PROTECT II trial (448 patient cohort) that there was no increased risk for mortality associated with the use of Impella® and large bore access sheath compared to IABP.

USPELLA REGISTRY- IMPELLA CP®

Because of their close similarity of design, the primary clinical data set provided above for the Impella 2.5 for the same indication is applicable for the use of the Impella CP in the same high-risk PCI (HRPCI) patient population. However, to further support the safety and effectiveness for use of the Impella CP in HRPCI patients, additional confirmatory clinical evidence from the USPella Registry was also reviewed by the FDA.

The USPella Registry data reviewed included results from an analysis of a cohort of consecutive, unselected patients in whom the Impella CP was used for the HRPCI indications for use. Specifically, a comparison of the two cohorts of patients, those supported with Impella CP (N=72) or Impella 2.5 (N=637) was reviewed. The Impella 2.5 cohort is identical to the cohort provided in the USPella Registry section above. The time interval for the patient selection is provided in Figure 6.8. All reported cases at Impella registry active sites supported with Impella CP for the indication of HRPCI between January 2014 and August 2014 were included. Details of the analyses of datasets for the two cohorts, which were reviewed by the FDA, are provided below.

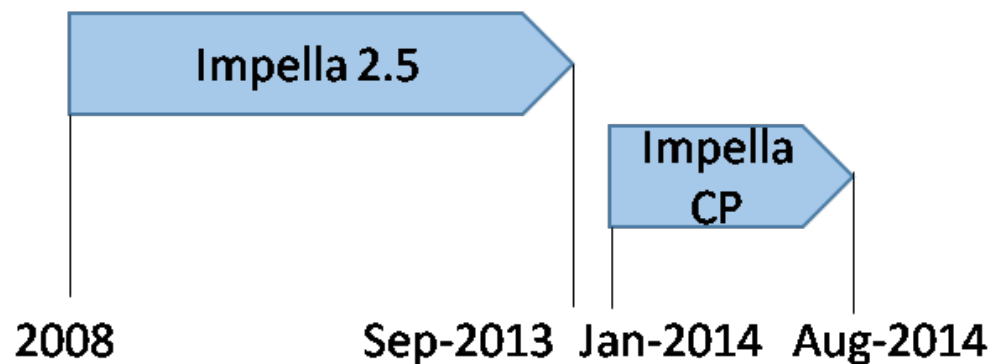

Figure 6.8 Time Intervals for Impella Implants (Patient Selection) by Type of Device

Baseline Characteristics Comparison

Patient demographics and baseline hemodynamic characteristics for the HRPCI patients supported with both devices were analyzed for both groups. Generally, both cohorts had advanced age (70 years), presented with severe coronary artery disease (CAD) and had multiple co-morbidities including: diabetes mellitus (50%), renal insufficiency (30%), congestive heart failure (55%), cardiomyopathy (45%), prior myocardial infarction (50%), prior PCI (47%) or prior CAGB (30%), and high STS mortality scores. The only difference in the demographics between the Impella 2.5 and Impella CP groups was a higher prevalence of congestive heart failure in the Impella CP patients (69.4% vs. 52.8%, $p=0.008$). The hemodynamic characteristics of the patients were also comparable, with baseline left ventricular ejection fraction (LVEF) being slightly lower in the Impella CP group, and the STS mortality and morbidity scores being slightly higher in the Impella 2.5 group compared to the Impella CP group.

Admission, procedural and support characteristics were also analyzed for both groups. The main differences were:

- more patients in the Impella CP group were admitted for acute myocardial infarction (38.9% vs. 28.4%, $p=0.076$)
- fewer patients in the Impella CP® group were recommended for CABG compared to the Impella 2.5 group (21.1% vs. 37.1%, $p=0.008$).
- more patients in the Impella CP group had intervention on the left main (LM) coronary artery and/or left anterior descending (LAD) artery (56.8% vs. 49.97%, $p=0.084$).
- more patients in the Impella CP group were treated with rotational atherectomy (27.8% vs. 16.7%, $p=0.032$).
- the Impella CP provided higher pump flows (3.03 vs. 2.09 L/min, $p=0.001$).

Hemodynamics were also measured. Baseline hemodynamics were similar for both cohorts. As expected, during support, both the Impella 2.5 and the Impella CP significantly increased the diastolic and the mean arterial blood pressures.

CLINICAL OUTCOMES COMPARISON

The patient outcomes, as determined by the mortality and the site reported adverse events (AEs) were also analyzed. The results are provided in Table 6.14. Overall, there were no significant differences in adverse event rates between the patients supported with Impella CP and those supported with Impella 2.5.

Table 6.14 In-Hospital Site-Reported AEs for HRPCI Patients Supported with Impella 2.5 or Impella CP in Impella Registry

Adverse Events	Impella 2.5 (N=637 Patients)	Impella CP (N=72 Patients)	Relative Reduction or Increase
Death	2.83% (18/637)	2.78% (2/72)	1.000
Myocardial Infarction	0.78% (5/637)	0.00% (0/72)	1.000
CVA/Stroke	0.00% (0/637)	0.00% (0/72)	--
TIA	0.00% (0/637)	0.00% (0/72)	--
Revascularization (including Emergent CABG)	0.94% (6/637)	0.00% (0/72)	1.000
Aortic Valve Injury	0.00% (0/637)	0.00% (0/72)	--
Aortic Valve Regurgitation >=2 Grades from Baseline	0.00% (0/637)	0.00% (0/72)	--
Bleeding requiring Surgery	0.47% (3/637)	1.39% (1/72)	0.349
Bleeding requiring Transfusion	7.54% (48/637)	5.56% (4/72)	0.810
Device Malfunction	0.16% (1/637)	1.39% (1/72)	0.193
Hematoma	5.02% (32/637)	6.94% (5/72)	0.412
Vascular Complication requiring Surgery	2.04% (13/637)	2.78% (2/72)	0.658
Vascular Complication without Surgery	2.04% (13/637)	4.17% (3/72)	0.216
Limb Ischemia	0.63% (4/637)	1.39% (1/72)	0.416
Hemolysis	0.00% (0/637)	0.00% (0/72)	--
Hematuria	1.41% (9/637)	1.39% (1/72)	1.000
Acute Renal Dysfunction	5.97% (38/637)	2.78% (2/72)	0.417
Acute Hepatic Failure	0.47% (3/637)	1.39% (1/72)	0.349
Acute Bowel Ischemia	0.31% (2/637)	0.00% (0/72)	1.000
Need for Cardiac, Thoracic, Abdominal Vascular Operation or Femoral Artery Bypass Graft (Not isolated Femoral Artery)	0.16% (1/637)	0.00% (0/72)	1.000
Hypotension During Support	9.73% (62/637)	11.11% (8/72)	0.678
Infection	3.61% (23/637)	2.78% (2/72)	1.000
Cardiopulmonary Resuscitation or Ventricular Arrhythmia	3.14% (20/637)	4.17% (3/72)	0.721
Failure to Achieve Angiographic Success (as Residual Stenosis <30% after stent implant)	0.31% (2/637)	0.00% (0/72)	1.000

Kaplan-Meier estimates for the 30-day survival are provided in Figures 6.9 for each device cohort patients. As shown in the Figure, survival to 30 days was high in this population and without any difference with regards to the Impella device used for support (94.6% in Impella 2.5® vs. 94.1% in Impella CP®).

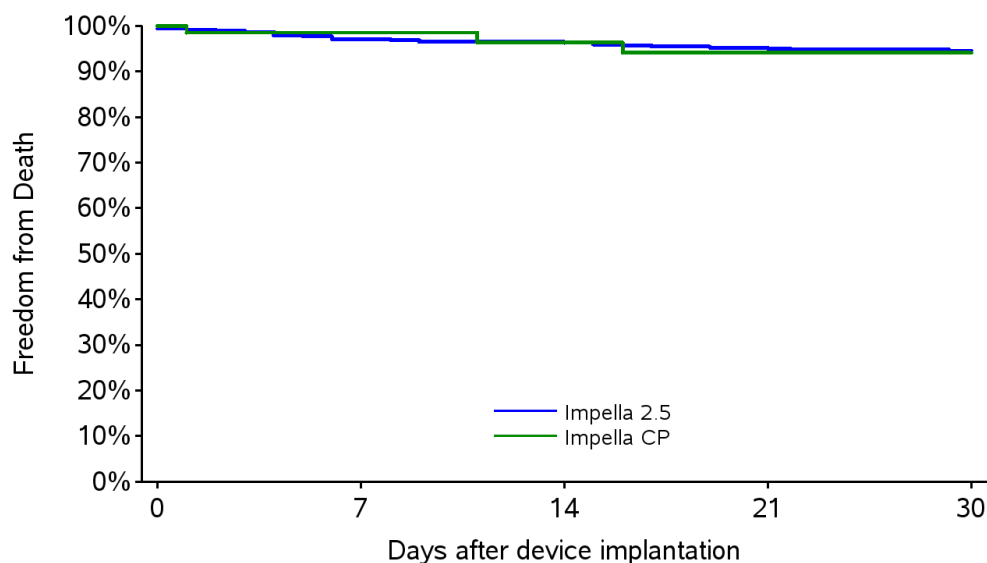

Freedom from Death	Days after device implantation				
	0	7	14	21	30
Impella 2.5 (N=637)					
# Entered	637	633	480	462	443
# Censored	0	141	14	13	13
# Events	4	12	4	6	2
% Survived	99.4%	97.1%	96.3%	95.0%	94.6%
Impella CP (N=72)					
# Entered	72	72	48	43	42
# Censored	0	23	4	0	4
# Events	0	1	1	1	0
% Survived	100.0%	98.5%	96.3%	94.1%	94.1%
Test Between Groups	Test	Chi-Square	Deg Frdm	P-value	
	Log-Rank	0.01	1	0.921	
	Wilcoxon	0.01	1	0.922	

Figure 6.9 Kaplan-Meier Curve for Freedom From Death to 30-days in HRPCL Patients Supported with Impella 2.5 or Impella CP.

All cases of site-reported death from the Impella Registry were adjudicated by an independent clinical event committee (CEC). The results of the adjudications are provided in Table 6.15. None of the Impella CP patient deaths were determined by the CEC to be related to the device. One of the Impella CP patient deaths was determined to be related to the procedure. The patient had acute stent thrombosis causing ventricular fibrillation after the index procedure and required defibrillation, multiple rounds of cardiopulmonary resuscitation (CPR) and a salvage coronary intervention, and expired during the procedure.

Table 6.15 Causes of In-Hospital Deaths for HRPPI Patients Supported with Impella 2.5 or Impella CP® in Impella Registry.

Cause of Death	Impella 2.5 (N=637)	Impella CP (N=72)
Myocardial Infarction	1.26% (8)	2.78% (2)
Decompensated Heart/ Multi-Organ Failure	1.1% (7)	0
Procedural Complication	0.31% (2)	0
Respiratory Failure	0.16% (1)	0
Total	2.83% (18)	2.78% (2)

Overall, the Impella Registry data analyses of use of the Impella CP indicated that:

- patients undergoing HRPPI supported with Impella CP in the routine clinical practice were very sick, and similar to Impella 2.5 patients undergoing HRPPI.
- the use of the Impella CP during HRPPI procedures provided adequate hemodynamic support with a significant increase (from baseline) in the diastolic and mean arterial pressures and similar to Impella 2.5 patients undergoing HRPPI.
- the outcomes of patients undergoing HRPPI procedures supported with Impella CP were similar to the outcomes observed in patients undergoing HRPPI procedures supported with Impella 2.5.
- the overall safety for use of the Impella CP device during HRPPI procedures is favorable with regard to a broad range of adverse events that were monitored, and is similar to the safety for use of the Impella 2.5 in the HRPPI settings.

The Impella Registry data provided further supports the safety and effectiveness for use of the Impella CP in the HRPPI patient population.

LEFT VENTRICULAR EJECTION FRACTION (LVEF) ANALYSIS

Background

The Impella Registry (USPella) data provided in the preceding Section for use of the Impella 2.5 and the Impella CP in HRPPI patients, included patients with severely depressed left ventricular ejection fraction (LVEF≤35%) as well as patients with left ventricular ejection fraction either moderately depressed or normal (35%<LVEF<76%) as reflected in Table 6.16. This section provides additional confirmatory clinical evidence to support the clinical equivalence across patients in both ranges of left ventricular ejection fraction.

Table 6.16 Clinical Evidence to Support the Impella 2.5 and Impella CP Devices for HRPPI

Clinical Data Set	Device	Total Number of Patients in Cohort	Number of
Impella Registry	Impella 2.5	637	149
Impella Registry	Impella CP	72	12

Confirmatory Clinical Data to Further Support Safety and Effectiveness

As described in the Sections above, Impella Registry data has been an important part of the evidence to support the safety and effectiveness in use of the Impella 2.5 and Impella CP during HRPCI. However, to further support the safety and effectiveness for use of the Impella CP in HRPCI patients with left ventricular ejection fraction moderately depressed or normal ($35% < \text{LVEF} < 76%$), additional confirmatory clinical evidence from the USPella Registry was also reviewed by the FDA. The evidence consisted of a comparison of the clinical experience and outcomes of the use of the Impella 2.5 and Impella CP in HRPCI patients with severe ($\text{LVEF} \leq 35%$), versus moderately depressed or normal ($35% < \text{LVEF} < 76%$) left ventricular ejection fraction (LVEF analysis).

The time intervals for patient selection used in the LVEF analysis are provided in Figure 6.10. The dataset used was primarily represented by the cohorts provided previously to support use of the Impella 2.5 and Impella CP during HRPCI (shown in Table 6.16). However, in order to have a homogenous cohort and to maintain comparability for both patient characteristics, treatment strategies and for data collection, the clinical dataset was expanded to include patient data for all cases treated at the registry sites starting at the initial commercial launches for Impella 2.5 and Impella CP through May 2015. This resulted in the addition of 68 patients (beyond those listed in Table 6.16). Details of the analyses of the datasets for the two LVEF cohorts, which were reviewed by the FDA, are provided below.

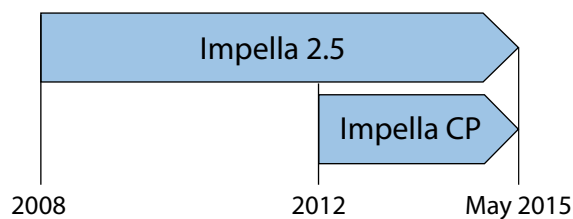

Figure 6.10 Time intervals for Impella Support (Patient Selection) by Type of Device

Baseline Characteristics Comparison

Patient demographics and baseline hemodynamic characteristics for the HRPCI patients supported with both devices were analyzed for both groups, as provided in Table 6.17. Patients with a baseline LVEF>35% were significantly older than patients with LVEF≤35% (72 ±11 years old vs. 69±11 years old). There were also more women in the LVEF>35% group (33.19% vs 21.15%). Also in LVEF>35% group, patients more often had hypertension (94% vs 89%, p=0.048) and numerically higher incidence (although not statistically significant) of hypolipoproteinemia and chronic obstructive pulmonary disease (COPD). Overall, patients in the group with moderately depressed or normal LVEF had many of the high-risk features for PCI, similar with the depressed LVEF group. They had high prevalence of renal failure (25.00%) with 30% of patients with renal failure being on dialysis, diabetes mellitus (45.58%), congestive heart failure (31.98%), prior myocardial infarction (40.45%), prior PCI (42.92%), prior coronary bypass grafting surgery (28.95%), stroke or transient ischemic attacks (6.28%) as well as high Society of Thoracic Surgeon (STS) predicted mortality and morbidity scores; 4.81±6 and 25.45±15 respectively. Although these scores are lower than the respective scores for the LVEF≤35%, they are still indicative of a sicker patient population than all comers PCI population. Surgical consultation was similar between groups, although numerically more patients had surgical consultations in the group with LVEF>35% as compared to the group with LVEF ≤35% (49% vs. 43%, p=0.137).

Table 6.17 Patient Demographics and Baseline Characteristics

Baseline Characteristics	LVEF≤35% (N=464 Patients)	LVEF>35% (N=229 Patients)	P-Value
Age			
Mean±SD(N)	69.02±11.09 (464)	72.14±11.73 (229)	<.001
Gender - Male	78.45% (364/464)	66.81% (153/229)	<.001
Race			
American Indian or Alaska Native	0.66% (3/458)	0.00% (0/228)	0.221
Asian	2.62% (12/458)	1.32% (3/228)	0.271
Black or African American	19.00% (87/458)	14.91% (34/228)	0.186
Caucasian	70.09% (321/458)	75.00% (171/228)	0.178
Other	7.64% (35/458)	8.77% (20/228)	0.608
Height (cm)			
Mean±SD(N)	172.88±10.37 (434)	169.36±10.19 (216)	<.001
Weight (kg)			
Mean±SD(N)	87.04±21.50 (434)	86.45±25.35 (216)	0.769
BSA (m²)			
Mean±SD(N)	2.00±0.25 (433)	1.96±0.28 (216)	0.088
BMI			
Mean±SD(N)	29.08±6.89 (433)	30.00±7.66 (216)	0.126
Medical History			
Smoker	39.05% (173/443)	32.59% (73/224)	0.102
Hyperlipoproteinaemia	76.09% (350/460)	80.62% (183/227)	0.181
Hypertension	89.22% (414/464)	93.86% (214/228)	0.048
Diabetes Mellitus	50.98% (233/457)	45.58% (103/226)	0.183
CAD	86.36% (342/396)	84.85% (168/198)	0.617
Angina	40.36% (159/394)	44.10% (86/195)	0.385
Stroke/TIA	7.89% (30/380)	6.28% (12/191)	0.486
Cerebrovascular Disease	19.10% (85/445)	22.27% (49/220)	0.337
Renal Insufficiency	33.63% (153/455)	25.00% (56/224)	0.022
Dialysis	22.54% (32/142)	30.19% (16/53)	0.270
Liver Insufficiency	2.28% (10/439)	2.74% (6/219)	0.717
COPD	25.28% (112/443)	28.96% (64/221)	0.312
Arrhythmia	36.50% (165/452)	27.85% (61/219)	0.026
PVD	30.82% (139/451)	26.24% (58/221)	0.221
CHF	64.63% (254/393)	31.98% (63/197)	<.001

Table 6.17 Patient Demographics and Baseline Characteristics (continued)

Baseline Characteristics	LVEF≤35% (N=464 Patients)	LVEF>35% (N=229 Patients)	P-Value
NYHA Class			
I	4.17% (8/192)	16.36% (9/55)	0.002
II	22.92% (44/192)	14.55% (8/55)	0.179
III	46.35% (89/192)	38.18% (21/55)	0.282
IV	26.56% (51/192)	30.91% (17/55)	0.525
III/IV	72.92% (140/192)	69.09% (38/55)	0.577
Valvular Disease	15.21% (59/388)	13.71% (27/197)	0.628
Prior MI	55.75% (252/452)	40.45% (89/220)	<.001
Prior AICD/Pacer Implanted	30.09% (136/452)	9.29% (21/226)	<.001
Prior PCI	50.45% (226/448)	42.92% (97/226)	0.065
Prior CABG	29.26% (134/458)	28.95% (66/228)	0.933
Surgical consultation requested	43.08% (193/448)	49.12% (111/226)	0.137
If CABG was declined, reason for refusal			
Subject not a candidate	88.36% (258/292)	81.18% (138/170)	0.033
Subject refused	11.64% (34/292)	18.82% (32/170)	0.033
LVEF (%)			
Mean±SD(N)	21.64±7.95 (464)	52.08±9.30 (229)	<.001
STS Mortality Score			
Mean±SD(N)	6.14±6.64 (425)	4.81±5.77 (212)	0.010
STS Morbidity Score			
Mean±SD(N)	32.22±16.28 (424)	25.45±15.38 (212)	<.001

Patient Admission, Procedural and Support Comparison

Patient admission, procedural and support characteristics by LVEF group are presented in Table 6.18. There were more diseased vessels and more lesions in the group with LVEF>35%, and these patients underwent more extensive revascularization with more vessels and more lesions were treated as compared with the low LVEF group (2.00±0.58 vs 1.77±0.59 and 2.7±1.3 vs. 2.4±1.2, respectively). Patients in the LVEF>35% group had intervention more often on the left main (LM) coronary artery (23.4% vs. 13.04%). Rotational atherectomy was used more often in LVEF>35% patients (20.9% vs.16.2%) compared to LVEF<35% patients and more vigorously (total and average number of passes). In addition, patients in the LVEF>35% group had more simultaneous intervention on distal LM (dLM) and proximal left anterior descending (pLAD) coronary artery (20.18% vs 8.68%) or on distal LM and proximal left circumflex (pLCX) coronary artery (20.18% vs. 7.59%). These differences are suggestive of more complex percutaneous coronary interventions in the LVEF>35% group as compared with lower LVEF group. Duration of device support, duration of ICU stay and total length of stay were shorter in the LVEF>35% group.

Table 6.18 Patient Admission, Procedural and Support Characteristics

Characteristics	LVEF≤35% (N=464 Patients)	LVEF>35% (N=229 Patients)	P-Value
Patient transfer (another hospital)	27.86% (117/420)	26.47% (54/204)	0.716
PCI status			
Elective	55.39% (257/464)	62.01% (142/229)	0.097
Urgent	44.61% (207/464)	37.99% (87/229)	0.097
Acute Myocardial Infarction at admission	28.45% (132/464)	24.45% (56/229)	0.266
STEMI	10.66% (13/122)	9.62% (5/52)	0.837
NSTEMI	89.34% (109/122)	90.38% (47/52)	0.837
Number of diseased vessels (at least one lesion with > 50% stenosis)			
Mean±SD(N)	2.00±0.67 (457)	2.12±0.58 (225)	0.010
Number of Vessels Treated (at least one lesion treated per vessel)			
Mean±SD(N)	1.77±0.59 (457)	2.00±0.53 (225)	<.001
Patients with 1 vessel treated	31.07% (142/457)	13.78% (31/225)	<.001
Patients with 2 vessels treated	60.39% (276/457)	72.44% (163/225)	0.002
Patients with 3 vessels treated	8.53% (39/457)	13.78% (31/225)	0.034
SVG intervention	8.68% (40/461)	7.46% (17/228)	0.584
Number of diseased lesions (>50% stenosis)			
Mean±SD(N)	2.90±1.52 (457)	3.05±1.52 (225)	0.228
Number of lesions treated			
Mean±SD(N)	2.44±1.20 (457)	2.66±1.27 (225)	0.026
Number of stents placed			
Mean±SD(N)	2.20±1.08 (448)	2.34±1.17 (221)	0.112
Duration of Index PCI Procedure (hours)			
Mean±SD(N)	0.98±0.77 (386)	1.01±0.68 (192)	0.579
Duration of Device Support (hours)			
Mean±SD(N)	2.56±7.78 (453)	1.58±2.93 (224)	0.018
ICU stay (days)			
Mean±SD(N)	5.27±5.24 (306)	3.90±4.08 (156)	0.002
Duration of Index Hospitalization (days)			
Mean±SD(N)	8.31±8.22 (464)	6.90±7.66 (229)	0.030
Pump Flow (L/min)			
Mean±SD(N)	2.27±1.06 (317)	2.14±0.43 (152)	0.075

Table 6.18 Patient Admission, Procedural and Support characteristics (continued)

Characteristics	LVEF≤35% (N=464 Patients)	LVEF>35% (N=229 Patients)	P-Value
LAD	34.44% (478/1388)	33.29% (245/736)	0.595
Left Main	13.04% (181/1388)	23.37% (172/736)	<.001
LCx	28.82% (400/1388)	28.26% (208/736)	0.787
RCA	19.09% (265/1388)	11.41% (84/736)	<.001
Graft	4.61% (64/1388)	3.67% (27/736)	0.307
LIMA	0.58% (8/1388)	0.54% (4/736)	0.923
SVG	4.03% (56/1388)	3.13% (23/736)	0.292
Lesion Location			
Proximal	44.93% (496/1104)	43.94% (279/635)	0.689
Mid	31.07% (343/1104)	23.94% (152/635)	0.002
Distal	18.48% (204/1104)	21.42% (136/635)	0.137
Ostial	5.53% (61/1104)	10.71% (68/635)	<.001
dLM and pLAD	8.68% (40/461)	20.18% (46/228)	<.001
dLM abd pLCX	7.59% (35/461)	20.18% (46/228)	<.001
TIMI Flow Pre-PCI			
0	5.86% (34/580)	3.37% (11/326)	0.098
1	2.24% (13/580)	3.37% (11/326)	0.308
2	16.72% (97/580)	14.11% (46/326)	0.300
3	75.17% (436/580)	79.14% (258/326)	0.176
0 or 1	8.10% (47/580)	6.75% (22/326)	0.461
TIMI Flow Post-PCI			
0	1.56% (12/769)	0.47% (2/425)	0.094
1	0.13% (1/769)	1.65% (7/425)	0.002
2	0.52% (4/769)	0.94% (4/425)	0.393
3	97.79% (752/769)	96.94% (412/425)	0.370
0 or 1	1.69% (13/769)	2.12% (9/425)	0.599

Clinical Outcomes Comparison

The patient outcomes, as determined by the mortality and the site reported adverse events (AEs) were also analyzed. The results are provided in Table 6.19. Overall, there were no significant differences in AE rates between the two patients groups. There were no neurological AEs (stroke or transient ischemic attack) reported in either group. Further, no aortic valve injuries/ dysfunctions or hemolysis AEs were observed in either group. The events rates for bleeding and vascular complications were comparable in both groups. There were more hematoma AEs reported in the group of patients with LVEF>35%, most likely due to more women present in this group.

Table 6.19 In-Hospital Site-reported Adverse Events

Adverse Events	LVEF≤35% (N=464 Patients)	LVEF>35% (N=229 Patients)
Death*	3.02% (14/464)	1.75% (4/229)
Myocardial Infarction*	0.22% (1/464)	1.31% (3/229)
CVA/Stroke*	0.00% (0/464)	0.00% (0/229)
TIA*	0.00% (0/464)	0.00% (0/229)
Valve Injury	0.00% (0/464)	0.00% (0/229)
Acute Renal Dysfunction	6.68% (31/464)	2.62% (6/229)
Revascularization (including Emergent CABG)*	0.22% (1/464)	1.31% (3/229)
Hemolysis	0.00% (0/464)	0.00% (0/229)
Acute Hepatic Failure	0.43% (2/464)	0.44% (1/229)
Bleeding requiring Surgery	0.86% (4/464)	0.44% (1/229)
Bleeding requiring Transfusion	6.03% (28/464)	9.17% (21/229)
Device Malfunction	0.43% (2/464)	0.00% (0/229)
Hematoma	4.09% (19/464)	7.86% (18/229)
Vascular Complication requiring Surgery	1.51% (7/464)	2.18% (5/229)
Vascular Complication without Surgery	4.31% (20/464)	3.49% (8/229)
Aortic Valve Regurgitation ≥2 Grades from Baseline	0.00% (0/464)	0.00% (0/229)
Acute Bowel Ischemia	0.22% (1/464)	0.44% (1/229)
Need for Cardiac, Thoracic or Abdominal Vascular Operation or Femoral Artery Bypass Graft	0.22% (1/464)	0.44% (1/229)
Hypotension During Support	6.47% (30/464)	4.80% (11/229)
Infection	1.94% (9/464)	3.49% (8/229)
CPR or Ventricular Arrhythmia	3.66% (17/464)	1.75% (4/229)
Failure to Achieve Angiographic Success [as Residual Stenosis <30% (after stent)]	0.22% (1/464)	0.87% (2/229)
*included in Major Adverse Cardiac and Cerebrovascular Events (MACCE) composite.		

Kaplan-Meier estimates for 30-day survival are provided in Figures 6.11 for HRPCI cohort patients by LVEF group. Survival to 30 days remains high in both populations, with no significant difference with regards to ejection fraction (93.9% in LVEF ≤35% cohort vs. 96.4% in LVEF >35% cohort). The mortality for patients who underwent Impella-supported PCI with LVEF >35 was 1.75% in-hospital and 3.6% at 30-day, lower than their STS predicted mortality.

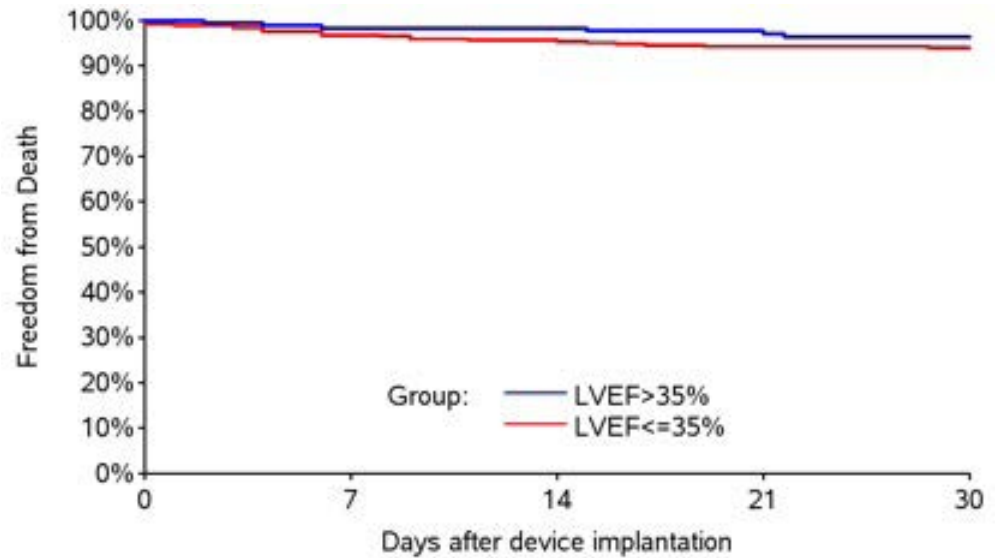

Freedom from Death	Days after device implantation				
	0	7	14	21	30
LVEF ≤ 35% (N=464 Patients)					
# Entered	464	461	349	335	320
# Censored	0	102	9	11	12
# At Risk	464	410	345	330	314
# Events	3	10	5	4	1
# Events per Month	-	55.7	38.6	31.4	23.0
% Survived	99.4%	96.8%	95.4%	94.2%	93.9%
LVEF > 35% (N=229 Patients)					
# Entered	229	229	163	156	150
# Censored	0	63	7	4	3
# At Risk	229	198	160	154	149
# Events	0	3	0	2	1
# Events per Month	-	12.9	6.4	7.1	6.0
% Survived	100.0%	98.3%	98.3%	97.0%	96.4%

Figure 6.11 Kaplan-Meier Curve for Freedom from Death to 30-days in HRPCI Patients.

Kaplan-Meier curves for freedom from Major Adverse Cardiac and Cerebrovascular Events (MACCE) to 30 days in high-risk PCI patients from each ejection fraction group are also displayed in Figure 6.12. The freedom from MACCE rates were high in both populations, with no significant difference with regards to ejection fraction (91.2% in LVEF ≤ 35% cohort vs. 92.6% in LVEF > 35% cohort).

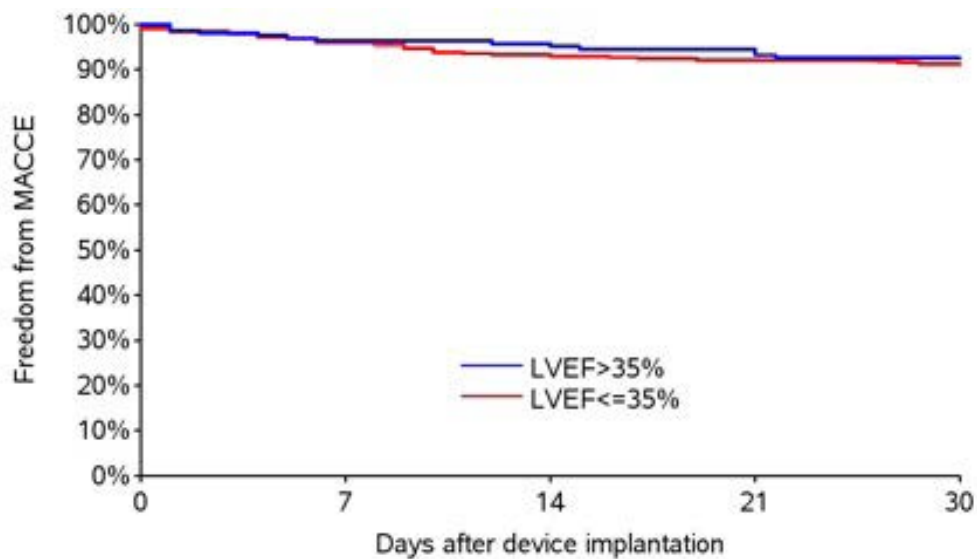

Freedom from Death	Days after device implantation				
	0	7	14	21	30
LVEF<=35% (N=464 Patients)					
# Entered	464	460	347	328	314
# Censored	0	101	8	11	12
# At Risk	464	410	343	323	308
# Events	4	12	11	3	3
# Events per Month	-	68.6	57.9	42.9	33.0
% Free from MACCE	99.1%	96.1%	93.0%	92.1%	91.2%
LVEF>35% (N=229 Patients)					
# Entered	229	229	160	151	144
# Censored	0	62	7	4	3
# At Risk	229	198	157	149	143
# Events	0	7	2	3	1
# Events per Month	-	30.0	19.3	17.1	13.0
% Free from MACCE	100.0%	96.4%	95.1%	93.2%	92.6%

Figure 6.12 Kaplan-Meier Curve for Freedom from MACCE to 30-days in HRPCL

Overall, the Impella Registry data analyses indicated that:

- Patients undergoing high-risk PCI supported with both Impella devices in routine clinical practice, irrespective of their LVEF at the time of the intervention, are very sick, with high-risk features including complex and extensive coronary artery disease and multiple co-morbidities, which would likely exclude them as surgical candidates. In the data set analyzed, >80% of the patients in both groups were turned down for surgery.
- The use of Impella devices during high-risk PCI in the group with LVEF>35% allowed the operators to treat more diseased vessels and lesions, and allowed them to potentially achieve more complete revascularizations (via more extensive rotational atherectomy), when compared to the group with LVEF≤35%. In addition, larger territories of myocardium at risk (including more left main (LM) coronary artery revascularizations) were treated in the group with LVEF>35.
- The safety profile of the Impella devices was acceptable, as demonstrated by the low rates of AEs for the patients undergoing high-risk PCI, for both LVEF ranges studied.
- The effectiveness of the Impella devices, as measured by the 30-day survival outcomes and freedom from MACCE for patients undergoing high-risk PCI, was equivalent for both LVEF ranges studied. In addition, the mortality rate in the LVEF>35% group was lower than the predicted rate (by the STS score).
- The use of the Impella devices was similarly safe and effective in high-risk PCI settings for both LVEF ranges studied.

In conclusion, patients with moderately depressed or normal ejection fraction (35%<LVEF<76%), who were treated with the Impella devices have severe co-morbidities and complex angiographic features, requiring PCI with hemodynamic support. The use of hemodynamic support with Impella devices in these patients was safe and effective.

CONCLUSION

In conclusion, given the totality of the information available for the Impella 2.5 and Impella CP Systems, the data suggests that an observed beneficial therapeutic effect at 90 days likely exists in patients undergoing high-risk interventions (i.e., patients have few, if any other treatment options due to the severity of the underlying coronary artery disease and co-morbidities). This beneficial effect is possibly attributable to the ability to perform more aggressive percutaneous revascularization procedures while being supported by the Impella 2.5 and Impella CP Systems without significantly increasing safety risks, thereby decreasing the late need for symptom-driven coronary artery re-intervention. In addition, supplementary evidence from the USPella Registry demonstrated similar clinical outcomes in real-world use for both the Impella 2.5 and Impella CP Systems.

CLINICAL EXPERIENCE OVERVIEW FOR CARDIOGENIC SHOCK AFTER ACUTE MYOCARDIAL INFARCTION OR OPEN HEART SURGERY

The indication for use to treat ongoing cardiogenic shock following acute myocardial infarction or open heart surgery as a result of isolated left ventricular failure with the Impella 2.5, the Impella CP, the Impella 5.0 and the Impella LD Systems was supported by US and European human clinical data. This information included prospective clinical trials, and data from a retrospective registry, USpella, along with literature reviews. Details of the clinical information reviewed by the FDA for approval of the Cardiogenic shock indication is provided below.

CARDIAC SHOCK AFTER ACUTE MYOCARDIAL INFARCTION - SUMMARY OF PRIMARY CLINICAL STUDIES

PROSPECTIVE RANDOMIZED TRIAL: ISAR-SHOCK (FOR IMPELLA 2.5)

To support for safety and effectiveness, data from a small prospective randomized clinical trial (RCT) was used. The ISAR-SHOCK trial was designed as a prospective, two-center, randomized, open-label study designed to test whether the Impella 2.5 provides superior hemodynamic improvement as compared to the standard procedure utilizing IABP for AMICS patients.

The trial was designed to assess the hemodynamic robustness of the Impella 2.5 against IABP (primary endpoint), as measured by the improvement of cardiac support after device support initiation. Safety data (survival and adverse events) were also studied (secondary endpoints). Details of the study design are below.

CLINICAL INCLUSION AND EXCLUSION CRITERIA

Eligible patients were those who presented with cardiogenic shock within 48 hours of an acute myocardial infarction or suspicion of an acute coronary syndrome. The inclusion and exclusion criteria are below.

Inclusion Criteria

1. Systolic Blood Pressure (SBP) < 90 mmHg during angina pectoris and heart rate > 90/min OR use of catecholamines to maintain SBP > 90 mmHg during angina pectoris;
AND
2. Signs of end-organ hypoperfusion OR Signs of left ventricular failure (Killip class 3 or 4)
3. Left Ventricular Ejection Fraction (LVEF) < 30% and Left Ventricular End-Diastolic Pressure (LVEDP) > 20 mmHg OR
4. Cardiac Index (CI) < 2.2 l/min/m² and Pulmonary Capillary Wedge Pressure (PCWP) > 15 mmHg

Exclusion Criteria (Clinical Only)

1. Age less than 18 years old
2. Resuscitation for more than 30 minutes
3. Obstructive, hypertrophic cardiomyopathy
4. Marginal thrombus in the left ventricle
5. Subjects with implanted IABP at the point in time of randomization
6. Mechanical mitral and/or aortic valve, and/or severe valve stenosis
7. Mechanical cause of cardiogenic shock
8. Right ventricular failure
9. Sepsis
10. Brain damage or suspicion of brain damage
11. Surgically uncontrollable bleeding
12. Massive pulmonary embolism
13. Known coagulopathy or allergy to heparin
14. Aortic insufficiency
15. Participation in another clinical study
16. Pregnancy

Patients were followed up to 6 months. Procedural, hemodynamic, blood data and concomitant medications including catecholamines requirement were collected at baseline and at different times as prescribed by the protocol. Adverse events were recorded throughout the duration of the study.

CLINICAL ENDPOINTS

Primary Endpoint

- Hemodynamic improvement within the first 60 minutes after implantation, as measured by an improvement in cardiac index (CI) immediately following implantation of the study support device.

Secondary Endpoints

- Hemodynamic change during the course of treatment, which is defined as the change in measured values from the baseline (pre-implantation) after 24 and 48 hours using a generally recognized catecholamine dosage.
- Change in the catecholamine dosage for adrenalin or dobutamine from baseline compared to 6, 24, 48 and 96 hours after implantation.
- Survival for 30 days.
- Rates of all adverse events up to 30 days post-implantation.
- Lactate release (defined as a change in the lactate value from baseline compared to 6, 24, 48 and 96 hours after implantation).

ACCOUNTABILITY OF PMA COHORT

Twenty-seven (27) subjects were enrolled in ISAR-SHOCK at 2 centers in Germany between September 15, 2004 and February 17, 2007. Fourteen (14) patients were randomized to the Impella arm and 13 patients to the IABP arm. One (1) patient in the Impella arm (A-03-a) withdrew following consent, but prior to initiation on support. No data was captured for this patient. In addition, one (1) patient in the Impella arm (B-07-a) expired after randomization but prior to device placement.

STUDY POPULATION DEMOGRAPHICS AND BASELINE PARAMETERS

Study population demographics, characteristics and hemodynamics are provided below.

Table 6.20 Baseline Demographics and Characteristics

Parameter	All Subjects	IABP	Impella 2.5	p-value
Number of subjects	26	13	13	
Age in years (mean \pm SD)	65 \pm 13	67 \pm 15	63 \pm 10	0.390
Male %, (number)	73% (19)	85% (11)	62% (8)	0.378
LVEF % (mean \pm SD)	27 \pm 11	28 \pm 12	26 \pm 11	0.619
Number of catecholamines at baseline (mean \pm SD)	1.2 \pm 0.7	1.0 \pm 0.4	1.3 \pm 0.9	0.253
Diabetes %, (number)	27% (7)	8% (1)	46% (6)	0.030
Smoking %, (number)	42% (11)	46% (6)	38% (5)	1.000
Hypercholesterolemia %, (number)	38% (10)	38% (5)	38% (5)	1.000
Arterial Hypertension %, (number)	38% (10)	54% (7)	23% (3)	0.370
Anterior myocardial infarction (number) %	50% (13)	54% (7)	46% (6)	1.000
Time from AMI to support device implant in hours (mean \pm SD)	9.9 \pm 6.4	9.4 \pm 6.6	10.4 \pm 6.5	0.696

Table 6.21 Baseline Hemodynamics

Parameter	All (mean ± SD) (n=25)	IABP (mean ± SD) (n=13)	Impella 2.5 (mean ± SD) (n=12)	p-value
Cardiac Index [l/min/m ²]	1.8 ± 0.6	1.8 ± 0.8	1.7 ± 0.5	0.820
Heart rate [bpm]	96.8 ± 24.7	97.9 ± 24.7	95.5 ± 25.8	0.820
Systolic art. pressure [mmHg]	104.0 ± 21.4	98.6 ± 21.5	109.8 ± 20.6	0.196
Diastolic art. pressure [mmHg]	60.8 ± 14.3	56.5 ± 12.4	65.5 ± 15.2	0.117
Mean arterial pressure [mmHg]	74.9 ± 15.9	71.0 ± 15.6	79.2 ± 15.8	0.206
Systemic vasc. resistance [dyn sec-5]	1605 ± 620	1569 ± 775	1647 ± 399	0.766
Pulmonary capillary wedge pressure [mmHg]	22.1 ± 7.2	21.5 ± 6.7	22.8 ± 8.0	0.685
Central venous pressure [mmHg]	12.4 ± 6.3	12.3 ± 5.6	12.6 ± 7.3	0.916
Lactate [mmol/l]	6.5 ± 4.3	6.6 ± 4.0	6.5 ± 4.7	0.947

SAFETY AND EFFECTIVENESS RESULTS

The safety endpoint, 30-day survival, which was the secondary endpoint in the trial, is provided in Figure 6.13. There was an initial trend for better survival for Impella 2.5 while on device support but late death events occurred with no difference at 30 days. The study was not powered for survival differences to be established between devices considering the limited sample size, therefore, no definitive statement with respect to survival benefit can be made.

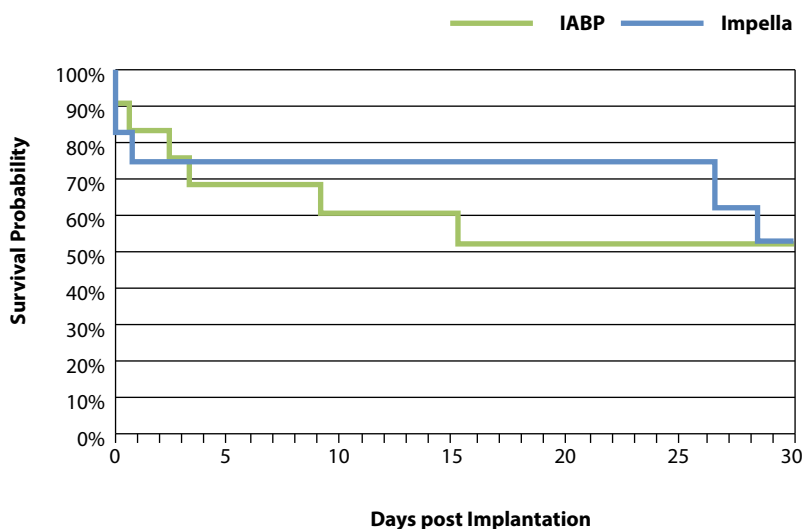

Figure 6.13 Kaplan-Meier Survival Curves Survival (to 30-days) for the ISAR-SHOCK Trial

In addition, Adverse Events (AEs) were monitored for the trial for 30-days post-implant as a secondary endpoint. There were no serious AEs (SAEs) reported. There were four (4) non-serious AEs reported, as shown in Table 6.22.

Table 6.22 Adverse Events Monitoring

Cohort	Adverse Event(s)	Outcome
Impella	Bleeding at insertion site	Manual compression needed (for 20 minutes)
	Hemolysis (two consecutive blood samples)	Resolved in 1 day
	Hematoma at insertion site	Resolved in 1 week
IABP	Ventricular tachycardia	Resolved in 1 day

A third safety endpoint, the lactate levels following support, was monitored. This data is given in Figure 6.14. The results were similar for both study cohorts.

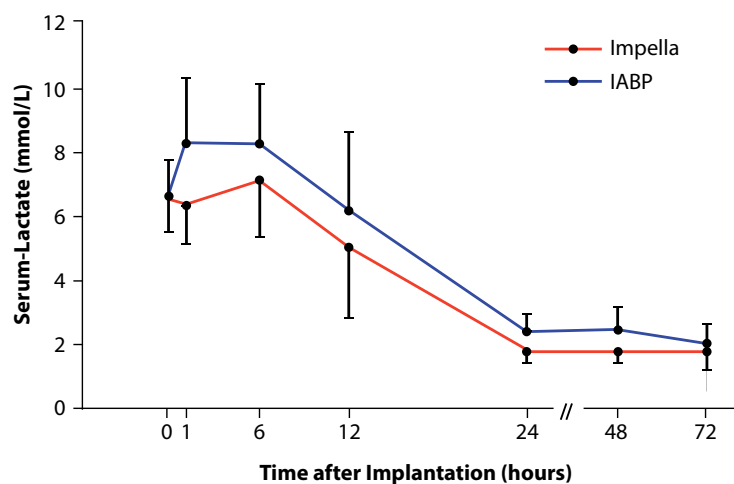

Figure 6.14 Lactate Levels Seen Post-Implant During the Trial

The effectiveness endpoint, which was the primary endpoint of the study, was the change of cardiac index from baseline after device support. The ISAR-SHOCK study showed a significant improvement of cardiac index in the Impella 2.5 arm compared to the IABP arm post-device insertion, as shown in Figure 6.15. In addition, after 24 hours of support, fewer patients supported with the Impella 2.5 required inotropes compared to patients supported with an IABP, as shown in Figure 6.16.

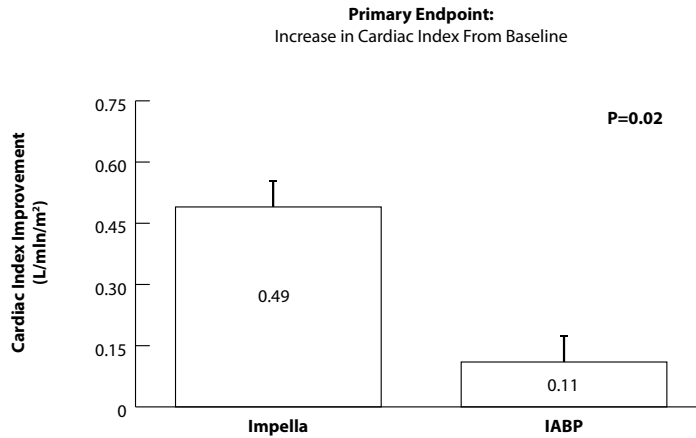

Figure 6.15 Increase in Cardiac Index from Baseline, Impella vs. IABP 30 Minutes Post-Support, in Patients Treated for Cardiogenic Shock After an AMI (ISAR-SHOCK)

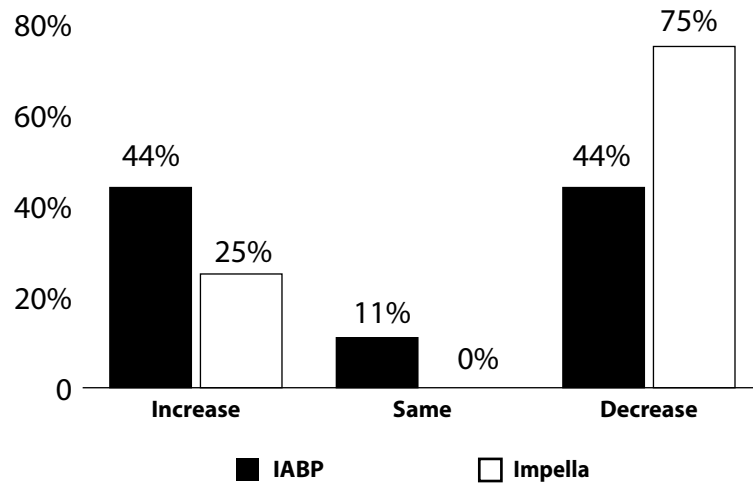

Figure 6.16 Change in Inotropic Dosage at 24-Hours, Impella vs. IABP, in Patients Treated for Cardiogenic Shock After an AMI (ISAR-SHOCK)

DEVICE FAILURES AND REPLACEMENTS

There were no device failures or replacements reported during the study.

FINANCIAL DISCLOSURE

The Financial Disclosure by Clinical Investigators regulation (21 CFR 54) requires applicants who submit a marketing application to include certain information concerning the compensation to, and financial interests and arrangement of, any clinical investigator conducting clinical studies covered by the regulation. This clinical study included 2 investigators. Neither of the clinical investigators had disclosable financial interests/arrangements as defined in sections 54.2(a), (b), (c), and (f). The information provided does not raise any questions about the reliability of the data.

SUMMARY OF SUPPLEMENTAL CLINICAL INFORMATION

Supplemental data from the Impella Registry was provided to demonstrate real-world use for the patient population. Several analyses of the Impella Registry data were provided to support the safety and effectiveness of use of the Impella devices. An analysis of the Impella Registry was also provided to differentiate the outcomes for different treatment groups. In addition, the sponsor also provided a benchmark comparison of the Impella Registry data to a comparable registry dataset for its surgical VAD, the AB5000 Ventricle (PMA approved for a similar indication). Clinical data from a separate clinical trial (RECOVER I) was also provided to demonstrate hemodynamic effectiveness of the Impella 5.0/Impella LD device during use. As further evidence, a detailed literature review was also provided to support the overall safety and efficacy of the Impella devices.

REAL-WORLD IMPELLA REGISTRY RESULTS (FOR ALL IMPELLA DEVICES)

The Impella Registry is an ongoing, multi-center, retrospective, observational registry for collection of de-identified data for patients treated with the Impella 2.5, Impella CP, Impella 5.0 and Impella LD Support Systems. The registry, which was started by Abiomed in 2009, is open for participation by qualifying sites in the U.S. and Canada. Since the registry was started, to date a total of 59 sites have participated. As of June 30, 2015, there were 40 open sites. The sites include high- and low-volume centers, academic (teaching) and non-academic hospitals, public and private institutions as well as for-profit and not-for-profit centers, almost entirely from the United States, thus providing a good representation of U.S. clinical practice. In addition, Abiomed used the Impella Registry as supporting evidence in its original PMA (P140003) application for the Impella 2.5 System. After reviewing the data, the FDA stated (In the PMA's SSED):

"Use of the device in a comparable patient group, as collected retrospectively via Abiomed's USpella (Impella Registry) database, showed results similar to those obtained in the PROTECT II clinical trial for overall patient outcomes and hemodynamic support during use."

The data collection from the Impella Registry includes IRB approval, complete data monitoring, adverse events (AEs) monitoring and CEC adjudication of major AEs. All data is entered electronically by the sites. For this PMA, the time during which the Impella Registry data was used is shown in Figure 6.17. Eligible patients were those who were reported in the Impella Registry, presented with AMICS and underwent mechanical revascularization with either percutaneous coronary intervention (PCI) or coronary artery bypass grafting (CABG), and required mechanical circulatory support with Impella devices.

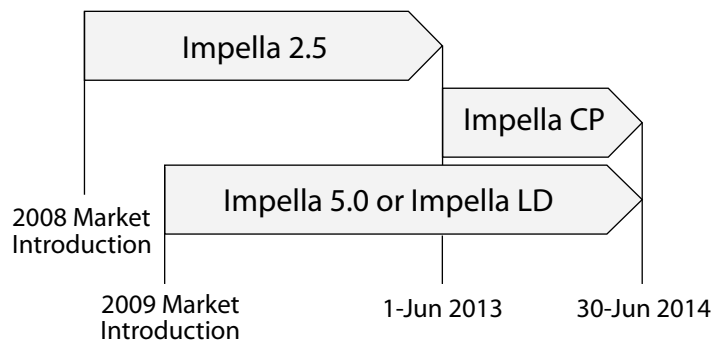

Figure 6.17 Time Intervals for Impella Implants Data Collection by Type of Device

Cases were initially identified using Abiomed’s commercial patient tracking system, and then further reviewed to verify that each case was applicable for this supplement (i.e. was an AMICS patient). Using this method, three hundred twenty-four (324) Impella cases were enrolled into the U.S. Impella Registry for this analysis. These included 189 Impella 2.5 cases, 111 Impella CP cases and 24 (combined) Impella 5.0 and Impella LD cases.

The data included: patient’s demographics and baseline characteristics (risk factors, medical history and history of previous cardiac interventions), clinical presentation for the index hospitalization, index cardiac procedure information, Impella device information, hemodynamic parameters pre-, during and post-Impella support, cardiovascular medication, laboratory results, patient’s outcome information at discharge and 30-day follow-up as well as site-reported adverse events. Both site-reported safety data and CEC-adjudicated data are presented.

The data showed that AMICS patients were on average 65 years old, the majority were male (75%) with significant risk factors and comorbidities including smoking (48%), diabetes (42%), hypertension (71%), renal insufficiency (24%), a Society of Thoracic Surgery (STS) scores for mortality of 21% and morbidity of 60%. The patients presented with high heart rate, poor hemodynamics despite pressors and inotropes, signs of tissue hypoperfusion (lactates) and end-organ dysfunction (creatinine). These characteristics were generally the same for all Impella devices, except for: the gender distribution had more male patients in the Impella 2.5 and Impella CP groups (compared to Impella 5.0/Impella LD) and a higher proportion of patients transferred from outlying facility in patients supported with the Impella 5.0/Impella LD (compared to patients supported with the Impella 2.5 or Impella CP).

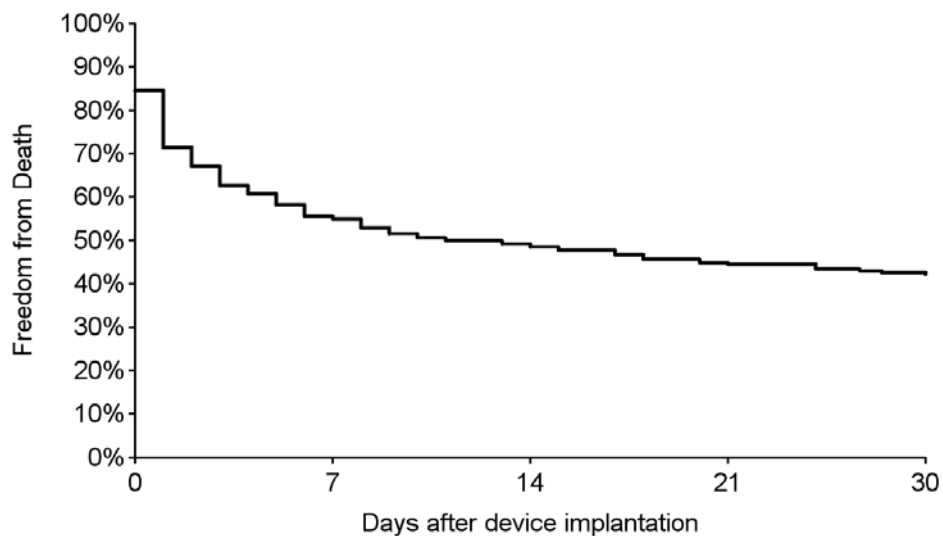

Figure 6.18 Kaplan-Meier Curve Estimates for 30-day Survival – All Patient Cohort

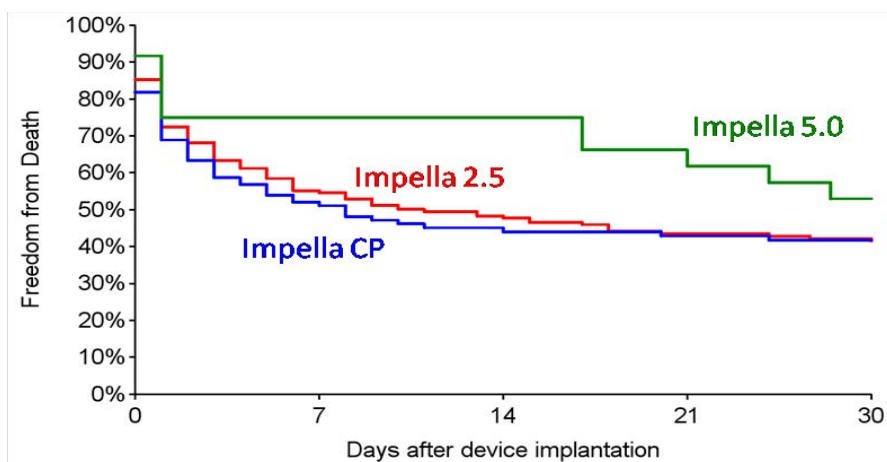

Figure 6.19 Kaplan-Meier curve Estimates, 30-day Survival (by device) - All Patient Cohort

As a further breakdown of the survival outcomes, 29% of the patients expired on Impella device support and 71% were successfully supported to recovery or to next therapy (bridge-to-bridge). In aggregate, 45.7% were discharged (85.8% with recovery, 12.8% transferred to another hospital on Impella support for care management and potential heart transplant or bridge-to-transplant or destination therapy, 1.35% discharged on long-term implantable VAD). By device, 45%, 46% and 50% of the Impella patients survived to discharge for the Impella 2.5, Impella CP and 5.0/Impella LD, respectively. There was no observed difference in outcomes between the different devices, but a trend for better outcomes was seen for patients treated with Impella 5.0/ Impella LD (see Figure 6.19).

ADDITIONAL ANALYSIS OF THE IMPELLA REGISTRY DATA

An additional analysis of different subsets of the Impella Registry patients was provided. The analysis was completed to attempt to evaluate a potential benefit of Impella in a subgroup of the Impella Registry patients, which would be similar to patients selected in prior randomized AMICS RCTs. This was accomplished by dividing the Impella Registry into two groups, an “RCT group” or a group who may have qualified for an AMICS RCT that has been conducted (i.e., SHOCK trial) and a group of “salvage” patients, who would typically be excluded from an AMICS RCT. Specifically, the “salvage patient population” included patients who presented with anoxic brain injury prior to implant, out-of-hospital cardiac arrest and those who were transferred from outlying hospital. These higher-risk patients would usually be excluded from RCTs because of the time delay in providing care or severity of the insult that makes the shock irreversible despite effective hemodynamic support. The RCT subgroup consisted of 111 patients and the “salvage” subgroup was made up of the remaining 209 patients:

The overall 30-day survival results (Kaplan-Meier curve estimates) for the two subgroups described above are shown in Figure 6.20. As expected, the “salvage” group of patients has poorer outcomes than the RCT group, which is more representative of patients chosen for AMICS RCTs.

In addition, the outcomes data for both 30-day survival and survival to discharge are provided in Figures 6.21 and 6.22, respectively, for each Impella device. Interestingly, there appears to be a trend (most noticeable for the RCT group) for an incremental improvement in outcomes with increased flow (from Impella 2.5 to Impella 5.0/Impella LD). This trend reinforces the principle¹ that an increase in the amount of support (CPO) affects outcomes in patients in whom the cardiogenic shock condition is still reversible.

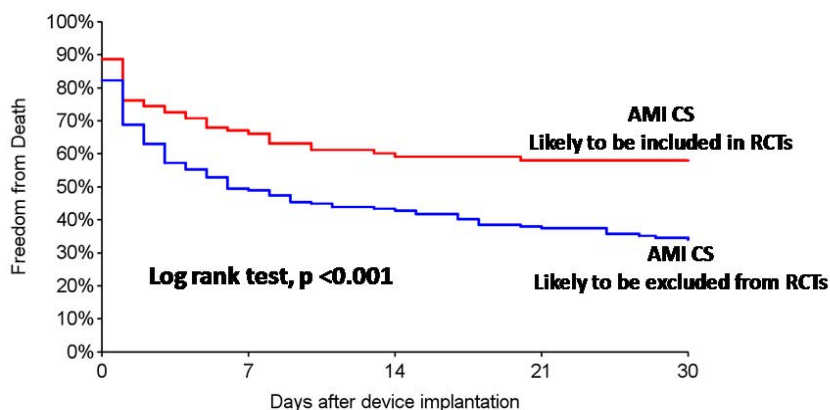

Figure 6.20 Outcomes Between Impella Registry Subgroups: Patients Likely to be Eligible for RCTs vs. Patients Likely to be Excluded from RCTs (“Salvage” Patients)

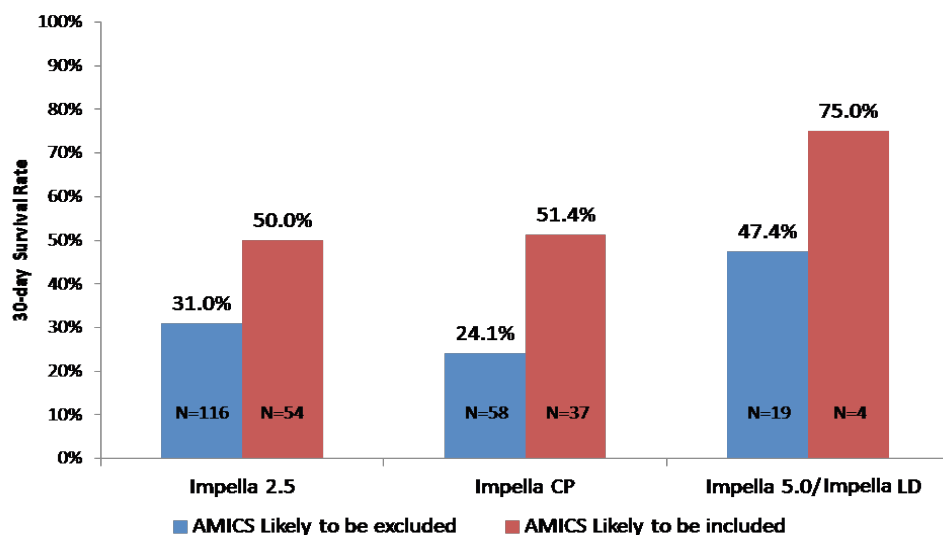

Figure 6.21 30-day Outcomes (By Device) Between Impella Registry Subgroups: Patients Likely to be Eligible for RCTs vs. Patients Likely to be Excluded from RCTs (“Salvage” Patients)

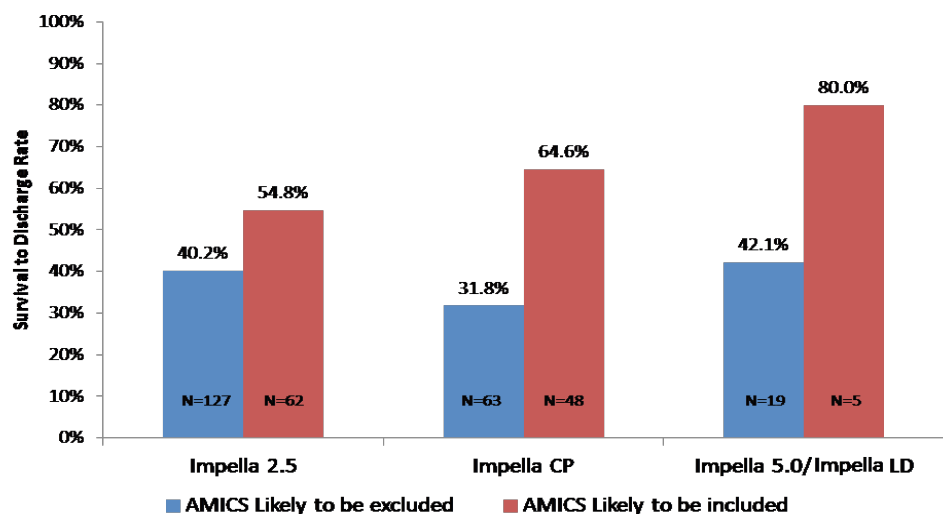

Figure 6.22 Survival to Discharge Outcomes (By Device) Between Impella Registry Subgroups: Patients Likely to be Eligible for RCTs vs. Patients Likely to be Excluded From RCTs (“Salvage” Patients)

BENCHMARKING IMPELLA VS. APPROVED VAD IN AMICS

In order to provide a benchmark for the Impella devices in a comparable clinical setting (AMICS), Abiomed analyzed the results from its real-world registry for the AB5000 Ventricle. The AB5000 Ventricle was PMA approved (P900023/S038) in 2003 as a temporary VAD for use to treat AMICS. The AB5000 Registry was a retrospective registry, which included data collected from U.S. sites between October 3, 2003 and December 11, 2007. The AB5000 Registry included data with demographics, procedural and hemodynamic characteristics, outcomes and adverse events.

The AB5000 Registry includes 2,152 patients. After reviewing the AB5000 Registry and matching the two cohorts (Impella and AB5000 for AMICS), 115 cases from the AB5000 Registry were eligible matches for the benchmark analysis.

The benchmark analysis included the overall survival to 30 days and to discharge in the AMICS patient group. The 30-day Kaplan-Meier estimates are provided in Figure 6.23. The results are provided for each Impella device. In addition, the survival-to-discharge results are provided in Figure 6.24.

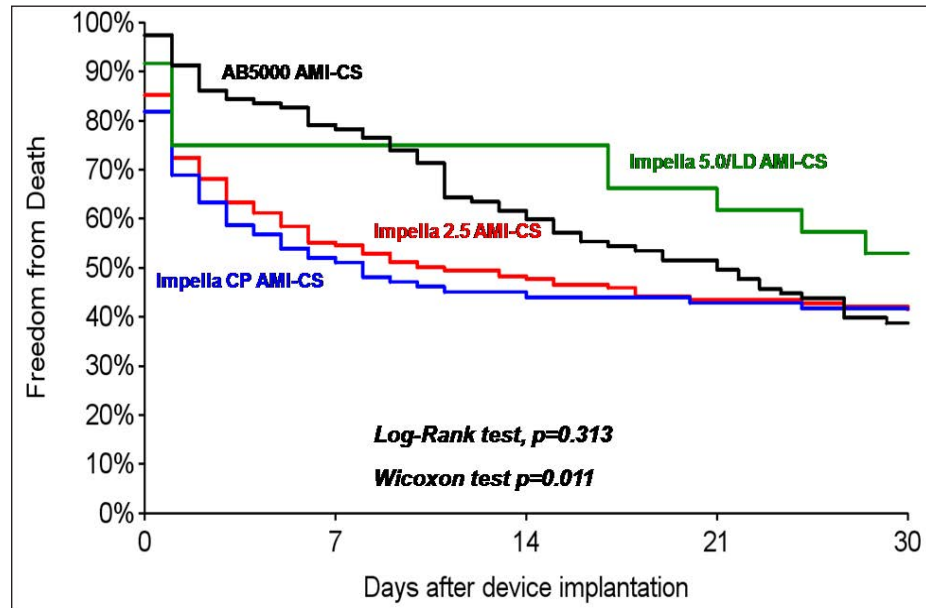

Figure 6.23 Kaplan-Meier Curve Estimates for 30-day Survival

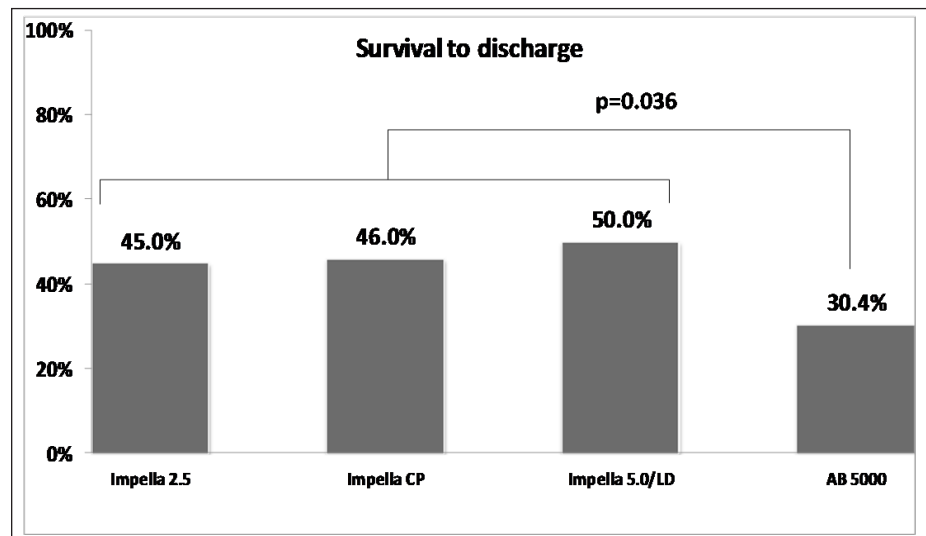

Figure 6.24 Survival to Discharge in AMICS Cohort

The trends in the Kaplan-Meier curve support the assertion that outcomes are improved when more robust hemodynamic support (i.e., flow) is provided to these hemodynamically compromised patients. Indeed, Impella 5.0/Impella LD and AB5000 initially exhibit the highest survival. However, the data shows that the survival to discharge was significantly lower in the AB5000 cohort compared to the Impella cohort (30.43% vs. 45.68%, $p=0.036$), even though the AB5000 is the most potent device. For this comparison, the longer duration of support and the invasiveness of the AB5000 likely increases the risk of device-related morbidities as the support is extended. These issues can result in serious complications culminating in death events. Therefore, a potential benefit of the higher hemodynamic support of a surgical VAD is offset by the high complication rates that impair outcomes.

In addition, to assess overall safety of use of the Impella devices, the rates of site-reported in-hospital adverse events were compared. The results of this comparison are provided in Table 6.23. There are several noteworthy differences between the Impella and AB5000 safety profiles.

- The cerebral vascular accident (CVA) and stroke events were significantly higher in AB5000 cohort compared to the Impella devices, which could be explained by the longer duration of support with the AB5000, and its much larger blood-contacting device surface area and areas of stasis in the device that interact with the patient blood compared to the Impella device.
- The bleeding rates differed among the groups. For Impella 5.0/Impella LD group, only 4 patients underwent percutaneous coronary intervention, with the remainder receiving surgical revascularization (i.e., a CABG procedure). As a result, the bleeding rates were similar between the Impella 5.0/Impella LD and AB5000. These were mainly surgical bleeding. However, the bleeding rates for Impella 2.5 and Impella CP, which were placed percutaneously in AMICS patients undergoing PCI, were much lower compared to the other two groups. There were no device-related bleeding events reported.
- There were also differences in the infection rates, with higher incidence in the Impella 5.0/Impella LD and AB5000 groups. Although infections were reported more frequently for the Impella 5.0/Impella LD, this most likely due to more rigorous contemporary process of reporting adverse events, including all infections (urinary tract infections, streptococcus throat, etc.) in the Impella Registry. None of the infections was determined to be related to the device.

Adverse Events	Impella 2.5 (n=189)	Impella CP (n=111)	Impella 5.0/ Impella LD (n=24)	AB5000/ BVS/AB (n=115)	p-value
Death	55.03% (104/189)	54.05% (60/111)	50.00% (12/24)	69.57% (80/115)	0.036
CVA/Stroke	2.65% (5/189)	3.60% (4/111)	4.17% (1/24)	21.74% (25/115)	<.001
TIA	0.00% (0/189)	0.00% (0/111)	0.00% (0/24)	5.22% (6/115)	0.002
Acute Renal Dysfunction	27.51% (52/189)	31.53% (35/111)	41.67% (10/24)	25.22% (29/115)	0.355
Hemolysis	8.47% (16/189)	10.81% (12/111)	8.33% (2/24)	10.43% (12/115)	0.900
Acute Hepatic Failure	10.58% (20/189)	16.22% (18/111)	12.50% (3/24)	11.30% (13/115)	0.516
Bleeding	19.58% (37/189)	17.12% (19/111)	41.67% (10/24)	37.39% (43/115)	<.001
Infection	17.46% (33/189)	13.51% (15/111)	50.00% (12/24)	26.96% (31/115)	<.001
MSOF	1.59% (3/189)	0.00% (0/111)	4.17% (1/24)	18.26% (21/115)	<.001
Respiratory Dysfunction/ Failure	10.05% (19/189)	14.41% (16/111)	41.67% (10/24)	22.61% (26/115)	<.001
Supraventricular Arrhythmia	5.82% (11/189)	6.31% (7/111)	16.67% (4/24)	7.83% (9/115)	0.253
Other	19.58% (37/189)	18.02% (20/111)	41.67% (10/24)	27.83% (32/115)	0.032
<i>CVA: Cerebrovascular accident; TIA: Transient Ischemic Attack; MSOF: Multisystem Organ Failure</i>					

Overall, the benchmark analysis reveals that AMICS patients in the Impella Registry had better outcomes to discharge than the patients in the AB5000 Registry. This is likely due to the increased risk with mortality and morbidity associated with a prolonged support and invasiveness that comes with the AB5000 technology. The comparison also showed that the rates of complications were lower in the U.S. Impella Registry cohort. This may have been a result of the less invasive approach for insertion and operation, shorter duration of support, ease of use to allow earlier mobilization of patients and a reduced ICU and hospital stay.

HEMODYNAMIC EFFECTIVENESS RESULTS

The Impella Catheters directly unload the left ventricle (LV) and propel blood forward, from the left ventricle into the aorta, in a manner most consistent with normal physiology. Impella provides both an active forward flow^{2,3}, and systemic aortic pressure (AOP) contribution,^{1,2,4} leading to an effective increase in mean arterial pressure (MAP) and overall cardiac power output (CPO).^{1,5} Combined with LV unloading, Impella support reduces end-diastolic volume and pressure (EDV, EDP)^{1,2} and augments peak coronary flow,^{1,2,6,7} leading to a favorable alteration of the balance of myocardial oxygen supply and demand. This cascade of hemodynamic effects has been described in the literature⁸ and validated in computational modeling and a variety of pre-clinical and clinical studies.¹⁻⁷

As initial clinical evidence of the hemodynamic benefits of Impella support, results from a clinical trial with the Impella 5.0 and Impella LD are provided. The study, RECOVER I, was an FDA-approved, prospective, single-arm study that evaluated the safety, hemodynamic benefit and feasibility for the Impella 5.0 and the Impella LD in post-cardiotomy settings. As part of the study, hemodynamic data was collected at baseline and over time to evaluate the robustness of the hemodynamic support with the Impella 5.0 and Impella LD devices in patients experiencing hemodynamic compromise/cardiogenic shock post-cardiac surgery. Cardiac output (CO), cardiac index (CI), mean arterial pressure (MAP), cardiac power output (CPO), cardiac power index (CPI) and pulmonary artery diastolic blood pressure (PAd) measurements were collected. The data collected showed an immediate improvement of the hemodynamics of PCCS patients post device implant, as shown in Figure 6.25. In addition, concomitantly, as patients' hemodynamics improved, a rapid and sustained weaning of inotropic and pressor support was also observed, as given Figure 6.26.

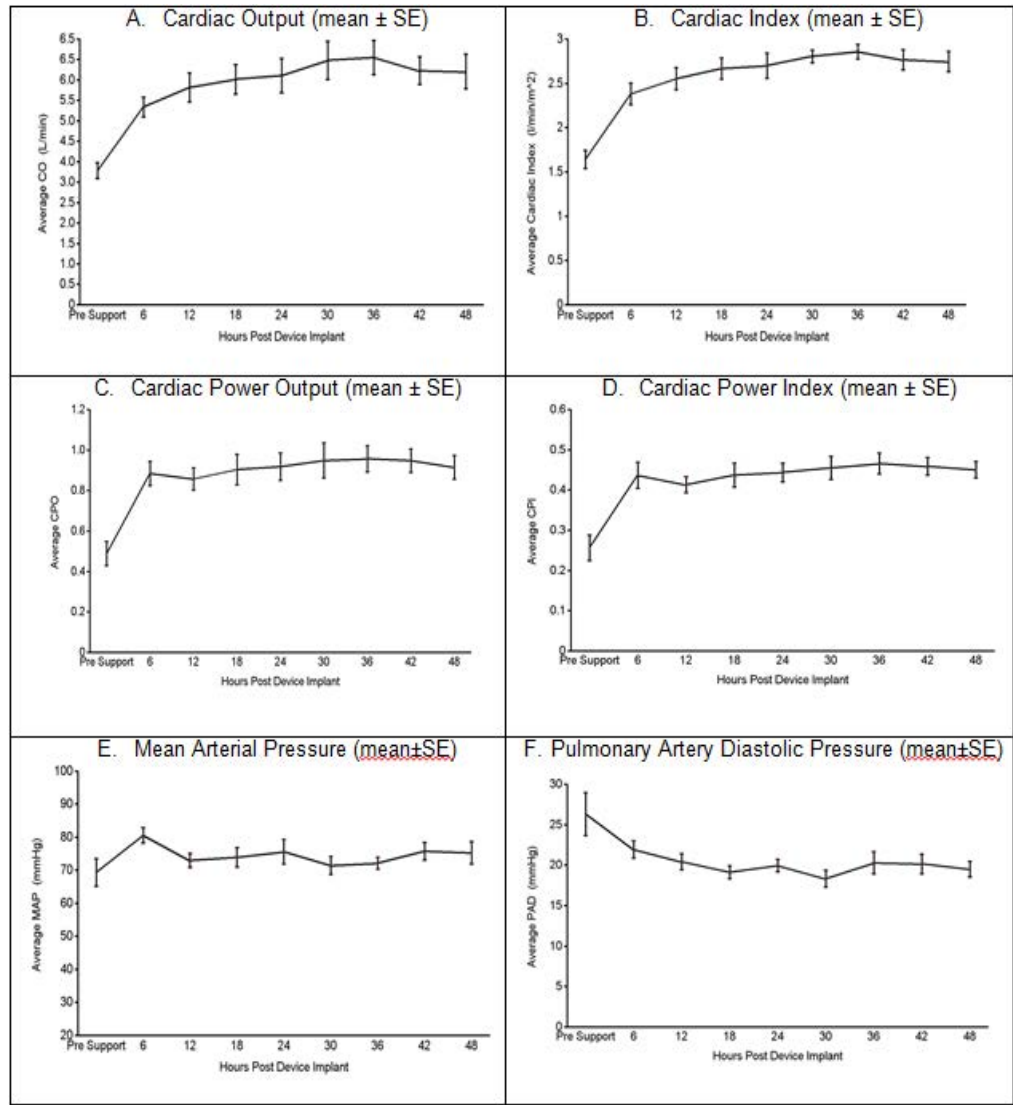

Figure 6.25 Improvement in Patient Hemodynamics (from Baseline to 48hrs Post Device Implant) for RECOVER I Patients

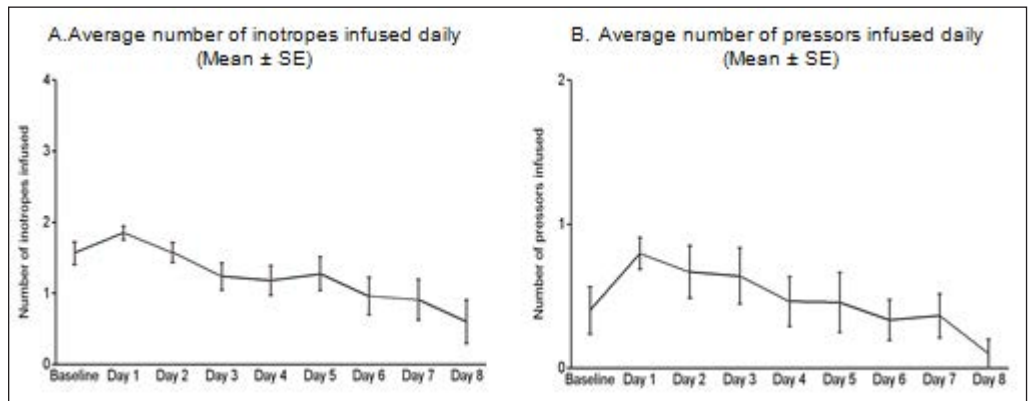

Figure 6.26 Decrease in Inotropes and Pressors (Post-Device Placement) for RECOVER I Patients

Additional hemodynamic and other clinical data was provided from both an FDA-approved, prospective, randomized study (PROTECT II) and real-world use data to further corroborate the hemodynamic benefits afforded by use of the Impella devices.

LITERATURE REVIEW

The literature review provided has three components. The first component is a review and characterization of the use of Impella to treat AMICS patients. The second component is a comparison of the results of the Impella literature review to a literature review of Abiomed's PMA-approved surgical VADs (the BVS and AB5000) in AMICS. The third component is a literature review of the use of ECMO in this population, since ECMO is used as an alternative device to support these patients as well, albeit off-label.

The Impella review encompassed a large body of scientific evidence with over 315 publications available for review. The filtering of these publications resulted in over 692 patients in 17 publications for the relevant use of Impella devices, which included 469 patients in 9 publications treated for this specific proposed indication for use. The literature review provides further insight into the use of the Impella devices in routine clinical practice.

The literature analysis shows that AMICS patients, who are deemed to require emergent hemodynamic support, are, in general, older and present with high-risk comorbidities, poor functional status and greatly depressed cardiac function. Overall, the use of Impella devices to support AMICS patients appears to be safe and effective, based on the studies published in the literature. The survival rates and morbidities also appear to be favorable for use of the Impella devices as compared to the surgical VADs.

The review of ECMO in these same patients yielded a mean survival to either discharge of 30 days at 43% (range 29% to 59%) representing 6 studies and over 265 patients. The results of the ECMO review indicate that the use of ECMO, which is a much more invasive system, yielded a higher morbidity profile during support than use of the less-invasive Impella devices for a potential comparable, or less favorable, survival outcome.

Overall, the literature analysis provides further reasonable assurance of safety and effectiveness of the Impella devices in the proposed indications for use.

CARDIAC SHOCK AFTER OPEN HEART SURGERY - SUMMARY OF PRIMARY CLINICAL STUDIES

Clinical evidence was provided to support the overall safety and effectiveness of the Impella devices to treat the indications for use provided above. Specifically, the results of the RECOVER I study were provided as primary clinical evidence. RECOVER I was an FDA-approved, prospective, single-arm study that evaluated the safety, hemodynamic benefit and feasibility for the Impella 5.0 and the Impella LD in a post-cardiotomy setting.

RECOVER I was a single arm study designed to evaluate the safety, hemodynamic potency and outcomes of the Impella 5.0/Impella LD in patients presenting with cardiogenic shock or low cardiac output syndrome post-weaning from cardiopulmonary bypass. Details of the study design are below.

CLINICAL INCLUSION AND EXCLUSION CRITERIA

Inclusion Criteria

1. Signed Informed Consent
2. Age Eligible ($18 \leq \text{Age} \leq 75$)
3. Body Surface Area ($1.5 \text{ m}^2 \leq \text{BSA} \leq 2.5 \text{ m}^2$)
4. Received stable infusion of one (1) high-dose inotrope or two (2) medium-dose inotropes
5. Cardiac Index ($1.3 \text{ L/min/m}^2 \leq \text{Cardiac Index} \leq 2.2 \text{ L/min/m}^2$) after the respective minimum inotrope infusion time
6. Elevated Filling Pressures: $30 \geq \text{PCWP} \geq 20 \text{ mmHg}$ OR $35 \geq \text{PA}$
7. Diastolic $\geq 25 \text{ mmHg}$
8. Time to enrollment within 48 hours of weaning from bypass

Exclusion Criteria

1. Concomitant enrollment in another investigational device or drug trial that did not complete the required follow-up
2. $\text{BUN} \geq 100 \text{ mg/dL}$
3. Renal dysfunction
4. Hepatic dysfunction
5. Presence of any cardiac assist device (other than an IABP)
6. Right ventricular failure
7. Evidence of any vascular disease that would have precluded placement of the device (e.g., severely calcified vessel)
8. Evidence of LV or RV thrombus
9. Documented presence of aortic insufficiency
10. Aortic valve stenosis/calcification
11. Presence of mechanical aortic valve

12. Obstructive, hypertrophic cardiomyopathy
13. Evidence of uncorrected Ventricular Septal Defect or Atrial Septal Defect (VSD/ASD) or Patent Foramen Ovale (PFO)
14. Mechanical manifestation of AMI (e.g., ventricular septal rupture, papillary muscle rupture)
15. Any disorder causing fragility of blood cells or hemolysis
16. Patient actively receiving cardiopulmonary resuscitation (CPR or any resuscitative maneuver for cardiac arrest)
17. Sustained or non-sustained ventricular tachycardia ventricular fibrillation (VT/VF), unresponsive to treatment
18. Other co-morbid condition(s) that could have limited the patient's ability to participate in the study or impact its scientific integrity

Patients were assessed at 30, 60, 180 days and 1 year. During the assessments, clinical data was obtained to assess the endpoints below.

CLINICAL ENDPOINTS

Primary Endpoints

Safety - Frequency of Major Adverse Events:

- Death
- Stroke

Efficacy - Survival to:

- Recovery defined as 30-day survival post-explant or hospital discharge (whichever is longer) with no other mechanical support or IABP
- Bridge-to-other-therapy defined as induction of anesthesia for surgery for cardiac transplantation OR approved Ventricular Assist Device

Secondary Endpoints

Safety

- Frequency of other Adverse Events (at 30, 60, 180, 365 days)

Efficacy

- Improved Hemodynamics– Post-device implant improvements in hemodynamics were to be demonstrated without additional adjunctive inotropic or vasoactive medications versus baseline
- Device Placement and Technical Success
- Time-to-Recovery
- Reduction in Inotropic/Pressor Support

ACCOUNTABILITY OF PMA COHORT

The study enrolled 17 patients at 7 enrolling sites from October 18, 2006 to June 4, 2008. The overall enrollment for the RECOVER I trial is shown in Figure 6.27.

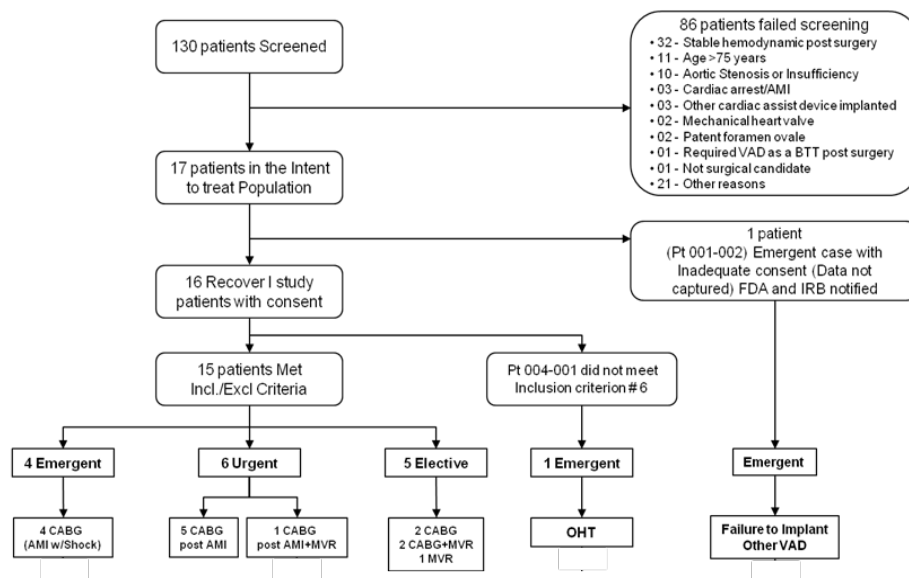

Figure 6.27 RECOVER I Enrollment

AMI: Acute Myocardial Infarction; CABG: Coronary Artery Bypass Grafting; FDA: Food and Drug Administration; MVR: Mitral Valve Repair or Replacement; OHT: Orthotopic Heart Transplant; VAD: Ventricular Assist Device

STUDY BASELINE PARAMETERS

The baseline patient characteristics and hemodynamics are provided below.

Table 6.24 Baseline Patient Characteristics

Patient Characteristic	RECOVER I Patients (N=16)	[95% CI]
Age		
Mean±SD (N)	58.38±8.94 (16)	[53.61,63.14]
Gender		
Male	81.25% (13/16)	[54.35%,95.95%]
Weight (kg)		
Mean±SD (N)	90.96±23.03 (16)	[78.69,103.23]
Height (cm)		
Mean±SD (N)	174.21±10.36 (16)	[168.68,179.73]
BSA (m ²)		
Mean±SD (N)	2.05±0.28 (16)	[1.90,2.20]
Race		
Caucasian	50.00% (8/16)	[24.65%,75.35%]
African American	31.25% (5/16)	[11.02%,58.66%]
Asian Pacific	18.75% (3/16)	[4.05%,45.65%]

Table 6.24 Baseline Patient Characteristics (continued)

Patient Characteristic	RECOVER I Patients (N=16)	[95% CI]
Medical History		
CAD	81.25% (13/16)	[54.35%,95.95%]
Unstable Angina	43.75% (7/16)	[19.75%,70.12%]
Myocardial Infarction	68.75% (11/16)	[41.34%,88.98%]
CHF	75.00% (12/16)	[47.62%,92.73%]
Valve Disease	46.67% (7/15)	[21.27%,73.41%]
Pacemaker/AICD	12.50% (2/16)	[1.55%,38.35%]
Peripheral Vascular Disease	14.29% (2/14)	[1.78%,42.81%]
Prior Stroke	6.25% (1/16)	[0.16%,30.23%]
Diabetes Mellitus	37.50% (6/16)	[15.20%,64.57%]
Hypertension	62.50% (10/16)	[35.43%,84.80%]
COPD	12.50% (2/16)	[1.55%,38.35%]
NYHA Class		
I	8.33% (1/12)	[0.21%,38.48%]
II	16.67% (2/12)	[2.09%,48.41%]
III	25.00% (3/12)	[5.49%,57.19%]
IV	50.00% (6/12)	[21.09%,78.91%]
III or IV	75.00% (9/12)	[42.81%,94.51%]
Prior Cardiac Procedures		
Thrombolytic Therapy	18.75% (3/16)	[4.05%,45.65%]
PCI	33.33% (5/15)	[11.82%,61.62%]
CABG	12.50% (2/16)	[1.55%,38.35%]
Valve Surgery	0.00% (0/16)	[0.00%,20.59%]
Transplant Surgery	6.25% (1/16)	[0.16%,30.23%]
Left Ventricular Ejection Fraction (%)		
Mean±SD (N)	23.47±7.04 (15)	[19.57,27.36]
Logistic EuroScore (%)		
Mean±SD (N)	36.08±26.77 (16)	[21.82,50.34]

Table 6.25 Baseline Patient Hemodynamics

Measurements	RECOVER I Patients (N=16)	[95% CI]
Heart Rate (bpm)		
Mean±SD (N)	87.3±16.1 (16)	[78.7, 95.9]
Systolic Arterial Pressure (mmHg)		
Mean±SD (N)	105.4±20.4 (16)	[94.6, 116.3]
Diastolic Arterial Pressure (mmHg)		
Mean±SD (N)	61.0±13.9 (16)	[53.6, 68.4]
Mean Arterial Pressure (mmHg)		
Mean±SD (N)	69.3±15.0 (13)	[60.2, 78.4]
PCWP (mmHg)		
Mean±SD (N)	14.0±. (1)	N/A

Table 6.25 Baseline Patient Hemodynamics (continued)

Measurements	RECOVER I Patients (N=16)	[95% CI]
PA Systolic (mmHg)		
Mean±SD (N)	45.3±14.8 (16)	[37.4, 53.2]
PA Diastolic (mmHg)		
Mean±SD (N)	26.3±10.6 (16)	[20.7, 32.0]
Cardiac Index (l/min/m ²)		
Mean±SD (N)	1.6±0.4 (12)	[1.4, 1.9]
CVP (mmHg)		
Mean±SD (N)	13.9±6.1 (15)	[10.5, 17.2]
Number of Inotropes		
Mean±SD (N)	1.56±0.63 (16)	[1.23, 1.90]
Number of Pressors		
Mean±SD (N)	0.40±0.63 (15)	[0.05, 0.75]

SAFETY AND EFFECTIVENESS RESULTS

Data for the 16 patients, who were consented for the RECOVER I study, was analyzed. The primary endpoint (survival) was met in 88% of the cases. A Kaplan-Meier curve for survival to 1 year is provided in Figure 6.28. In addition, the implant of the Impella 5.0 and the Impella LD in RECOVER I was successful in all but one patient. The average support time was 3.7 ± 3 days, with the range of support from 1.7 days to 12.6 days. The pump provided an overall average flow during support of 3.8 ± 0.6 L/min.

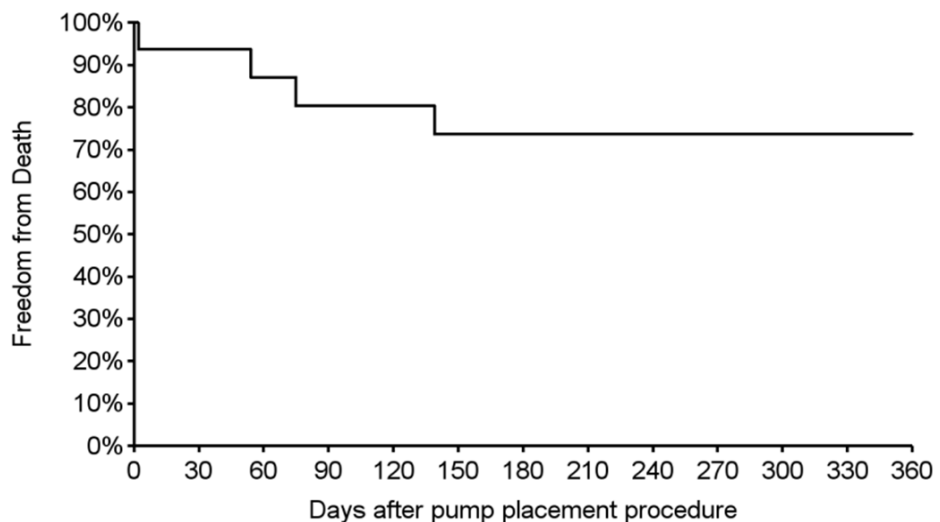

Figure 6.28 Kaplan-Meier Survival Curve for Freedom from Death (to 1 Year)

There were no Unanticipated Adverse Device Effects (UADEs) over the duration of the RECOVER I trial. There were two (2) serious adverse events (SAEs) (each affecting one (1) patient), which were adjudicated by a Medical Monitor (per protocol) as being potentially device-related. One SAE was an incidence of hemolysis, which fully resolved post-explant. A second SAE was an incidence of sepsis or bacteremia, which was treated with antibiotics and resolved.

In addition, data was obtained to evaluate the device safety with respect to its placement across the aortic valve. A total of 50 echocardiograms available on 14 subjects were analyzed by an independent CoreLab research group. The analysis showed that there was no evidence of structural damage to the heart during use or in any subsequent follow up. These results were also submitted to FDA in the 510(k) submission for the Impella 5.0 and Impella LD (K08331), which was cleared in 2009.

Overall, the RECOVER I study demonstrated that the Impella 5.0 and Impella LD could be used in the selected patient group, resulting in:

- A high survival rate of treated patients
- A consistent and reproducible hemodynamic support
- A rapid wean of patients off of inotropes and pressors
- An excellent device safety profile with a low rate of SAEs and other device-related morbidities.

DEVICE FAILURES AND REPLACEMENTS

There were no device failures or replacements reported during the study.

FINANCIAL DISCLOSURE

The Financial Disclosure by Clinical Investigators regulation (21 CFR 54) requires applicants who submit a marketing application to include certain information concerning the compensation to, and financial interests and arrangement of, any clinical investigator conducting clinical studies covered by the regulation. This clinical study included 7 investigators. Neither of the clinical investigators had disclosable financial interests/arrangements as defined in sections 54.2(a), (b), (c), and (f). The information provided does not raise any questions about the reliability of the data.

SUMMARY OF SUPPLEMENTAL CLINICAL INFORMATION

Supplemental data was provided to demonstrate safety and effectiveness of the Impella devices during use. Results from the Impella Registry for the real-world use of the Impella catheters were provided. The sponsor also provided a benchmark comparison of the Impella Registry data to a comparable registry dataset for its surgical VAD, the AB5000 Ventricle (PMA approved for a similar indication). As further evidence, a detailed literature review was provided to support the overall safety and efficacy of the Impella devices.

RESULTS

The Impella Registry is an ongoing, multi-center, retrospective, observational registry for collection of de-identified data for patients treated with the Impella 2.5, Impella CP, Impella 5.0 and Impella LD Support Systems. The registry, which was started by Abiomed in 2009, is open for participation by qualifying sites in the U.S. and Canada. Since the registry was started, to date a total 59 sites have participated. As of June 30, 2015, there were 40 open sites. The sites include high- and low-volume centers, academic (teaching) and non-academic hospitals, public and private institutions as well as for-profit and not-for-profit centers, almost entirely from the United States, thus providing a good representation of U.S. clinical practice. In addition, Abiomed used the Impella Registry as supporting evidence in its original PMA (P140003) application for the Impella 2.5 System. After reviewing the data, FDA stated (In the PMA's SSED):

“Use of the device in a comparable patient group, as collected retrospectively via Abiomed’s USpella (Impella Registry) database, showed results similar to those obtained in the PROTECT II clinical trial for overall patient outcomes and hemodynamic support during use.”

The data collection from the Impella Registry includes IRB approval, complete data monitoring, adverse events (AEs) monitoring and CEC adjudication of AEs. All data is entered electronically by the sites. For this PMA, the time during which the Impella Registry data was collected is shown in Figure 6.29. Eligible patients were those who were reported in the Impella Registry, underwent open-heart surgery and required mechanical circulatory support with Impella devices within 48 hours post-surgery.

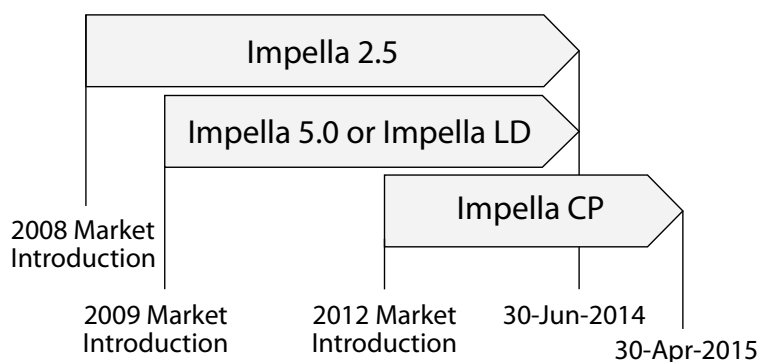

Figure 6.29 Time Intervals for Impella Implants Data Collection by Type of Device

Cases were initially identified using Abiomed's commercial patient tracking system. Using this method, seventy-seven (77) Impella cases were enrolled into the U.S. Impella Registry for this analysis. These included 19 Impella 2.5 cases, 14 Impella CP cases and 44 (combined) Impella 5.0 and Impella LD cases.

The overall results (Kaplan-Meier curve estimates) for survival (to 30 days) for the patients are shown in Figure 6.30. Figure 6.31 provides the results for the different devices used. Overall outcome results appear favorable for this sick patient group, particularly when compared to the historical results for similar patients (see the benchmark and literature review sections below).

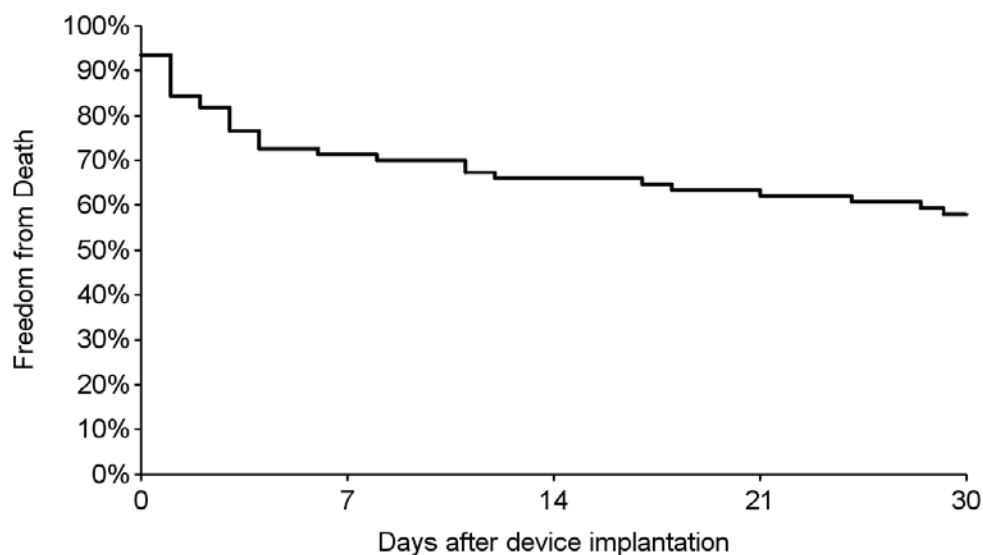

Figure 6.30 Kaplan-Meier Curve Estimates for 30-day Survival – All Patients Cohort

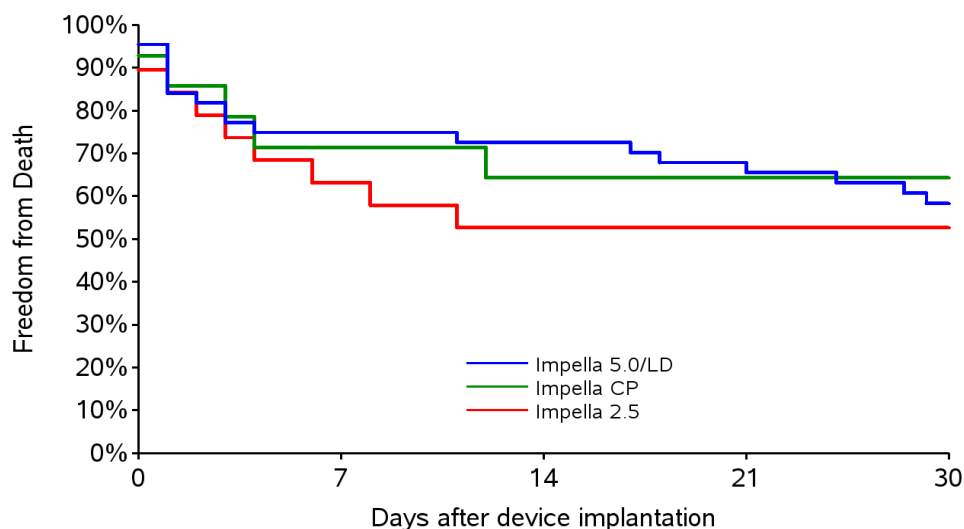

Figure 6.31 Kaplan-Meier Curve Estimates for 30-day Survival – For Different Devices

In addition, analyses were completed using two different classification schemes. In one analysis, Classification A, the patients were categorized into three (3) different groups based on an incremental ascending risk for mortality, which were: (1) Post-cardiotomy Low Cardiac Output Syndrome (LCOS), (2) Post-cardiotomy Cardiogenic Shock (PCCS-CS) and (3) Post-cardiotomy Failure to Wean (PCCS-FW). In the other analysis, Classification B, which was specifically requested by the FDA, the patients were categorized into three (3) different groups, to evaluate separately patients that received Impella before, during the operating time (during the surgical procedure) and after the surgery. The groups included in each category are shown in Figure 6.32.

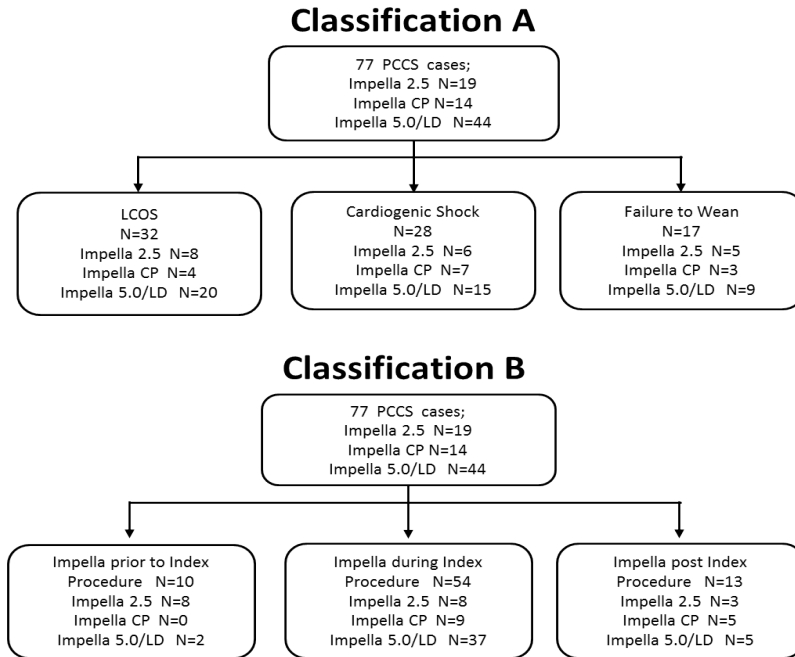

Figure 6.32 Groups Used for Each Classification Analysis

For Classification A, the overall results (Kaplan-Meier curve estimates) for survival (to 30 days) for the patients are shown in Figure 6.33. Figures 6.34, 6.35 and 6.36 give the results for the different devices used. The results show that high-risk patients in whom hemodynamic support is initiated early prior to surgery (LCOS group) tend to do better than those without support prior to surgery and who develop cardiogenic shock post-weaning from CPB or those who cannot wean from CPB.

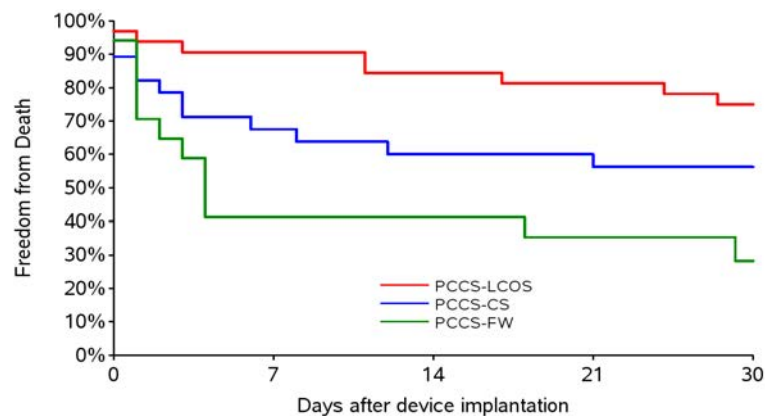

Figure 6.33 Kaplan-Meier Curve for 30-day Survival Using Classification A (All Patients)

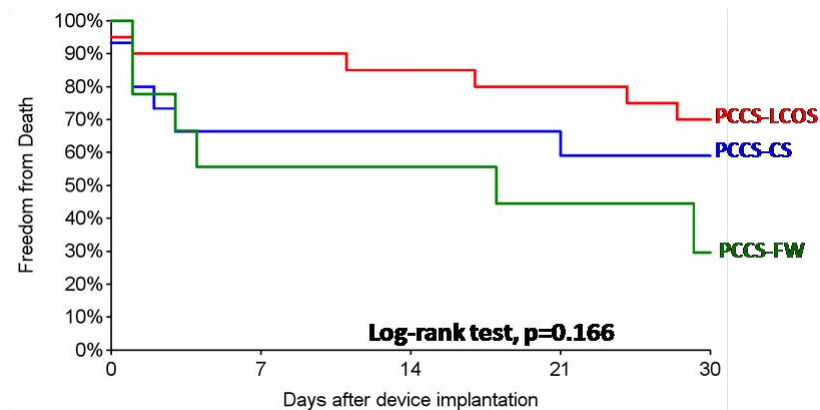

Figure 6.34 Kaplan-Meier Curve for 30-day Survival Using Classification A (Patients with Impella 5.0/ Impella LD)

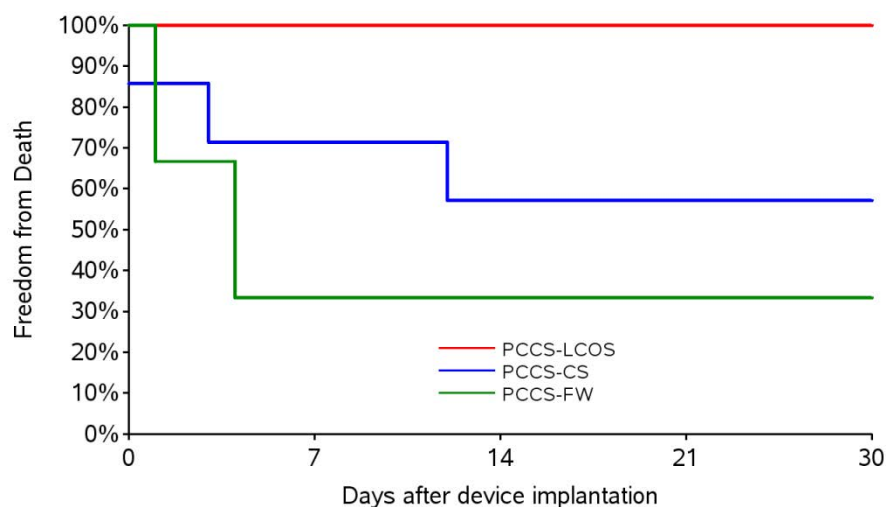

Figure 6.35 Kaplan-Meier Curve for 30-day Survival Using Classification A (Patients with Impella CP)

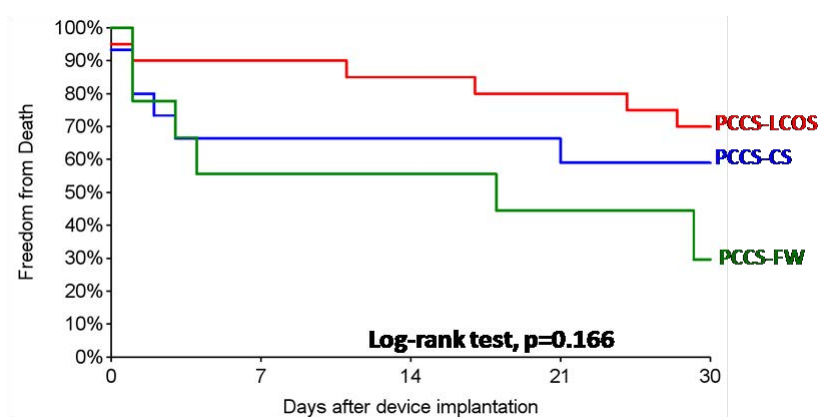

Figure 6.36 Kaplan-Meier Curve for 30-day Survival Using Classification A (Patients with Impella 2.5)

For Classification B, the overall results (Kaplan-Meier curve estimates) for survival (to 30 days) for the patients are shown in Figure 6.37. Figures 6.38, 6.39 and 6.40 give the results for the different devices used. Using this classification, the trend suggest that patients with support prior to the procedure have better outcomes, which mirrors the results observed with Classification A

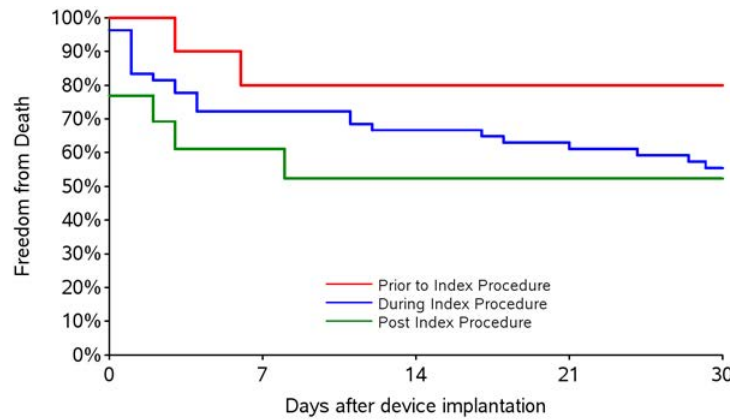

Figure 6.37 Kaplan-Meier Curve for 30-day Survival Using Classification B (All Patients)

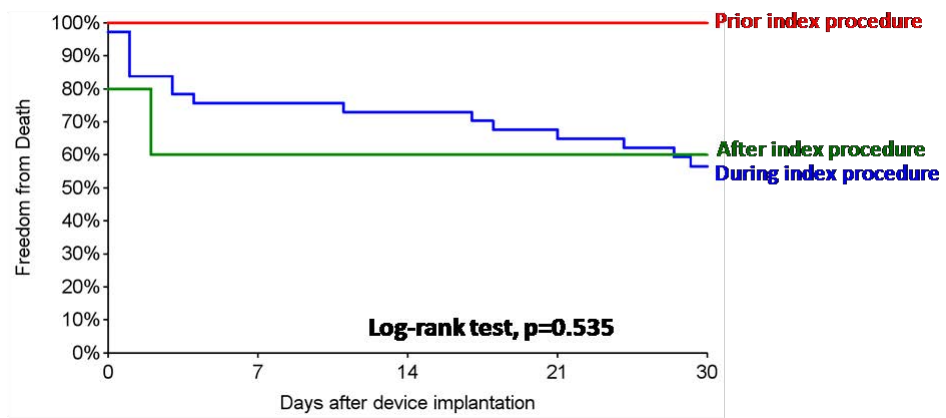

Figure 6.38 Kaplan-Meier Curve for 30-day Survival Using Classification B (Patients with Impella 5.0/ Impella LD)

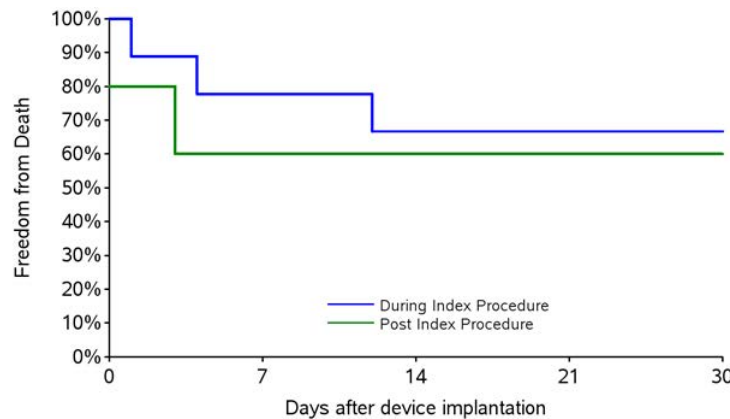

Figure 6.39 Kaplan-Meier Curve for 30-day Survival Using Classification B (Patients with Impella CP)

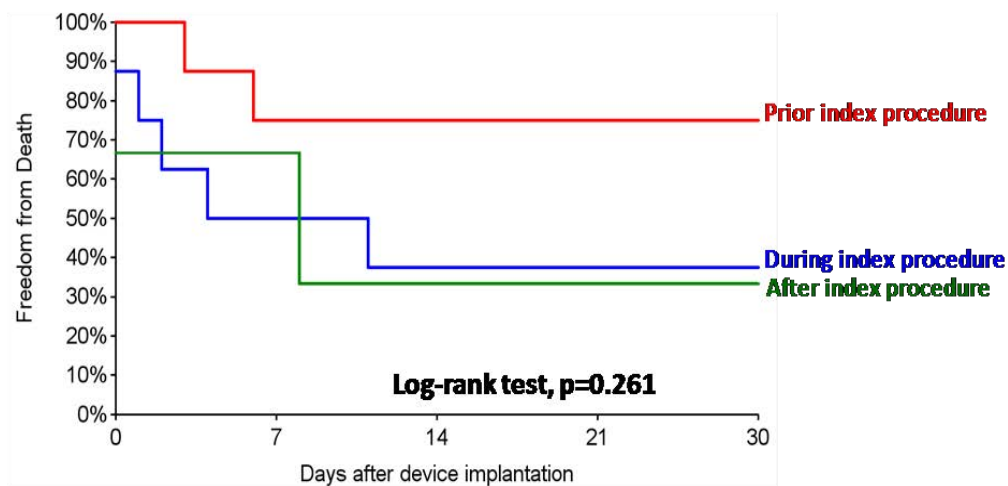

Figure 6.40 Kaplan-Meier Curve for 30-day Survival Using Classification B (Patients with Impella 2.5)

The Impella Registry data provides a real-world perspective on the use of the device in routine practice in the proposed clinical setting for the Impella devices. Although some limitations exist with respect to the interpretation of some of the data, the Impella Registry data showed the following:

- Patients that require hemodynamic support in the setting of PCCS are sick and present with a broad spectrum of pre-existing co-morbidities and risk factors
- The overall outcomes are favorable
- Despite the limited sample size, the data suggests that Impella 5.0 and Impella LD patients do somewhat better than Impella 2.5 (in the proposed clinical setting)

In order to provide a benchmark for the Impella devices in a comparable clinical setting, Abiomed analyzed the results from its real-world registry for the AB5000 Ventricle. The AB5000 Ventricle was PMA approved (P900023/S038) in 2003 as a temporary VAD for use to treat PCCS. The AB5000 Registry was a retrospective registry, which included data collected from U.S. sites between October 3, 2003 and December 11, 2007. The AB5000 Registry included IRB approval and data for demographics, procedural and hemodynamic characteristics, outcomes and adverse events.

To better match the two cohorts, AB5000 patients who either received bi-ventricular or right ventricular support were excluded from the benchmark analysis. The AB5000 Registry included 1234 patients (387 of which received only LVAD). Of those patients, 89 were classified as PCCS patients; however, only 79 cases had enough data to confirm the severity of the presentation (to serve as the AB5000 benchmark cohort against the Impella Registry cohort). The Impella Registry benchmark included Impella 5.0/Impella LD patients that presented either with PCCS-CS or PCCS-FW. The LCOS patients were excluded from the Impella cohort so the analysis is conservative (considering the invasiveness of the AB5000, it is very unlikely that it (i.e., the AB5000) was used for LCOS patients). The Impella 2.5 and Impella CP patients were also excluded because it was felt that both the AB5000 and the Impella 5.0/Impella LD provide full flow (as opposed to the Impella 2.5 and Impella CP that provide partial flow). The selection of cases for the benchmark comparison is provided schematically in Figure 6.41.

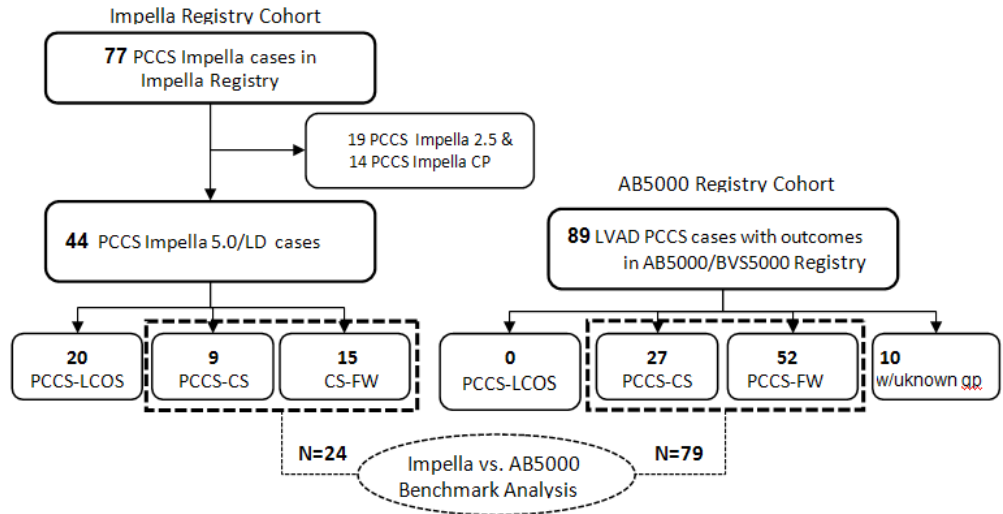

Figure 6.41 Flow Diagram of the Distribution of the AB5000 LVAD PCCS Patient Cohort

The benchmark analysis included the overall survival to 30 days and to discharge in the PCCS. The 30-day Kaplan-Meier estimates are provided in Figure 6.42. For the survival to discharge, the Impella survival rate (50%) was statistically higher than the AB5000 survival (15%, $p=0.002$), as shown in Table 6.26.

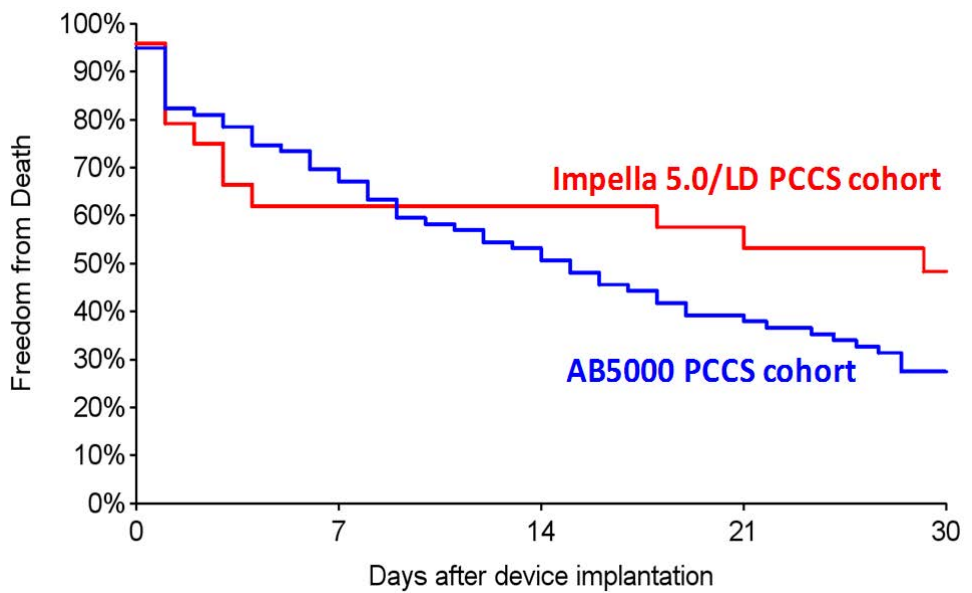

Figure 6.42 Kaplan-Meier Curve Estimates for 30-day Survival

Table 6.26 Site-reported adverse events (to discharge) by classification

In-Hospital Adverse Events	Impella 5.0/Impella LD Patients (n=24)	AB5000 Patients (n=79)	p-value
Death	50.00% (12/24)	84.81% (67/79)	0.002
CVA/Stroke	4.17% (1/24)	20.25% (16/79)	0.112
TIA	0.00% (0/24)	2.53% (2/79)	1.000
Acute Renal Dysfunction/Failure	41.67% (10/24)	29.11% (23/79)	0.318
Hemolysis	8.33% (2/24)	6.33% (5/79)	0.663
Acute Hepatic Failure	16.67% (4/24)	18.99% (15/79)	1.000
Bleeding	45.83% (11/24)	41.77% (33/79)	0.815
Infection	37.50% (9/24)	22.78% (18/79)	0.187
Supraventricular Arrhythmia	12.50% (3/24)	7.59% (6/79)	0.432
Respiratory Dysfunction/Failure	33.33% (8/24)	17.72% (14/79)	0.153
Sepsis	4.17% (1/24)	0.00% (0/79)	0.068
Multisystem Organ Failure	8.33% (2/24)	35.44% (28/79)	0.010
Other	29.17% (7/24)	45.57% (36/79)	0.167

CVA: Cerebrovascular accident; TIA: Transient Ischemic Attack

In addition, the rates of site-reported in-hospital adverse events, which were captured in both registry CRFs, were compared. The results of this comparison are provided in Table 6.23. Of note, the rate of multi-system organ failure was lower in the Impella Registry PCCS group and the stroke rate was also numerically lower compared with the AB5000 PCCS benchmark cohort. The other site-reported adverse events including bleeding, hemolysis and infection were comparable between the two cohorts. Given the clinical presentation of these patients (all undergoing major cardiac surgery), similar bleeding and infection rates are expected.

Overall, Abiomed's benchmark analysis revealed that post-cardiotomy patients in the Impella Registry are comparable with the post-cardiotomy patients treated with the AB5000 device. Although the devices provided similar amount of circulatory support, it appears that the patients in the Impella Registry had better outcomes than the patients in the AB5000 Registry.

HEMODYNAMIC EFFECTIVENESS RESULTS

The Impella Catheters directly unload the left ventricle (LV) and propel blood forward, from the left ventricle into the aorta, in a manner most consistent with normal physiology. Impella provides both an active forward flow and systemic aortic pressure (AOP) contribution, leading to an effective increase in mean arterial pressure (MAP) and overall cardiac power output (CPO). Combined with LV unloading, Impella support reduces end-diastolic volume and pressure (EDV, EDP) and augments peak coronary flow, leading to a favorable alteration of the balance of myocardial oxygen supply and demand. This cascade of hemodynamic effects has been described in the literature and validated in computational modeling and a variety of pre-clinical and clinical studies.

For the RECOVER I study (see above), hemodynamic data was collected at baseline and over time to evaluate the robustness of the hemodynamic support with the Impella 5.0 and Impella LD devices in patients experiencing hemodynamic compromise or cardiogenic shock post-cardiac surgery. The data collected showed an immediate improvement of the hemodynamics of PCCS patients post device implant, as shown in Figure 6.43. In addition, concomitantly, as patients' hemodynamics improved, a rapid and sustained weaning of inotropic and pressor support was also observed, which is shown in Figure 6.44.

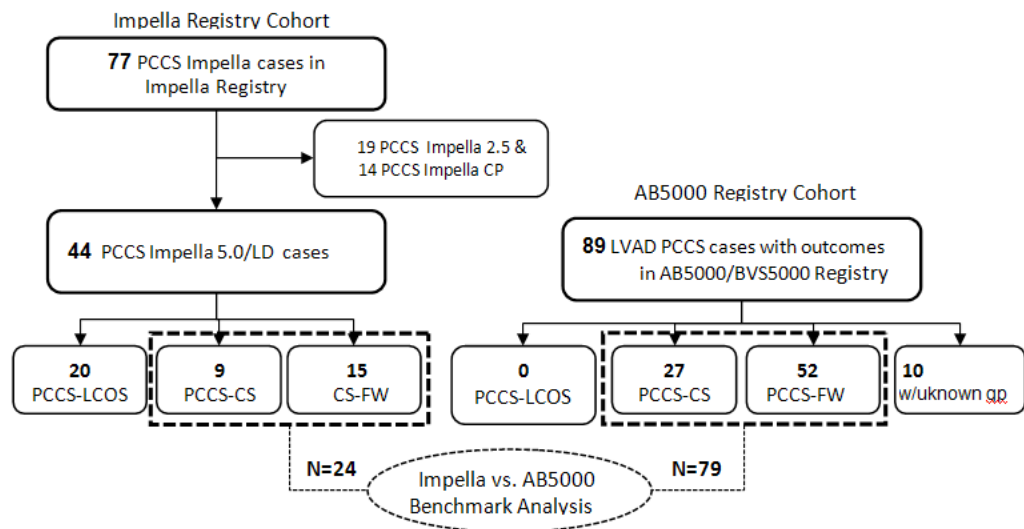

Figure 6.43 Improvement in Patient Hemodynamics (from Baseline to 48 hr Post-Device Implant) for RECOVER I Patients

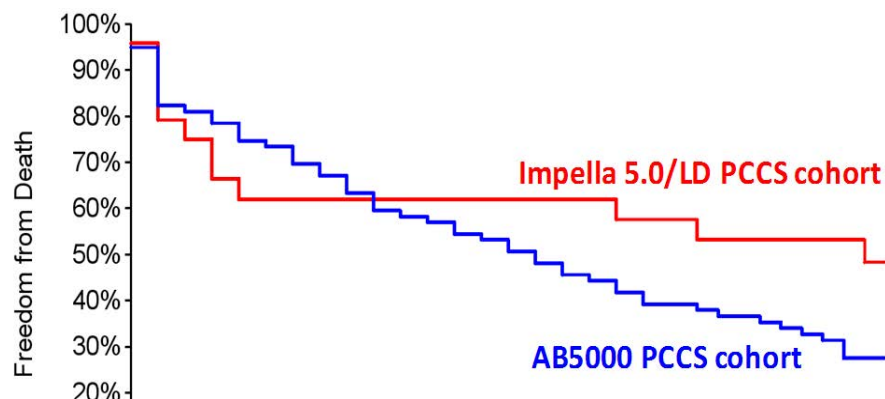

Figure 6.44 Decrease in Inotropes and Pressors (Post-Device Placement) for RECOVER I Patients

Additional prospective clinical study data was provided to demonstrate a similar hemodynamic effect for the Impella 2.5 device.

LITERATURE REVIEW

The literature review provided has three different components. The first is a review and characterization of the use of Impella in post-cardiotomy shock. The second is a review of the BVS/AB5000 in the same patient population as this device has been FDA approved for this indication. The third is a review of ECMO in this population as ECMO, even though off-label, is used as an alternate device to support these patients as well.

The Impella review encompasses a large body of scientific evidence with over 230 publications totaling over 2537 patients for the use of Impella devices. Included in this Impella PCCS analysis are 223 patients treated for the proposed indications for use. The literature review provides further insight into the use of the Impella devices in routine clinical practice. The literature analysis shows that post-surgical patients, who are deemed to require urgent hemodynamic support, are in general old and present with high-risk features and co-morbidities, poor functional status and greatly depressed cardiac function. The use of Impella devices to support these patients generally appears to be safe and effective in these studies published in the literature. Also the survival rates and morbidity profiles appear to be favorable for use of the Impella as compared to surgical VADs.

Likewise, the review of ECMO in these same patients yielded a mean survival to either discharge of 30 days at 33.9% (range 8% to 53%) representing 14 studies and over 1400 patients. ECMO is a much more invasive system and more complex to use yielding a higher morbidity profile than Impella. Overall, the literature analysis provides further reasonable assurance of safety and effectiveness of the Impella devices in the proposed indications for use.

CLINICAL EXPERIENCE OVERVIEW FOR CARIOGENIC SHOCK IN THE SETTING OF CARDIOMYOPATHY, MYOCARDITIS, AND PERIPARTUM CARDIOMYOPATHY

An additional clinical dataset was provided to demonstrate a reasonable assurance of safety and effectiveness of the Impella devices to treat a new patient population: patients suffering from ongoing cardiogenic shock that occurs in the setting of cardiomyopathy, including peripartum cardiomyopathy, or myocarditis. Specifically, clinical data from the Impella Registry for real-world use of the Impella devices to treat patients suffering from cardiomyopathy, myocarditis, or peripartum cardiomyopathy (PPCM) with ongoing cardiogenic shock was provided.

In addition, a detailed literature review of the treatment outcomes for the new patient group was used to further support the overall safety and effectiveness of the Impella devices in the new patient group.

IMPELLA REGISTRY RESULTS

The Impella Registry is an ongoing, multi-center, retrospective, observational registry for collection of de-identified data for patients treated with the Impella 2.5, Impella CP, Impella 5.0, Impella LD and Impella RP Support Systems. The registry, which was started by ABIOMED in 2009, is open for participation by qualifying sites in the U.S., Canada and Europe. A total of 88 sites have participated in the registry since its initiation. As of December 31, 2016, there were 58 open sites of which 44 were U.S. sites. All patients identified for this analysis were U.S. patients. The sites include high- and low-volume centers, academic (teaching) and non-academic hospitals, public and private institutions as well as for-profit and not-for-profit centers, almost entirely from the United States. Data are collected at all participating sites retrospectively without pre-selection of patients, and include cardiomyopathy, myocarditis, and peripartum cardiomyopathy (PPCM) patients treated with the Impella 2.5, Impella CP and Impella 5.0/ Impella LD Systems. These registry data were used as clinical data for review of the Impella Ventricular Support Systems under P140003/S018, within the context of the indications for use.

The data collection from the Impella Registry includes IRB approval, complete data monitoring, adverse events (AEs) monitoring, and CEC adjudication of major AEs. All data are entered electronically by the sites. For this submission, the time during which the Impella Registry data were collected is shown in Figure 6.45. Eligible patients were those who were reported in the Impella Registry as having presented with ongoing cardiogenic shock in the setting of cardiomyopathy, myocarditis, or peripartum cardiomyopathy, and required mechanical circulatory support with Impella devices, through June 10, 2016.

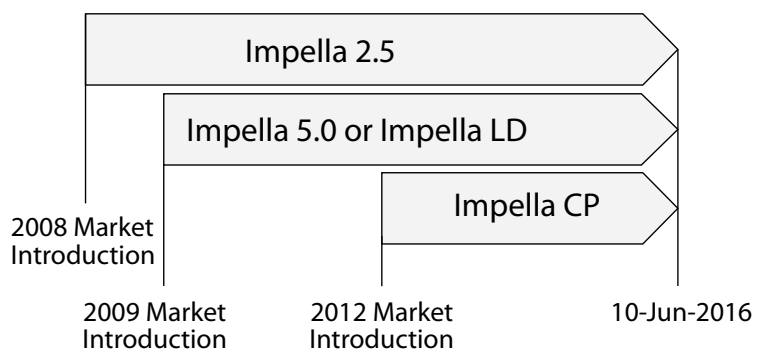

Figure 6.45 Time Intervals for Impella Implants Data Collection by Type of Device

Ninety-three (93) Impella cases were enrolled into the Impella Registry for this analysis. These included 50 cardiomyopathy cases (4 Impella 2.5 cases, 29 Impella CP cases, and 17 Impella 5.0 cases), 34 myocarditis cases (14 Impella 2.5 cases, 12 Impella CP cases and 8 Impella 5.0 cases), and 9 PPCM cases (5 Impella 2.5 cases, 2 Impella CP cases and 2 Impella 5.0 cases). The cardiomyopathy cases included the 50 most recent consecutive cardiomyopathy with ongoing cardiogenic shock cases enrolled in the Impella Registry and occurring prior to June 10, 2016. The myocarditis and PPCM cases included all such cases enrolled in the Impella Registry and occurring prior to June 10, 2016.

POPULATION DEMOGRAPHICS AND BASELINE CHARACTERISTICS

Population demographics, baseline characteristics and baseline hemodynamics are provided below. Ninety-two of the 93 patients were in cardiogenic shock at the time of Impella implant. One of the PPCM patients was not in cardiogenic shock at the time of Impella implant and the device was implanted to improve left ventricular function and prevent further hemodynamic deterioration.

Table 6.27 Demographics and Baseline Characteristics

Parameter	All Subjects (N=93)	Cardiomyopathy (N=50)	Myocarditis (N=34)	Peripartum Cardiomyopathy (N=9)
Age, years (mean +/- SD)	48 +/- 17	55 +/- 12	42 +/- 17	27 +/- 8
Male, % (N)	59 (55)	76 (38)	50 (17)	0
Left ventricular ejection fraction (LVEF), % (mean +/- SD) (N)	16 +/- 8 (77)	15 +/- 6 (39)	18 +/- 10 (29)	17 +/- 7 (9)
Number of inotropes at baseline (mean +/- SD)	2 +/- 1	3 +/- 1	2 +/- 1	2 +/- 1
Diabetes, % (N)	28% (26)	44 (22)	9 (3)	11 (1)
Smoking, % (N)	26% (24)	22 (11)	33 (11)	22 (2)
Hypertension, % (N)	53% (49)	62 (31)	44 (15)	33 (3)
Arrhythmia, % (N)	39% (36)	56 (28)	21 (7)	11 (1)
Congestive heart failure, % (N)	59% (54)	88 (44)	26 (9)	13 (1 of 8)
NYHA III/IV, % (N)	95% (41 of 43)	100 (28 of 28)	83 (10 of 12)	100 (3 of 3)
Renal insufficiency	33% (30)	54 (26)	12 (4)	0 (0)
Known history of cardiomyopathy, % (N)	52% (47)	82 (41)	15 (5 of 33)	13 (1 of 8)
Prior myocardial infarction, % (N)	11% (10)	18 (9)	3 (1)	0 (0)
Prior AICD/pacer, % (N)	33% (31)	54 (27)	9 (3)	11 (1)

Table 6.28 Baseline Hemodynamics

Parameter	All Subjects (N=93)	Cardio- myopathy (N=50)	Myocarditis (N=34)	Peripartum Cardiomyopathy (N=9)
Cardiac index (L/min/m ²) Mean +/- SD (N)	1.97 +/- 0.74 (48)	1.98 +/- 0.76 (20)	1.82 +/- 0.46 (23)	2.60 +/- 1.37 (5)
Heart rate (bpm) Mean +/- SD (N)	104.5 +/- 27.8 (89)	102.0 +/- 27.8 (48)	107.8 +/- 28.0 (32)	106.2 +/- 28.8 (9)
Systolic arterial pressure (mmHg) Mean +/- SD (N)	98.0 +/- 20.9 (90)	95.5 +/- 20.2 (48)	100.4 +/- 21.5 (33)	102.8 +/- 22.2 (9)
Diastolic arterial pressure (mmHg) Mean +/- SD (N)	65.7 +/- 15.2 (90)	65.2 +/- 16.4 (48)	66.1 +/- 13.7 (33)	66.5 +/- 16.1 (9)
Mean arterial pressure (mmHg) Mean +/- SD (N)	76.3 +/- 16.4 (90)	74.3 +/- 17.3 (48)	78.3 +/- 15.2 (33)	79.9 +/- 16.2 (9)
Pulmonary capillary wedge pressure (mmHg) Mean +/- SD (N)	25.9 +/- 9.8 (35)	27.9 +/- 14.0 (13)	25.2 +/- 6.6 (20)	21.5 +/- 3.5 (2)
Central venous pressure (mmHg) Mean +/- SD (N)	24.6 +/- 5.1 (7)	27.5 +/- 9.2 (2)	22.3 +/- 2.6 (4)	28.0 (1)

IMPELLA SUPPORT CHARACTERISTICS

Impella support characteristics are provided below (Table 6.29). Impella CP was the most-used device (46%), followed by Impella 5.0 (29%) and Impella 2.5 (25%). Femoral access site was predominantly used (70%). Mean duration of support was 123 +/- 200 hours (5±8 days) for the full cohort. For the full patient cohort, the 90th percentile of support duration was 120 hours (5 days), 233 hours (9.7 days), and 384 hours (16 days) for patients supported with the Impella 2.5, Impella CP, and Impella 5.0, respectively.

Table 6.29 Impella support characteristics

Parameter	All Subjects (N=93)	Cardio- myopathy (N=50)	Myocarditis (N=34)	Peripartum Cardiomyopathy (N=9)
Impella device type (first device)				
Impella 2.5, % (N)	25 (23)	8 (4)	41 (14)	56 (5)
Impella CP, % (N)	46 (43)	58 (29)	35 (12)	22 (2)
Impella 5.0, % (N)	29 (27)	34 (17)	24 (8)	22 (2)
Impella access (% femoral), % (N)	70 (65)	64 (32)	79 (27)	75 (6)
Duration of device support, hours (mean +/- SD) (N)	123 +/- 200 (80)	115 +/- 101 (46)	91 +/- 74 (28)	338 +/- 670 (6)
90th percentile of support duration				
Impella 2.5, hours	120	78	72	120
Impella CP, hours	233	233	72	241
Impella 5.0, hours	384	384	1704	216

SAFETY AND EFFECTIVENESS RESULTS

Outcomes Summary

Outcomes were defined as survival to discharge and survival to 30 days after device implant. Survival to discharge and patient cardiac status at discharge for the full patient cohort, and all three cohorts separately, are shown in Figures 6.46-6.49.

For the full patient cohort, 54 patients (58%) were either discharged alive (N=43, 46%) or transferred on Impella support to another medical facility for escalation of care (N=11, 12%); 39 (42%) expired during index hospitalization (Figure 6.46A). Of the 43 patients discharged alive, 29 recovered their cardiac function (67% of the discharged patients), 10 received a durable VAD (23% of the discharged patients), and 4 received a heart transplant (9% of the discharged patients) (Figure 6.46B).

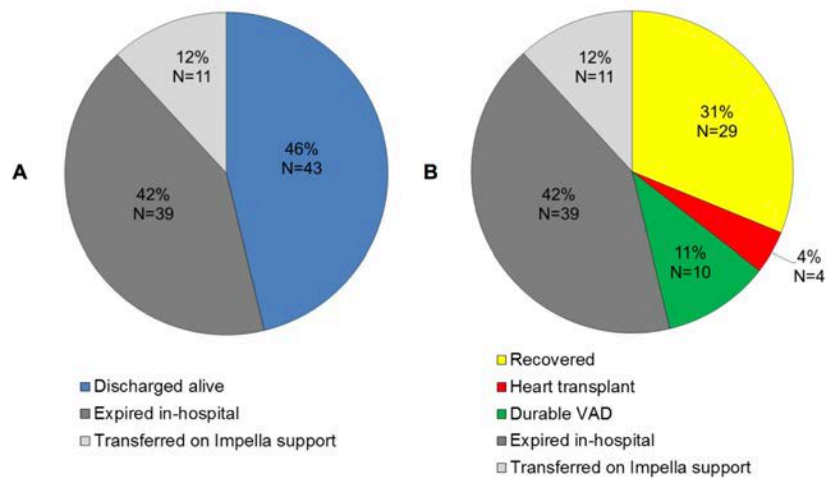

Figure 6.46 Survival to Discharge (A) and Patient Status at Discharge (B) – All Patients (N=93)

For the cardiomyopathy patients, 25 patients were either discharged alive (N=22, 44%) or transferred on Impella support to another medical facility for escalation of care (N=3, 6%); 25 (50%) expired during index hospitalization (Figure 6.47A). Of the 22 patients discharged alive, 10 recovered their cardiac function, 9 received a durable VAD, and 3 received a heart transplant (Figure 6.47B).

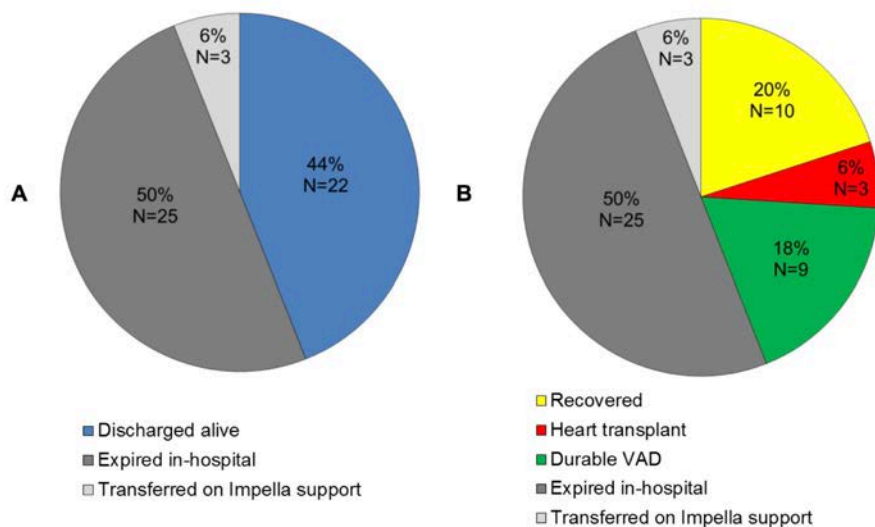

Figure 6.47 Survival to discharge (A) and patient status at discharge (B) – Cardiomyopathy patients (N=50)

For the myocarditis patients, 21 patients were either discharged alive (N=16, 47%) or transferred on Impella support to another medical facility for escalation of care (N=5, 15%); 13 (38%) expired during index hospitalization (Figure 6.48A). Of the 16 patients discharged alive, 15 recovered their cardiac function and one received a heart transplant (Figure 6.48B).

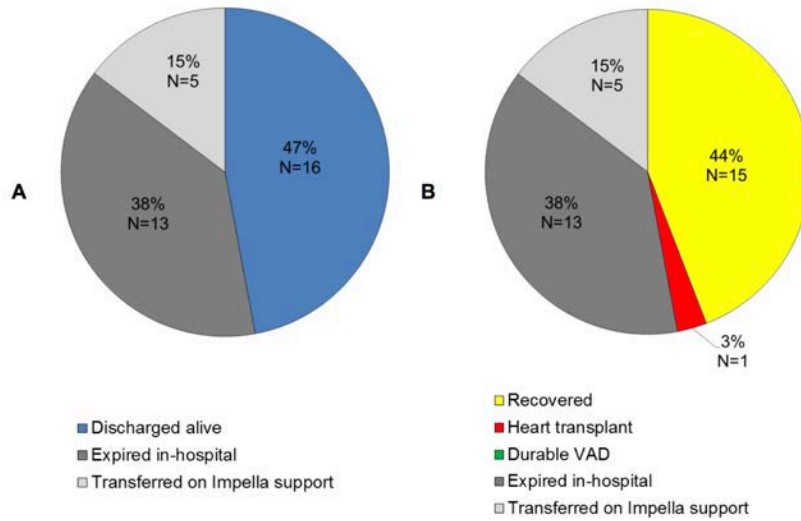

Figure 6.48 Survival to Discharge (A) and Patient Status at Discharge (B) – Myocarditis Patients (N=34)

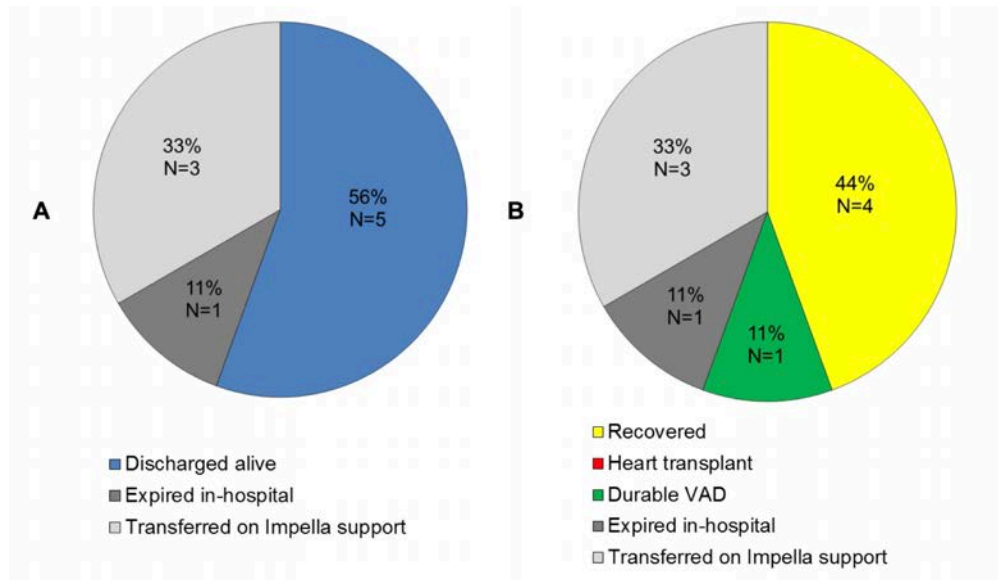

Figure 6.49 Survival to Discharge (A) and Patient Status at Discharge (B) – PPCM Patients (N=9)

PATIENT HEMODYNAMICS

Hemodynamic parameters on Impella support compared to baseline are shown in Table 6.30. Impella support significantly increased cardiac index and systolic, diastolic, and mean arterial blood pressure, and reduced pulmonary capillary wedge pressure, consistent with previous reports.

Table 6.30 Comparison of Hemodynamics Pre-Support and on-Support (Paired Data)

Parameter	Pre-Support (N=93)	On-Support (N=93)	P-value
Cardiac index (L/min/m ²) Mean +/- SD (N)	1.93 +/- 0.51 (25)	2.27 +/- 0.83 (25)	0.05
Heart rate (bpm) Mean +/- SD (N)	104.8 +/- 28.7 (75)	110.6 +/- 41.5 (75)	0.24
Systolic arterial pressure (mmHg) Mean +/- SD (N)	97.5 +/- 18.8 (71)	104.4 +/- 23.0 (71)	0.02
Diastolic arterial pressure (mmHg) Mean +/- SD (N)	65.2 +/- 13.8 (70)	70.8 +/- 18.4 (70)	0.04
Mean arterial pressure (mmHg) Mean +/- SD (N)	75.5 +/- 15.0 (72)	83.1 +/- 18.4 (72)	0.003
Pulmonary capillary wedge pressure (mmHg) Mean +/- SD (N)	23.5 +/- 7.3 14)	18.7 +/- 6.7 (14)	0.02
Central venous pressure (mmHg) Mean +/- SD (N)	24.6 +/- 6.2 (5)	19.5 +/- 10.4 (5)	0.34

IN-HOSPITAL ADVERSE EVENTS

Site-reported in-hospital adverse events are shown in Table 6.31. There were no valve injuries or valve dysfunction adverse events reported. The major complications reported for the full cohort included cerebrovascular accident (4%), acute renal dysfunction (35%), acute hepatic failure (5%), hemolysis (13%), bleeding requiring transfusion (10%), anemia requiring transfusion (11%), infection (13%), limb ischemia (4%), vascular complication with (3%) or without (4%) surgery, respiratory dysfunction/failure (4%), and ventricular arrhythmia (9%). Based on the site-reported data (local PI assessment of event causality), only a fraction of these rates were attributed to the Impella device and the events resolved without residual effect in most of the cases, unless the event of death occurred. Overall, the results did not show any evidence of increased morbidity associated with the Impella support in cardiomyopathy, myocarditis, and PPCM patients.

Table 6.31 Site-Reported Adverse Events (to Discharge)

In-Hospital Adverse Events	All Subjects (N=93)	Cardiomyopathy (N=50)	Myocarditis (N=34)	Peripartum Cardiomyopathy (N=9)
Death	42% (39/93)	50% (25/50)	38% (13/34)	11% (1/9)
Cerebrovascular Accident (CVA)/ Stroke	4% (4/93)	4% (2/50)	6% (2/34)	0% (0/9)
Transient Ischemic Attack (TIA)	0% (0/93)	0% (0/50)	0% (0/34)	0% (0/9)
Acute Renal Dysfunction/Failure	35% (33/93)	30% (15/50)	47% (16/34)	22% (2/9)
Acute Hepatic Failure	5% (5/93)	6% (3/50)	6% (2/34)	0% (0/9)
Hemolysis	13% (12/93)	16% (8/50)	12% (4/34)	0% (0/9)
Valve Injury (Any Valve)	0% (0/93)	0% (0/50)	0% (0/34)	0% (0/9)
Anemia Requiring Transfusion	11% (10/93)	2% (1/50)	18% (6/34)	33% (3/9)
Bleeding Requiring Transfusion	10% (9/93)	2% (1/50)	21% (7/34)	11% (1/9)
Infection	13% (12/93)	12% (6/50)	9% (3/34)	33% (3/9)
Limb Ischemia	4% (4/93)	0% (0/50)	9% (3/34)	11% (1/9)
Vascular Complication Requiring Surgery	3% (3/93)	2% (1/50)	3% (1/34)	11% (1/9)
Vascular Complication Without Surgery	4% (4/93)	4% (2/50)	3% (1/34)	11% (1/9)
Respiratory Dysfunction/Failure	4% (4/93)	2% (1/50)	6% (2/34)	11% (1/9)
Ventricular Arrhythmia	9% (8/93)	2% (1/50)	15% (5/34)	22% (2/9)

There were 39 in-hospital deaths (42%). The causes of death for each subgroup are categorized in Table 6.32. The majority of the deaths (N=25, 64%) were attributed to heart failure or cardiogenic shock.

Table 6.32 Causes of In-Hospital Death

Cause of Death	Impella Registry Population		
	Cardiomyopathy (N=50)	Myocarditis (N=34)	Peripartum Cardiomyopathy (N=9)
Heart Failure or Cardiogenic Shock	30% (15)	26.47% (9)	11.11% (1)
Myocardial Infarction	4% (2)	0	0
CVA/Stroke	0	2.94% (1)	0
Procedural Complication	0	2.94% (1)	0
Heart Failure with MSOF	16% (8)	2.94% (1)	0
Unknown		2.94% (1)	0
Total	50% (25)	38.23% (13)	11.11% (1)

CVA – cerebrovascular accident; MSOF – multisystem organ failure

RELATEDNESS TO THE DEVICE AND PROCEDURE

The Clinical Events Committee (CEC) determined the potential relationship to the device (Table 6.33) and procedure (Table 6.34) for each death. All deaths were adjudicated by the CEC as not related to the Impella device, in any degree.

Two deaths in the myocarditis cohort were adjudicated by the CEC as probably related to the procedure. One myocarditis patient underwent an endomyocardial biopsy complicated by perforation of the inferior free wall of the right ventricle leading to cardiac tamponade and requiring emergent mediastinal exploration to suture the laceration and stop the bleeding. The patient expired four days later during the index hospitalization, and this death was adjudicated as probably related to the endomyocardial biopsy procedure. A second myocarditis patient was supported initially with an Impella CP but did not significantly improve. Consequently, the patient was escalated to an AB5000 LVAD. While on LVAD support, the patient developed multiple complications and support was withdrawn upon the request from the patient's family. This death was adjudicated as probably related to the LVAD implant procedure.

Table 6.33 In-Hospital Deaths CEC-Adjudicated as Related to the Device

Deaths: CEC Device Relatedness	Definite	Probable	Possible	Remote	Not-Related	Unknown	Total
Cardiomyopathy	0	0	0	0	25	0	25
Myocarditis	0	0	0	0	13	0	13
PPCM	0	0	0	0	1	0	1

Table 6.34 In-hospital Deaths CEC-Adjudicated as Related to the Procedure

Deaths: CEC Device Relatedness	Definite	Probable	Possible	Remote	Not-Related	Unknown	Total
Cardiomyopathy	0	0	0	0	25	0	25
Myocarditis	0	2	0	0	11	0	13
PPCM	0	0	0	0	1	0	1

PATIENT SURVIVAL AT 30 DAYS

The overall results (Kaplan-Meier curve estimates) for 30-day survival for the patients are shown in Figure 6.53 (full patient cohort), Figure 6.51 (cardiomyopathy patients), Figure 6.52 (myocarditis patients), and Figure 6.50 (PPCM patients). Overall outcome results appear favorable for this sick patient group, particularly when compared to the published results for similar patients (see the literature review section below).

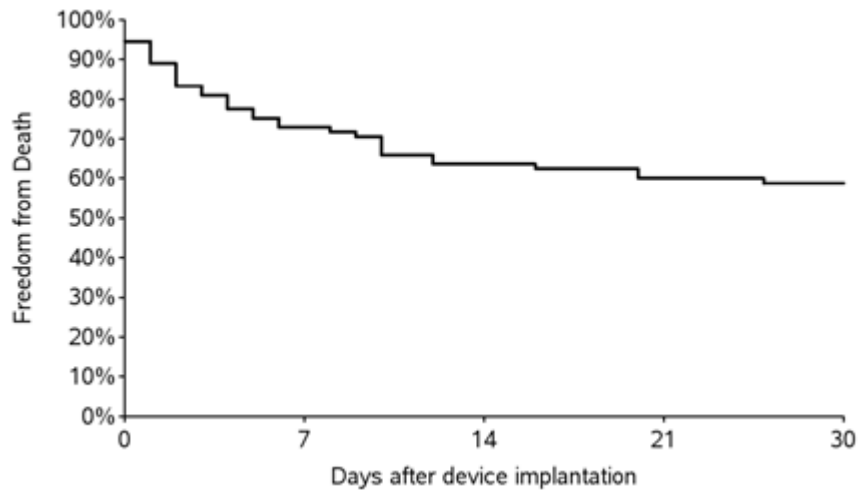

Figure 6.50 Kaplan-Meier Curve Estimates for 30-day Survival – All Patients (N=93)

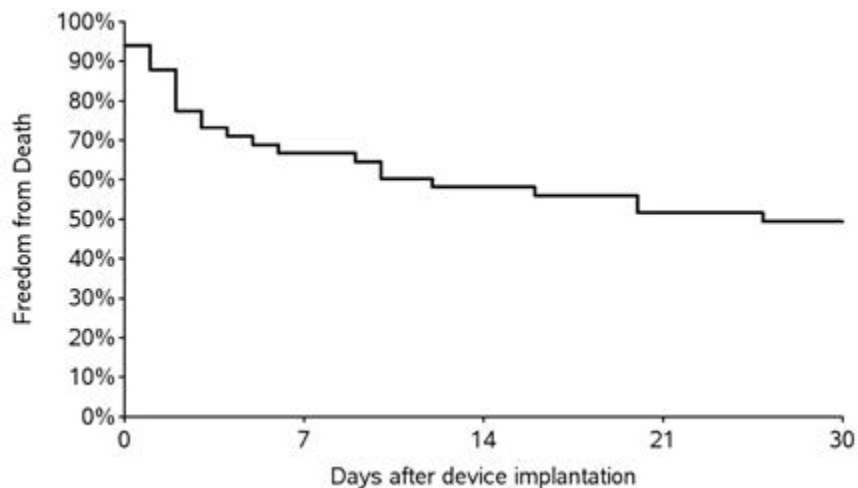

Figure 6.51 Kaplan-Meier curve estimates for 30-day survival – cardiomyopathy patients (N=50)

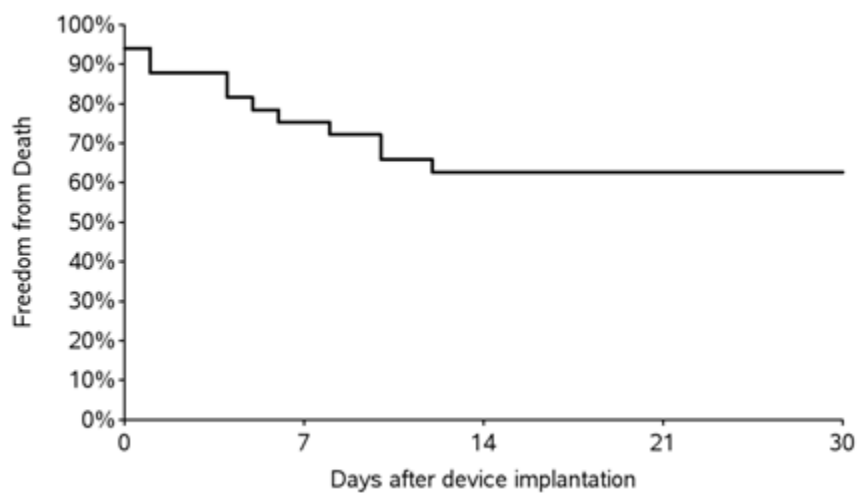

Figure 6.52 Kaplan-Meier Curve Estimates for 30-day Survival – Myocarditis Patients (N=34)

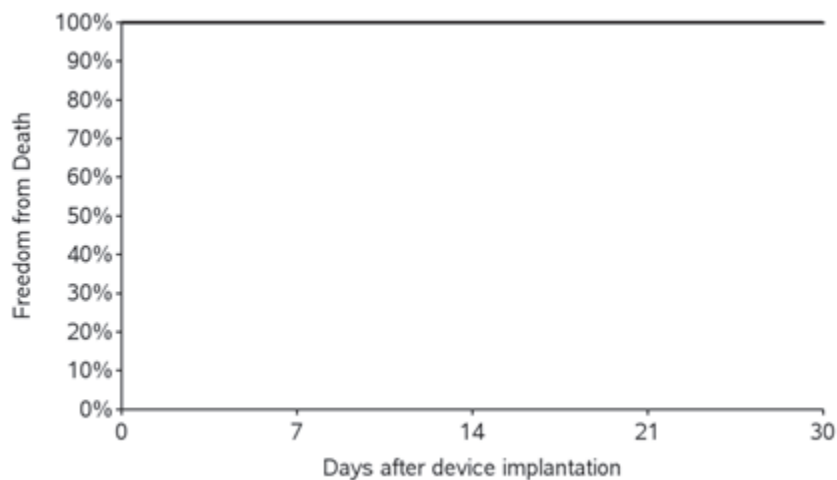

Figure 6.53 Kaplan-Meier Curve Estimates for 30-day survival – PPCM Patients (N=9)

SUMMARY OF THE IMPELLA REGISTRY DATA

The Impella Registry data provides real-world perspective on the use of Impella devices in routine clinical practice in cardiomyopathy, myocarditis, and peripartum cardiomyopathy patients with ongoing cardiogenic shock. In spite of inherent limitations due to the retrospective nature of data collection, the Impella Registry data shows the following:

- Cardiomyopathy, myocarditis, and PPCM patients treated with Impella in routine clinical practice have severe LV dysfunction and are in cardiogenic shock refractory to conventional therapy, requiring immediate intervention to prevent death.
- The use of Impella devices improves hemodynamic status, stabilizing the patient and providing adequate hemodynamic support during the acute phase with a significant increase in cardiac index and systolic, diastolic, and mean arterial pressure, and a significant reduction in pulmonary capillary wedge pressure from baseline. This allows the myocardium to rest and recover, and improves end organ perfusion to bridge the patient to recovery. For patients in whom native heart recovery is not immediately evident, Impella provides a bridge to the next therapy (or bridge to decision), which could be a higher level of support with durable surgical VADs or heart transplantation. In this combined cohort, the majority of patients who survived to discharge recovered their heart function.
- Mean duration of support was 123 +/- 200 hours (5±8 days) for the entire cohort. For the entire patient cohort, the 90th percentile of support duration was 120 hours (5 days), 233 hours (9.7 days), and 384 hours (16 days) for patients supported with the Impella 2.5, Impella CP, and Impella 5.0, respectively.
- The outcomes of cardiomyopathy, myocarditis, and PPCM patients supported with Impella devices are similar to the outcomes observed in the patients supported with other circulatory support modalities (see Literature Review). The 30-day survival rates were 59% for the full patient cohort; 49% for the cardiomyopathy patients; 63% for the myocarditis patients; and 100% for the PPCM patients. The survival-to-discharge rates were 58% for the full patient cohort; 50% for the cardiomyopathy patients; 62% for the myocarditis patients; and 89% for the PPCM patients. These rates are similar to the corresponding survival-to-discharge rates observed in ischemic cardiogenic shock due to acute myocardial infarction (45.7%) or post-cardiotomy (58.4%) supported with Impella.
- The safety of the devices is favorable with regard to a broad range of adverse events that were monitored. The use of the Impella is safe and effective to treat ongoing cardiogenic shock secondary to cardiomyopathy, myocarditis, or peripartum cardiomyopathy.

DEVICE FAILURES AND REPLACEMENTS

There was one device failure reported during the study. One myocarditis patient experienced device failure after 12 days on support. The device was explanted without clinical sequelae. No device failures were reported for the cardiomyopathy or PPCM patients. One cardiomyopathy patient underwent a device replacement after the initial device migrated and could not be repositioned across the aortic valve.

LITERATURE REVIEW

ABIOMED conducted a comprehensive literature review on the use of mechanical circulatory support in the setting of cardiogenic shock secondary to cardiomyopathy, myocarditis, or PPCM, to further enhance the body of evidence that will support the reasonable assurance of safety and effectiveness argument for the Impella family of devices. The literature review includes two parts: 1) a review of the literature for Impella use in the above setting, along with the FDA approved AB/BVS5000 VAD use in the same setting; and 2) a review of the literature for the use of other mechanical circulatory support devices in the same setting.

Impella

The Impella review yielded 31 publications for cardiomyopathy (16 publications), myocarditis (13 publications, 1 of which was also in the cardiomyopathy group), for PPCM (3 publications). The publications were either case reports on single patients (21 publications), single-center studies on hemodynamic support using Impella in the setting of cardiogenic shock where one or more of the patients presented with cardiomyopathy or myocarditis as the underlying cause (9 publications), or multi-center series on the use of Impella devices specifically for cardiomyopathy with ongoing cardiogenic shock (1 publication). For the cardiomyopathy patients, survival to explant was 72% (78 of 109). Ten of the reported cardiomyopathy patients were also included in the Impella Registry cohort. For the myocarditis patients, survival to explant was 71% (10 of 14 patients). One of the reported myocarditis patients was also included in the Impella Registry cohort. For the PPCM patients, recovery and survival to explant was 100% (3 patients).

Surgical VAD

The BVS/AB5000 review yielded only one publication, a retrospective, multi-center study using data collected in the ABIOMED voluntary registry, on 11 patients supported with the BVS 5000 for cardiogenic shock secondary to acute myocarditis. The BVS/AB5000 System is the only FDA-approved system for use in patients suffering from acute cardiac disorders such as viral myocarditis. Survival to explant was 82%, with high rates of bleeding (73%), stroke (27%) and infection (18%).

Other Mechanical Support Devices

The review on the use of other MCS devices in cardiomyopathy or myocarditis yielded 18 retrospective, single-center (n=16) or multi-center (n=2) studies on patients who required mechanical circulatory support due to cardiogenic shock in the setting of cardiomyopathy or myocarditis (910 patients total). Most studies reported the use of ECMO only (10 of 18 studies). Survival to discharge ranged from 49% to 96%. For ECMO, the most widely reported support modality, survival to discharge ranged from 54% to 72%. Many of these articles did not report adverse events. When reported, the rates of stroke, bleeding, and infection were consistently higher in all other MCS devices than in Impella. The rates of limb ischemia were comparable. Hemolysis rate was absent in these data except for one non-Impella study.

The review on the use of other MCS devices in PPCM yielded one prospective, multi-center study on patients who required VAD implant secondary to PPCM, using the INTERMACS registry. Survival to 1 month was 97%. Of note, only 66% of the patients described in the article above were in cardiogenic shock (INTERMACS 1 or 2) at the time of MCS device implant.

In conclusion, for available data on both Impella in these populations and other devices (pulsatile VADs and ECMO) the survival rates are comparable to the survival rates reported in the USpella and cVAD Study analyses (Figure 6.54). In addition for those articles where AEs were reported, the USpella registry shows lower rates of morbidities associated with Impella than ECMO and surgical VADs. This is attributed to the relative low profile of Impella as a percutaneous device in this setting.

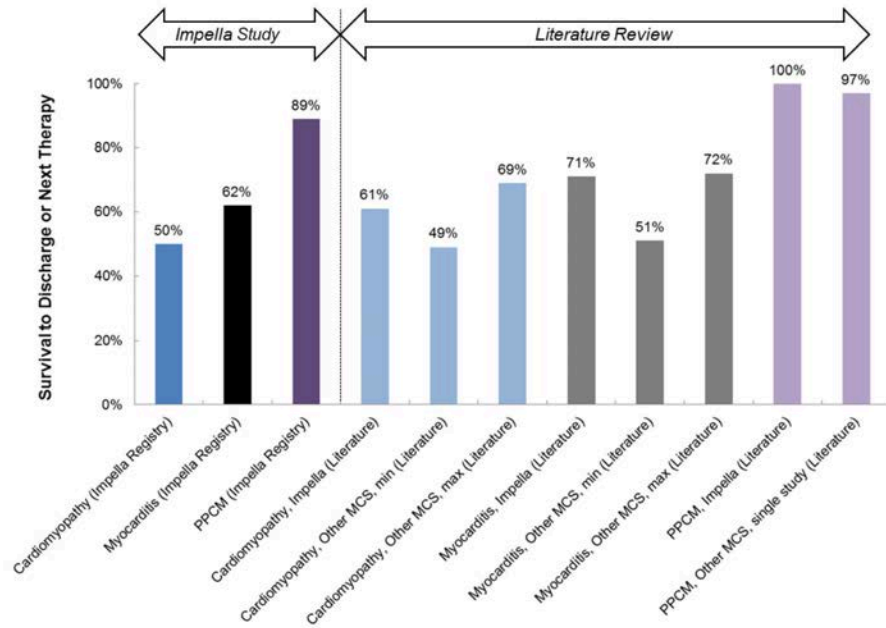

Figure 6.54 Survival Comparisons of Impella Registry Data, Impella Literature, and Other MCS Reviewed in Literature Review

CLINICAL EXPERIENCE FOR SYSTEMIC ANTICOAGULATION OF IMPELLA PATIENTS USING DIRECT THROMBIN INHIBITORS

Due to institutional protocol or physician assessment of individual patient risks, the clinical community today uses both heparin and direct thrombin inhibitors (DTIs) [specifically, bivalirudin and argatroban] to anticoagulate patients undergoing High Risk Percutaneous Coronary Interventions (PCI) with the Impella 2.5, Impella CP, and Impella CP with SmartAssist; and for patients in Cardiogenic Shock supported by the Impella 2.5, Impella CP, Impella CP with SmartAssist, Impella 5.0, and Impella LD Systems.

Clinical data collected from the Global cVAD Registry was analyzed for both high Risk PCI and Acute Myocardial Infarction with Cardiogenic Shock patients. Table 6.35 below provides site-reported adverse events (AEs) to discharge from the Global cVAD Registry analysis.

It should be noted that although there are some variances between the two groups, no statistical or clinical inference can be drawn presently due to relatively small sample sizes.

Physicians should assess individual patient risks while deciding on the anticoagulation protocol during Impella support.

Table 6.35 Site-reported AEs to Discharge from Global cVAD Registry Analysis

Adverse Event (AE)	High Risk PCI Patients		Acute Myocardial Infarction with Cardiogenic Shock Patients	
	DTI (N=50)	Heparin (N=300)	DTI (N=37)	Heparin (N=70)
Death	5.17%	3.00%	48.65%	35.71%
Myocardial Infarction	1.72%	0.33%	2.70%	1.43%
CVA / Stroke	0.00%	0.67%	10.81%	4.29%
Bleeding	1.72%	0.67%	13.51%	8.57%
Thrombocytopenia	1.72%	1.00%	13.51%	4.29%
Pulmonary embolism	0.00%	0.00%	0.00%	0.00%
Deep vein thrombosis	0.00%	0.33%	0.00%	0.00%

7 PATIENT MANAGEMENT TOPICS



PATIENT MANAGEMENT OVERVIEW	7.1
THE NEED FOR EARLY IDENTIFICATION OF CARDIOGENIC SHOCK PATIENTS	7.1
Literature Review:.....	7.2
GENERAL PATIENT CARE CONSIDERATIONS	7.3
TRANSPORT WITHIN THE HOSPITAL	7.3
RIGHT HEART FAILURE	7.4
ECG INTERFERENCE	7.4
LATEX	7.4
USE OF ECHOCARDIOGRAPHY FOR POSITIONING OF THE IMPELLA CATHETER	7.4
Background	7.4
Correct Impella Catheter Position	7.6
Impella Catheter Too Far into the Left Ventricle.....	7.6
Impella Catheter Inlet in the Aorta.....	7.6
Impella Catheter in Papillary Muscle	7.7
Color Doppler Echocardiography.....	7.10
Post-insertion Positioning (PIP) Checklist	7.11
UNDERSTANDING AND MANAGING IMPELLA CATHETER POSITION ALARMS	7.11
Correct Position.....	7.12
Impella 5.5 with SmartAssist Fully in Ventricle	7.12
Repositioning Guide for Impella 5.5 with SmartAssist	7.13
Using the Repositioning Guide	7.13
Impella Position in Aorta	7.16
Low Native Heart Pulsatility.....	7.16
Impella Catheter Outlet Area on or near Aortic Valve	7.17
IMPELLA STOPPED	7.18
SUCTION	7.18
Suction with the Impella 5.5 with SmartAssist Catheter	7.18
HEMOLYSIS	7.18
ENABLING PURGE FLOW NOTIFICATIONS	7.20
DISABLING AUDIO ALARMS	7.20
SURGICAL MODE	7.20
OPERATING THE IMPELLA CATHETER WITHOUT HEPARIN IN THE PURGE SOLUTION	7.21
TIMED DATA RECORDING	7.21
OPERATING THE IMPELLA CATHETER IN ELECTROMAGNETIC FIELDS	7.21
Electroanatomic Mapping (EAM) Systems	7.21
Magnetic Navigation Systems (MNS).....	7.22

Continued on next page



TRANSFERRING FROM THE AUTOMATED IMPELLA CONTROLLER TO A NEW AIC	7.23
Transfer Steps	7.23
Patient Management Checklist following Transfer of Support.....	7.24
EMERGENCY SHUTDOWN PROCEDURE	7.24
ANTI-COAGULATION THERAPY WITH IMPELLA HEPARIN INFUSION	7.25

PATIENT MANAGEMENT OVERVIEW

The information and instructions in this section of the manual are not intended to supersede established medical procedures concerning patient care. Best practice, as determined by the medical community, should always be observed. In each case, the clinician must determine whether the application of information provided is appropriate for the particular clinical setting.

THE NEED FOR EARLY IDENTIFICATION OF CARDIOGENIC SHOCK PATIENTS

Ineffective or detrimental treatments continue to result in poor outcomes. A key to making an impact on these outcomes is early identification and rapid intervention of cardiogenic shock. While the scientific definition of cardiogenic shock in trials generally involves hemodynamic assessment with right heart catheterization, the identifiers used in clinical practice are more universally adopted due to the inherent urgency of treatment. It is critical to raise awareness of the “downward spiral” accompanying cardiogenic shock.

In the medical literature, cardiogenic shock is defined by decreased cardiac output and evidence of tissue hypoxia in the presence of adequate intravascular volume. The decreased cardiac output leads to a persistent systemic hypotension with systolic blood pressure below 90 mmHg (or the requirement of vasopressors and/or inotropes to maintain a blood pressure above 90 mmHg) with reduction in cardiac index below 2.2 L/min/m² and normal or elevated filling pressure with a pulmonary capillary pressure above 15mmHg.¹

In the clinical setting (emergency room, ICU, CCU) when a right heart catheterization is not immediately available, cardiac and end-organ identifiers are used to recognize cardiogenic shock. Signs of end-organ hypoperfusion may be manifested clinically by SBP of <90 mmHg, altered sensorium, cool extremities, decreased urine output and elevated lactate level of >2 mmol/L. In practice, blood lactate levels have been shown to be a surrogate for tissue oxygenation and can be helpful in the identification of end-organ hypoperfusion in the setting of shock.²

Early shock identification and determining the etiology as cardiogenic are critical for initiation of appropriate therapy. Recognition of end-organ hypoperfusion in a patient with cardiac failure, through clinical assessment, laboratory testing (lactate, acidemia), and invasive testing with right heart catheterization enables diagnosis and tailored treatment planning.

LITERATURE REVIEW:

The Impella literature review encompasses a large body of scientific evidence from over 315 publications. The literature review provides further insight into the use of the Impella devices in routine clinical practice.

The literature analysis shows that cardiogenic shock patients, who were treated with emergent hemodynamic support, are, in general, older and present with high-risk comorbidities, poor functional status, and depressed cardiac function. Overall, the survival rates and morbidities also appear to be favorable for use of the Impella devices as compared with the surgical VAD. This comprehensive set of data that was collected over the course of more than 12 years, from real-world registry results, clinical trials, and published literature on the Impella 2.5, Impella CP, and Impella 5.0, were presented to the U.S. FDA and resulted in the FDA's designation that Impella is safe and effective in the post-surgery and post-AMI cardiogenic shock setting.

Update indication: The Impella 2.5[®], Impella CP[®], Impella CP[®] with SmartAssist[®], Impella 5.0[®] and Impella LD[®] Catheters, in conjunction with the Automated Impella Controller (collectively, "Impella[®] System Therapy"), are temporary ventricular support devices intended for short term use (≤ 4 days for the Impella 2.5, Impella CP, and the Impella CP with SmartAssist, and ≤ 14 days for the Impella 5.0, and Impella LD) and indicated for the treatment of ongoing cardiogenic shock that occurs immediately (< 48 hours) following acute myocardial infarction or open heart surgery or in the setting of cardiomyopathy, including peripartum cardiomyopathy, or myocarditis as a result of isolated left ventricular failure that is not responsive to optimal medical management and conventional treatment measures (including volume loading and use of pressors and inotropes, with or without IABP). The intent of Impella System Therapy is to reduce ventricular work and to provide the circulatory support necessary to allow heart recovery and early assessment of residual myocardial function.

Table 7.1 : Clinical Society Guidelines for Impella Therapy

Clinical Society Guideline Populations (SCAI, ACCF, HFSA, STS, ISHLT, HRS)	Class	Latest Update	Impella FDA Approval
PCI in Cardiogenic Shock	I	2013	2016
Multi-organ Failure, Cardiogenic Shock	I	2013	2016
PCI in Low Ejection Fraction, Complex CAD	IIb	2011*	2015
Bridge to Recovery or Decision, Cardiogenic Shock	IIa	2013	2016
STEMI and Cardiogenic Shock	IIb	2013	2016
STEMI and Urgent CABG	IIa	2013	2016
Acutely Decompensated Heart Failure	IIa	2012	TBD
Consensus Document on Hemodynamic Support	N/A	2015	2015-2016

1. Hochman JS, Sleeper LA, Webb JG, et al. Early revascularization in acute myocardial infarction complicated by cardiogenic shock. SHOCK Investigators. Should We Emergently Revascularize Occluded Coronaries for Cardiogenic Shock. *N Engl J Med.* 1999;341(9):625-634.

2. Fuller BM, Dellinger RP. Lactate as a hemodynamic marker in the critically ill. *Curr Opin Crit Care.* 2012;18(3):267-272.

** Categories referencing Impella include Percutaneous LVAD, PVAD, Non-durable MCS, TCS and percutaneous MCSD

* Excludes Protect II Randomized Controlled Trial, and FDA PMA approval studies due to timing of available data in 2011

GENERAL PATIENT CARE CONSIDERATIONS

- Access site management should be done in accordance with hospital protocol, using aseptic technique.
- Assess access site for bleeding and hematoma.
- Monitor pedal pulses.
- To prevent the purge tubing from kinking, do not allow the red Impella plug to hang freely from the catheter and do not bend the catheter near the red Impella plug.
- Consider attaching the red Impella plug and catheter to a short armboard to prevent the catheter from kinking near the plug.
- When transferring a patient with the device in place:
 - Be careful not to pull on the Impella Catheter when transferring a patient from one bed to another.
 - Do not raise the head of the bed to higher than a 30-degree angle.
 - Use care when moving or turning a patient; the Impella Catheter may move out of position and cause a positioning alarm.
 - ACT 160-180 seconds

TRANSPORT WITHIN THE HOSPITAL

Patients supported with the Impella Catheter may require transfer from the OR or cath lab into the ICU setting with the device in place. Considerations for transport within the hospital include the following:

- The Automated Impella Controller and Impella Catheter are designed to operate on battery power for at least 1 hour.
- Confirm that the battery capacity displayed on the controller is 100%.
- If transport time might be longer than 1 hour, bring an extension cord or confirm that you will be able to connect the controller to AC power once you arrive at your destination.
- When rolling the Automated Impella Controller cart across a threshold, firmly grasp the cart handle and pull it over the threshold.
- Pay close attention to all system components and connections when rolling the Automated Impella Controller cart over thresholds and through elevator doors.
- Do not stress the connector cable from the controller to the Impella Catheter.

RIGHT HEART FAILURE

Caregivers should monitor patients being supported by the Impella Catheter for signs of right heart failure:

- Reduced output from the Impella Catheter
- Suction alarms
- Elevated filling pressures (CVP)
- Signs of liver failure
- Elevated pulmonary pressures

If the patient is exhibiting signs of right heart failure, the clinical team should assess the need for a more durable form of support.

ECG INTERFERENCE

Operating the Automated Impella Controller may cause interference with electrocardiogram (ECG) signals. Please check the electrode pads and leads for good fixation and contact. If interference persists, activate the 50/100 Hz band-elimination filter or the 60/120 Hz band-elimination filter (also known as notch filter) on your ECG device. The filter frequency will be based on the AC power frequency for the country in which you are operating the equipment.

If your ECG device does not have the appropriate filters, disconnect the Automated Impella Controller temporarily from AC power to obtain an undisturbed signal. Please observe the battery status while running the Automated Impella Controller on battery power.

LATEX

The Automated Impella Controller and Impella Catheters, including all accessories, are not made with natural rubber latex.

USE OF ECHOCARDIOGRAPHY FOR POSITIONING OF THE IMPELLA CATHETER

BACKGROUND

Echocardiography is a commonly used tool for evaluating the position of the Impella Catheter relative to the aortic valve and other intraventricular structures post-placement. The best echocardiographic views for positioning the Impella Catheter in the left ventricle are a long axis transesophageal echocardiogram (TEE) or a parasternal long axis transthoracic echocardiogram (TTE). These long axis views allow you to see both the aortic valve and Impella Catheter inlet area.

Evaluate the position of the Impella Catheter if the Automated Impella Controller displays position alarms or if you observe lower than expected flows or signs of hemolysis. If the catheter does not appear to be correctly positioned, initiate steps to reposition it.

The illustrations on the following page identify the structures you would expect to see in transesophageal echocardiography (top) and transthoracic echocardiography (bottom). In these illustrations, the Impella Catheter is positioned correctly; however, these depictions are stylized and in actual echocardiograms inlet and outlet areas may not be seen as distinctly. The graphics in this section depict the Impella 5.5 with SmartAssist Catheter.

Transesophageal Echocardiogram (TEE) of Impella Catheter

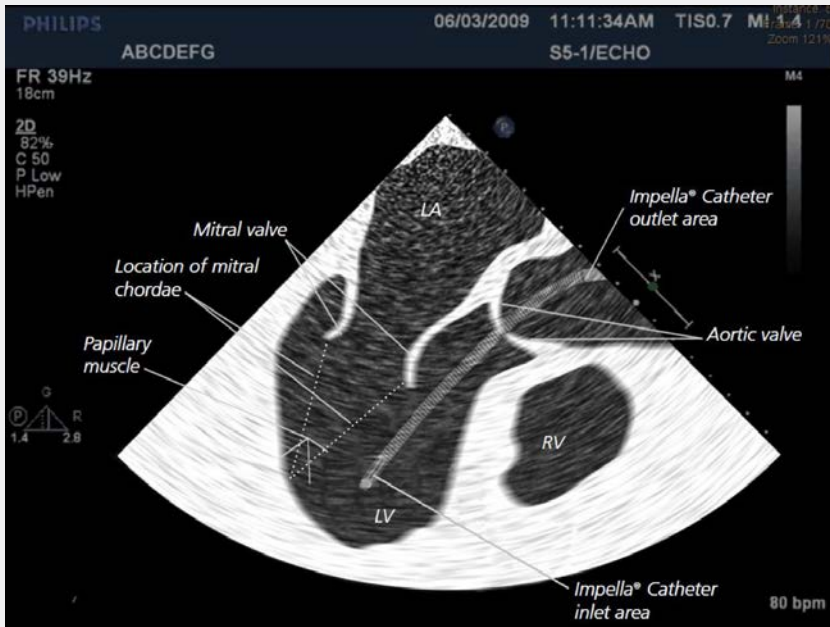

Transthoracic Echocardiogram (TTE) of Impella Catheter

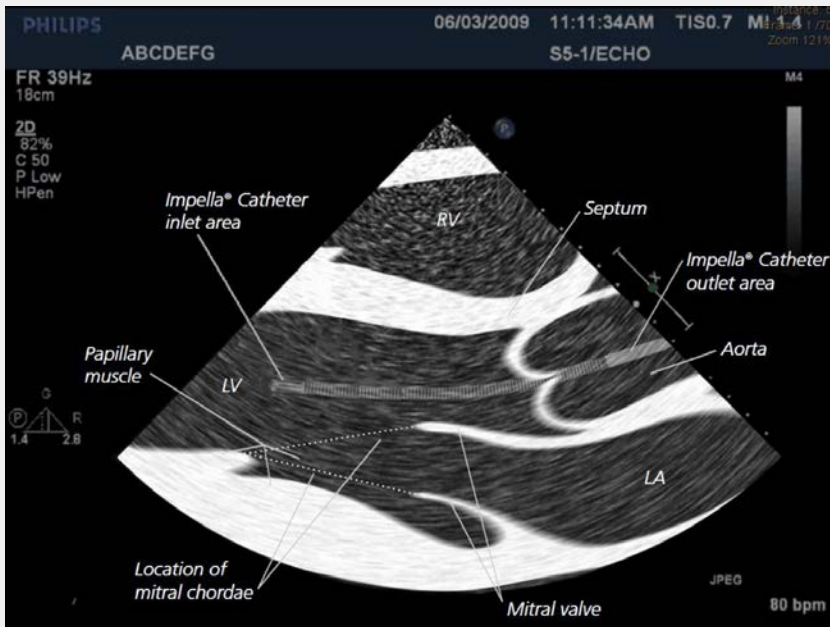

Figure 7.1 Labeled TEE and TTE Images of the Impella Catheter Position

Four Impella Catheter positions you are likely to encounter when examining echocardiograms from patients supported with the Impella Catheter include:

- Correct Impella Catheter position
- Impella Catheter too far into the left ventricle
- Impella Catheter inlet in the aorta
- Impella Catheter in papillary muscle

The following pages describe each situation. Figure 7.2 illustrates a transesophageal echocardiogram (TEE) of each situation. Figure 7.3 illustrates a transthoracic echocardiogram (TTE) of each.

CORRECT IMPELLA CATHETER POSITION

For optimal positioning of the Impella Catheter, the cannula bend should be at the aortic valve annulus, placing inlet approximately 5 cm deep into ventricle and well away from papillary muscle and subannular structures. If the Impella Catheter is not inserted so that the cannula bend is at the aortic valve annulus it may become dislodged from the ventricle. The outlet area should be well above the aortic valve. If the Impella Catheter is correctly positioned, echocardiography will likely show the following, as depicted in Figures 7.2a (TEE) and 7.3a (TTE):

- The cannula bend should be at the aortic valve annulus, placing inlet approximately 5 cm deep into ventricle.
- Catheter outlet area well above the aortic valve (frequently not visible on TEE or TTE images)
- Catheter angled toward the left ventricular apex away from the heart wall and not curled up or blocking the mitral valve

IMPELLA CATHETER TOO FAR INTO THE LEFT VENTRICLE

If the Impella Catheter is positioned too far into the left ventricle, the patient will not receive the benefit of Impella Catheter support. Blood will enter the inlet area and exit the outlet area within the ventricle. Obstruction of the Impella Catheter inlet area can lead to increased mechanical forces on blood cell walls and subsequent hemolysis, which often presents as dark or blood-colored urine. If the Impella Catheter is too far into the left ventricle, echocardiography will likely show the following, as depicted in Figures 7.2b (TEE) and 7.3b (TTE):

- Cannula bend inserted passed the aortic valve annulus
- Catheter outlet area across or near the aortic valve

IMPELLA CATHETER INLET IN THE AORTA

If the inlet area of the Impella Catheter is in the aorta, the patient will not receive the benefit of Impella Catheter support. The catheter will pull blood from the aorta rather than the left ventricle. In addition, suction is possible if the inlet area is against the wall of the aorta or valve sinus. If the inlet area of the Impella Catheter is in the aorta, echocardiography will likely show the following, as depicted in Figures 7.2c (TEE) and 7.3c (TTE):

- Catheter inlet area in aorta or near the aortic valve

IMPELLA CATHETER IN PAPILLARY MUSCLE

If the inlet area of the Impella Catheter is too close to or entangled in the papillary muscle and/or subannular structures surrounding the mitral valve, it can affect mitral valve function and negatively impact catheter flow. If the inlet area of the catheter is lodged adjacent to the papillary muscle, the inflow may be obstructed, resulting in suction alarms. This positioning is also likely to place the outlet area too close to the aortic valve, which can cause outflow at the level of the aortic valve with blood streaming back into the ventricle, resulting in turbulent flow and hemolysis. If the Impella Catheter is too close to or entangled in the papillary muscle, echocardiography will likely show the following, as depicted in Figures 7.2d (TEE) and 7.3d (TTE):

- Catheter inlet in papillary muscle
- Cannula bend inserted passed the aortic valve annulus or lodged between papillary muscle and the myocardial wall
- Catheter outlet area too close to the aortic valve

The following figures depict transesophageal and transthoracic echocardiographic images of these four Impella Catheter positions. Figure 7.2 shows four transesophageal depictions of Impella Catheter position and Figure 7.3 shows four transthoracic depictions of Impella Catheter position.



a. Correct Impella Catheter Position (TEE)

- Cannula bend should be at the aortic valve annulus, placing inlet approximately 5 cm deep into ventricle.
- Catheter outlet area well above the aortic valve
- Catheter angled toward the left ventricular apex away from the heart wall and not curled up or blocking the mitral valve



b. Impella Catheter Too Far into Left Ventricle (TEE)

- Cannula bend inserted passed the aortic valve annulus
- Catheter outlet area across or near the aortic valve



c. Impella Catheter Inlet in Aorta (TEE)

- Catheter inlet area in aorta or near the aortic valve



d. Impella Catheter in Papillary Muscle (TEE)

- Catheter inlet in papillary muscle
- Cannula bend inserted passed the aortic valve annulus or lodged between papillary muscle and the myocardial wall
- Catheter outlet area too close to the aortic valve

Figure 7.2 Transesophageal Echocardiographic (TEE) Illustrations of Impella Catheter Position

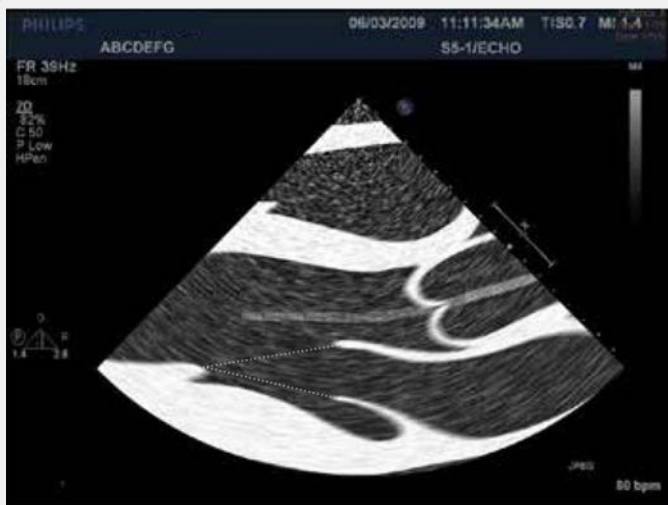

a. Correct Impella Catheter Position (TTE)

- Cannula bend should be at the aortic valve annulus, placing inlet approximately 5 cm deep into ventricle.
- Catheter outlet area well above the aortic valve
- Catheter angled toward the left ventricular apex away from the heart wall and not curled up or blocking the mitral valve

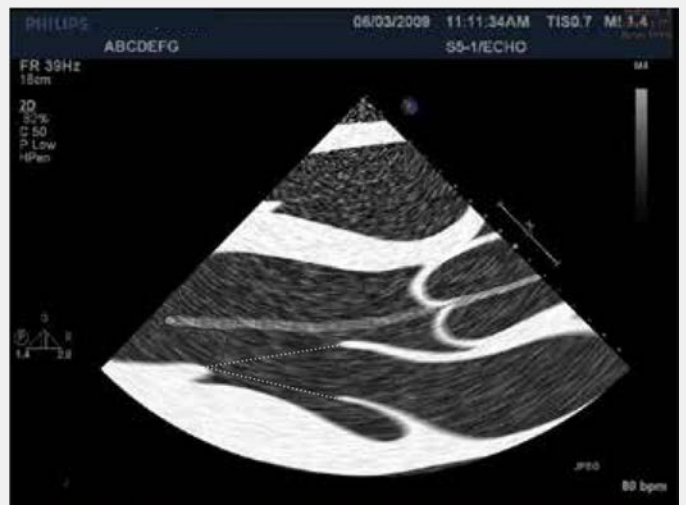

b. Impella Catheter Too Far into Left Ventricle (TTE)

- Cannula bend inserted passed the aortic valve annulus
- Catheter outlet area across or near the aortic valve

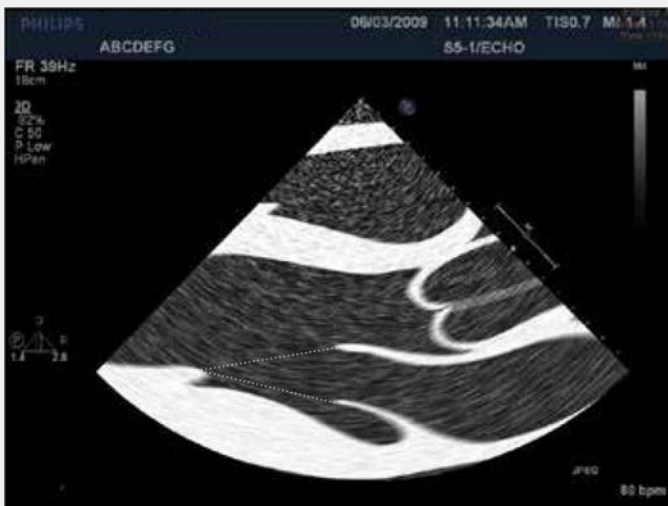

c. Impella Catheter Inlet in Aorta (TTE)

- Catheter inlet area in aorta or near the aortic valve

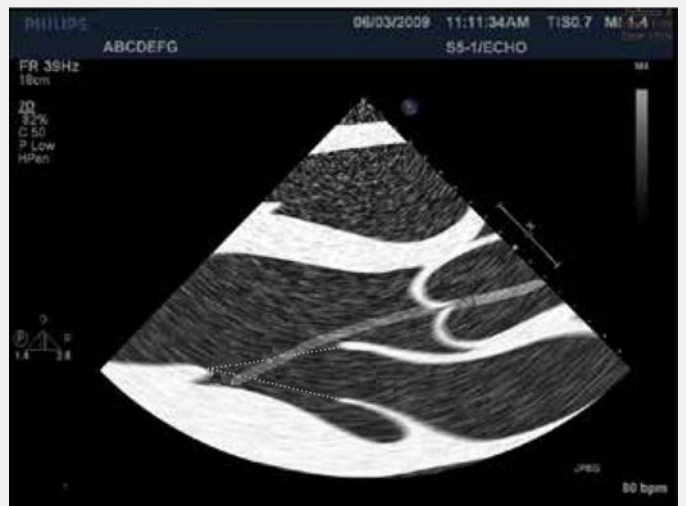

d. Impella Catheter in Papillary Muscle (TTE)

- Catheter inlet in papillary muscle
- Cannula bend inserted passed the aortic valve annulus or lodged between papillary muscle and the myocardial wall
- Catheter outlet area too close to the aortic valve

Figure 7.3 Transthoracic Echocardiographic (TTE) Illustrations of Impella Catheter Position

COLOR DOPPLER ECHOCARDIOGRAPHY

When moving a patient supported with an Impella Catheter, it is important to monitor catheter migration. Adding color Doppler to an echo is another way to verify catheter position. If the Impella Catheter is correctly positioned, a dense mosaic pattern of turbulence will appear *above* the aortic valve near the outlet area of the catheter, as shown in the top image in Figure 7.4. If, however, the echocardiogram reveals a dense mosaic pattern of turbulence *beneath* the aortic valve (bottom image in Figure 7.4), this likely indicates that the outlet area of the catheter is in the wrong position, that is, the catheter is too far into the ventricle or entangled in papillary muscle. (Note: If using transesophageal echocardiography [TEE], look for the mosaic patterns in the same locations relative to the aortic valve and Impella Catheter outlet area.)

Correct Impella Catheter Position (Color Doppler TTE)

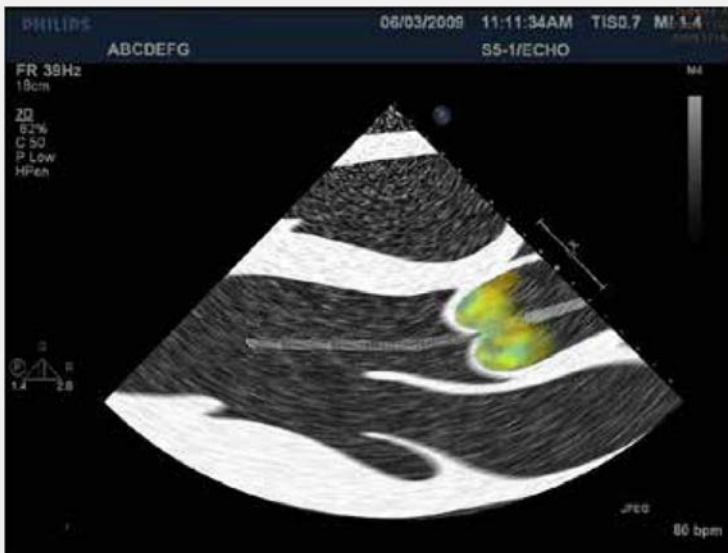

Incorrect Impella Catheter Position (Color Doppler TTE)

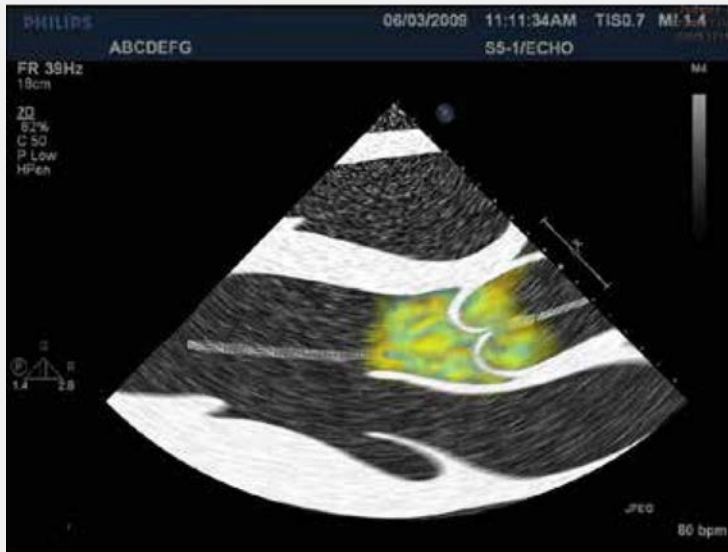

Figure 7.4 Correct and Incorrect Impella Catheter Position (Color Doppler TTE)

POST-INSERTION POSITIONING (PIP) CHECKLIST

Completing the steps shown in the following post-insertion positioning checklist can help to ensure proper position of the Impella 5.5 with SmartAssist Catheter following insertion. Pay particular attention to positioning after the patient is moved from the operating room or catheterization laboratory.

1. Remove slack in the Impella Catheter by increasing P-level to P-9 and align the catheter against the lesser curvature of the aorta (rather than the greater curvature).
2. Use echo to verify that the slack has been removed.
3. Verify that the Impella Catheter inlet area is optimally positioned 5.0 cm below the aortic valve.
4. Return to previous P-level.
5. Secure the Impella Catheter at a firm external fixation point on the chest.

UNDERSTANDING AND MANAGING IMPELLA CATHETER POSITION ALARMS

The Automated Impella Controller continuously monitors the catheter based on the placement signal and the motor current.

- Placement signal: *Is the signal characteristic of aortic or ventricular pressure?*
- Motor current: *Is the signal “pulsatile” or “flattened”?*

If the system alarms with one of the positioning alarms described in this section, echocardiography imaging is the best method for confirming position. You can also use TEE, TTE, or fluoroscopy.

If the Impella Catheter is either partly or completely in the ventricle, reposition the catheter under imaging guidance. If imaging guidance is not available and the Impella Catheter is completely in the ventricle, the pump may be repositioned using waveforms displayed on the Automated Impella Controller. Refer to section 7.14 for more information.

If the Impella Catheter is completely out of the ventricle, do not attempt to reposition the catheter across the valve without a guidewire.

The following pages describe possible placement conditions and the associated signal characteristics and alarm messages as well as actions to take for each.

CORRECT POSITION

If the Impella Catheter is in the correct position, the placement screen will appear as shown in Figure 7.5 for the Impella 5.5 with SmartAssist.

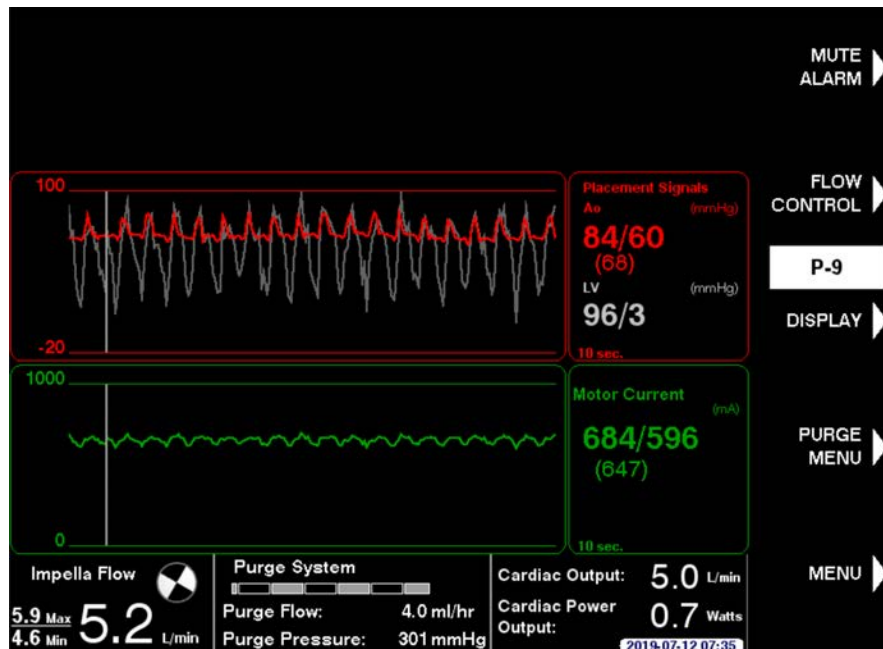

Figure 7.5 Correct Impella 5.5 Catheter Position

IMPELLA 5.5 WITH SMARTASSIST FULLY IN VENTRICLE

If the Impella 5.5 with SmartAssist Catheter is fully in the ventricle, the following alarm will appear:

Impella Position in Ventricle

In this situation, the placement screen will appear as shown in Figure 7.6 below.

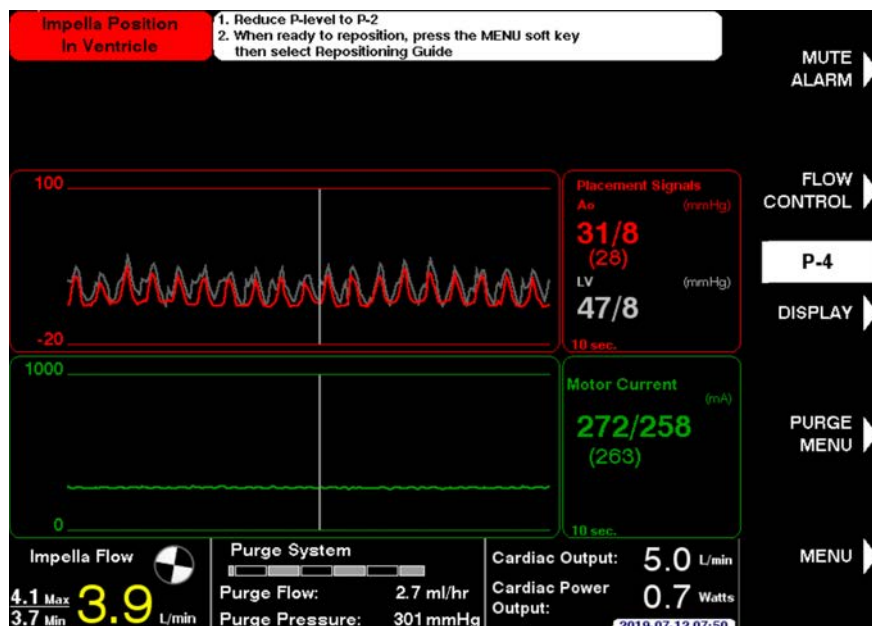

Figure 7.6 Impella 5.5 with SmartAssist Catheter Position in Ventricle

Actions to take:

1. Under fluoroscopic or echocardiographic guidance, reduce the P-level to P-2 and carefully pull back the Impella Catheter until the aortic waveform signal is showing.
2. When you see the aortic waveform signal, pull the catheter back an additional 3 cm

REPOSITIONING GUIDE FOR IMPELLA 5.5 WITH SMARTASSIST

If fluoroscopy or other imaging guidance is not available and you receive an “Impella Position In Ventricle” alarm, you can use the repositioning guide to correct the position of the catheter across the aortic valve. The repositioning guide provides information about the current position of the catheter and the actions required to reposition it.

USING THE REPOSITIONING GUIDE

1. Reduce P-level to P-2.
2. Press the **MENU** soft button and select Repositioning Guide using the selector knob.
3. Press the **START** soft button to initiate the repositioning guide.
4. Loosen the Touhy-Borst valve to unlock the Impella catheter prior to repositioning. Press the **DONE** soft button to continue.

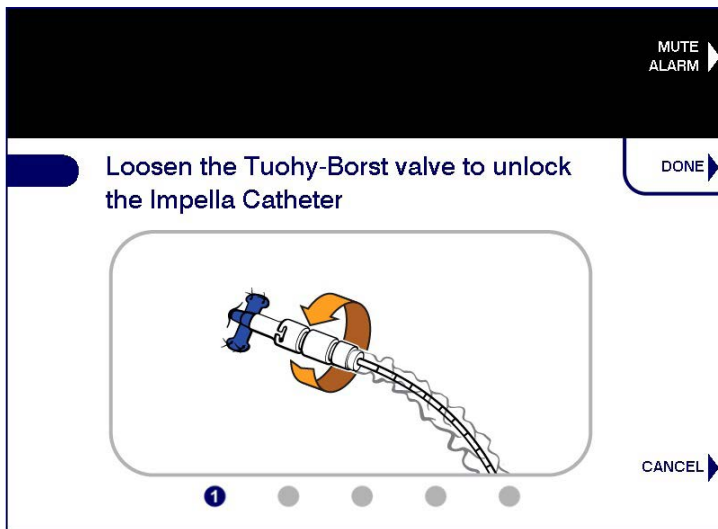

Figure 7.7 Loosen the Tuohy-borst Valve

5. Pull the Impella Catheter slowly—1cm at a time—while monitoring for an aortic placement signal waveform on the Automated Impella Controller screen. When the placement signal shifts to aortic, stop pulling the Impella Catheter. Press the **DONE** soft button to continue.

Impella Position in Aorta

If the Impella catheter is pulled all the way into the aorta while in the repositioning guide, an error screen will be shown. Follow the prompts on the error screen and repositioning with appropriate imaging techniques.

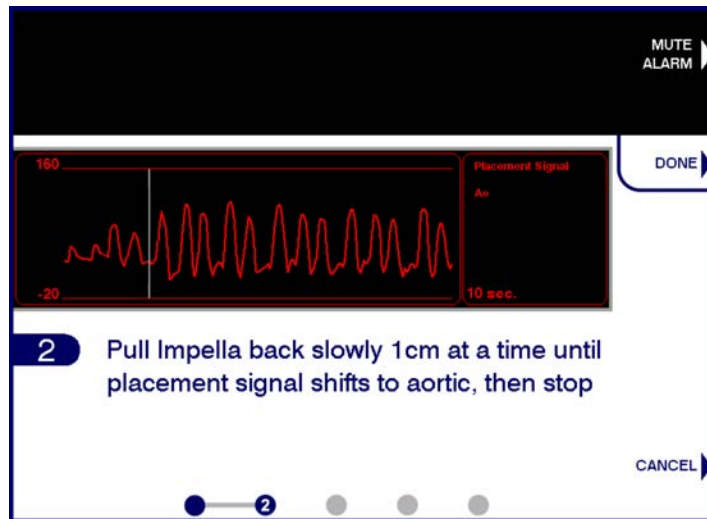

Figure 7.8 Pulling Catheter Back Until Waveform Shifts to Aortic

6. Using the centimeter markings on the catheter, pull the Impella back slowly and additional 3 centimeters. Press the **DONE** soft button to continue.

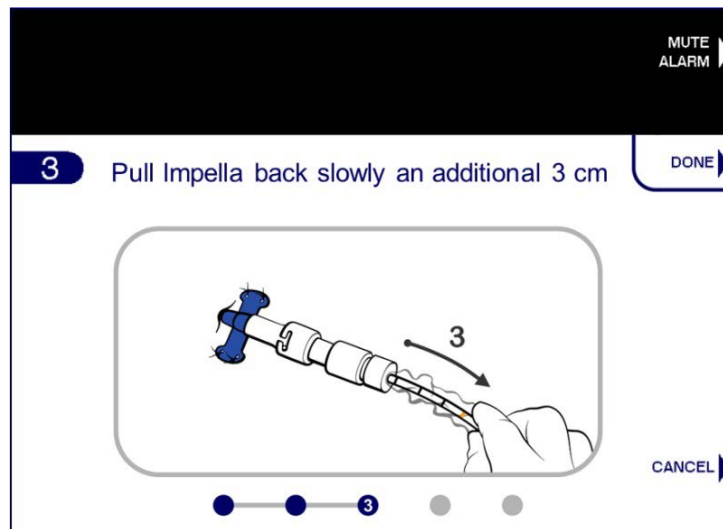

Figure 7.9 Pulling Catheter Additional 3 cm

7. Tighten to Tuohy – Borst valve to lock the Impella catheter in place. Press the **DONE** soft button to continue.

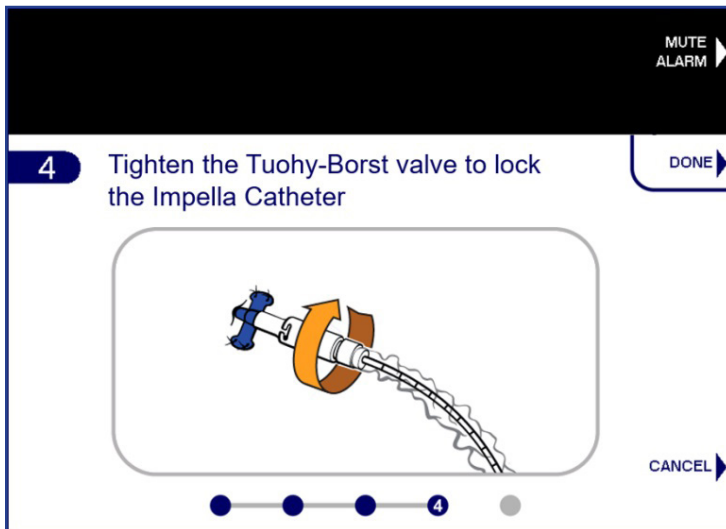

Figure 7.10 Tightening Tuohy-borst Valve

8. Press the **DONE** soft button to exit the repositioning guide. Ramp up slowly to the preferred P-level after exiting the guide.

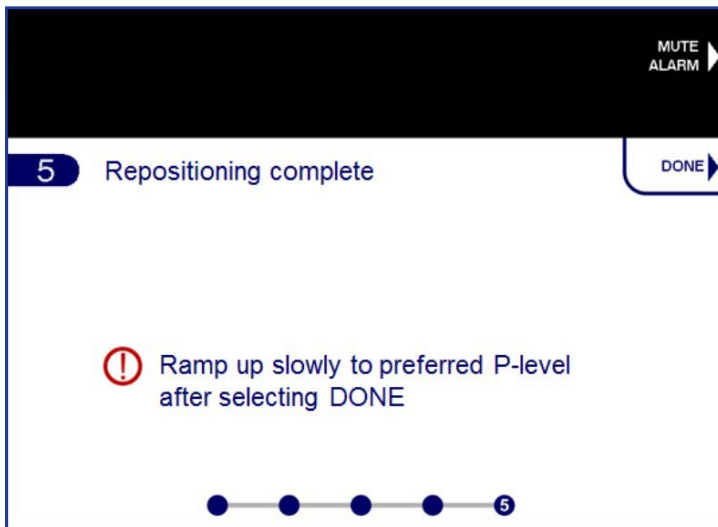

Figure 7.11 Repositioning Complete

IMPELLA POSITION IN AORTA

In this situation, the home screen will appear as shown in Figure 7.12 below.

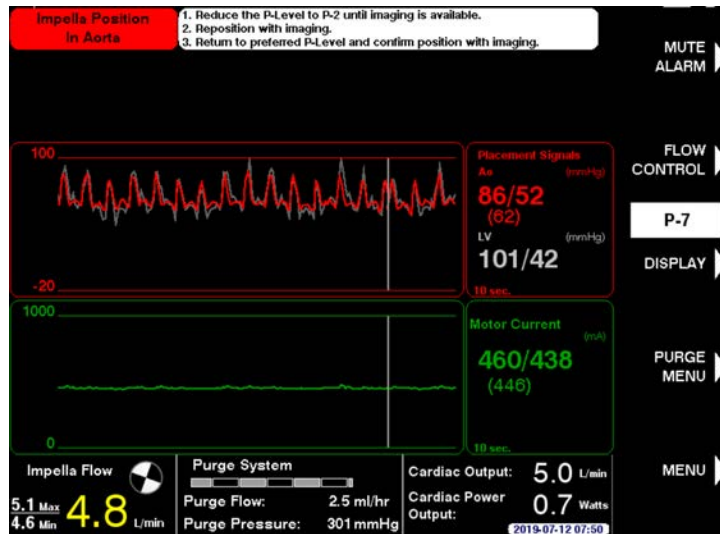

Figure 7.12 Impella 5.5 with SmartAssist Position in Aorta

Actions to take:

1. Reduce the P-level to P-2 until imaging is available.
2. Under fluoroscopic or echocardiographic guidance, determine the Impella Catheter position.
3. Return to preferred P-level and confirm positioning with imaging.

LOW NATIVE HEART PULSATILITY

When a patient has poor native ventricular function, the placement signal may remain pulsatile; however, the amplitude will be dampened and both the minimum and maximum values will be greater than zero because the aortic valve does not open and the Impella 5.5 with SmartAssist Catheter raises the aortic blood pressure above the ventricular pressure during systole.

In a situation of low native heart pulsatility, the Automated Impella Controller may not be able to determine the catheter position. You may see the following indication on the home screen:

Impella Position Unknown

In this situation, the screen will appear as shown in Figure 7.13. Notice that the flow rate is displayed in yellow in the lower-left corner of the screen, indicating that the patient may not be getting the benefit of the displayed flow rate.

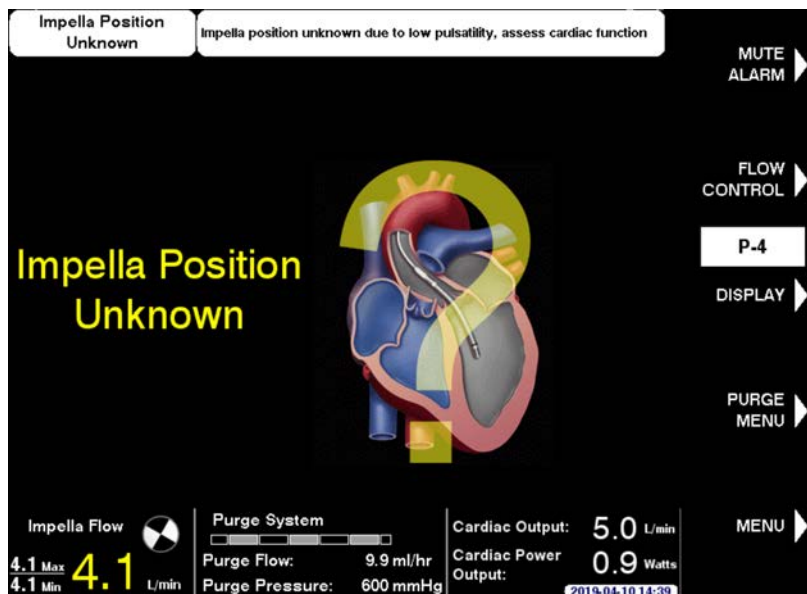

Figure 7.13 Impella 5.5 with SmartAssist Catheter Position Unknown

Actions to take:

1. Assess cardiac function.
2. If needed, confirm catheter position with echocardiography.

IMPELLA CATHETER OUTLET AREA ON OR NEAR AORTIC VALVE

If the Impella® Catheter outlet area is on or near the aortic valve, the catheter may be too deep in the ventricle.

In this situation, the Automated Impella Controller may not be able to determine the catheter position. You may see the following indication on the home screen:

Placement Signal Low.

Actions to take:

1. Assess cardiac function.
2. If patient's diastolic pressures are greater than 30 mmHg, confirm Impella position with imaging and reposition as needed.

IMPELLA STOPPED

If the Impella Catheter has stopped suddenly:

1. Try to restart the catheter at previous P-level.
2. If the Impella does not restart, try to restart at P-2.
3. If the Impella does not restart or stops again, wait 1 minute and try to restart again.
4. If the Impella restarts, wean down to P-2 as the patient can tolerate. Under these circumstances, catheter function is not reliable and the Impella may stop again.
5. If the Impella does not restart, remove the Impella from the ventricle as soon as possible to avoid aortic insufficiency.

SUCTION

Suction may occur if the blood volume available for the Impella Catheter is inadequate or restricted. Suction limits the amount of support that the Impella Catheter can provide to the patient and results in a decrease in arterial pressure and cardiac output. It can damage blood cells, leading to hemolysis. It may also be an indicator of right heart failure.

SUCTION WITH THE IMPELLA 5.5 WITH SMARTASSIST CATHETER

If the “Suction” alarm occurs during support with the Impella 5.5 with SmartAssist Catheter, follow the recommended actions:

1. Reduce P-level by 1 or 2 levels to reduce the effects of suction.
2. Assess patient's fluid intake and output to confirm adequate volume status.
3. Check the Impella Catheter for correct positioning using imaging. Reposition the catheter by rotating or moving it into or out of the ventricle slightly. Either or both of these actions could help move the inlet of the Impella Catheter away from the interior ventricular wall.
4. Confirm right ventricular function by assessing CVP or right side function with echocardiography. If CVP is not an option, check the pulmonary artery diastolic pressure to assess the patient volume status.
5. Return the P-level to pre-alarm setting.

HEMOLYSIS

When blood is pumped, it is subjected to mechanical forces. Depending on the strength of the blood cells and the amount of force applied, the cells may be damaged, allowing hemoglobin to enter the plasma. Pumping forces can be generated by a variety of medical procedures including heart lung bypass, hemodialysis, or ventricular assist device (VAD) support. Patient conditions—including catheter position, pre-existing medical conditions, and small left ventricular volumes—may also play a role in patient susceptibility to hemolysis.

Hemolysis should be monitored during support. Patients who develop high levels of hemolysis may show signs of decreased hemoglobin levels, dark or blood-colored urine, and in some cases, acute renal failure. Plasma-free hemoglobin (PfHgb) is the best indicator to confirm whether a patient is exposed to an unacceptable level of hemolysis.

Management technique may differ depending on the underlying cause of hemolysis. Table 7.1 provides guidance for various circumstances.

Table 7.2 Guide for Managing Hemolysis in Various Circumstances

Condition	Controller Indicators	Clinical Indicators	Management
Impella inlet area in close proximity to intraventricular wall	<ul style="list-style-type: none"> • “Suction” alarms • Lower than expected flows 	Imaging (see note)	<ul style="list-style-type: none"> • Reposition the catheter by rotating or moving the catheter into or out of the ventricle slightly. Either or both of these actions could help move the inlet of the catheter away from the intraventricular wall. • If repositioning will be delayed, reduce the P-level if tolerated by patient hemodynamics. Return to the previous P-level after repositioning. • Reassess position after flow rate has returned to desired target value.
Wrong pump position	<ul style="list-style-type: none"> • Position alarms with higher than expected flows • “Impella Flow Reduced” or “Suction” alarms with lower than expected flows • Pump outlet blocked alarms 	Imaging (see note)	<ul style="list-style-type: none"> • Reposition the catheter by rotating or moving the catheter into or out of the ventricle slightly. Either or both of these actions could help move the inlet of the catheter away from the intraventricular wall. • If repositioning will be delayed, reduce the P-level to P-2. Return to the previous P-level after repositioning. • Reassess position after flow rate has returned to desired target value.
Higher than needed P-Level setting	<ul style="list-style-type: none"> • There may be no controller indicators • “Impella Flow Reduced” or “Suction” alarms 	<ul style="list-style-type: none"> • Normal hemodynamics • Native recovery 	<ul style="list-style-type: none"> • Reduce P-level until patient pressure starts to drop. • Slowly increase P-level.
Inadequate filling volume	<ul style="list-style-type: none"> • Position alarms • “Impella Flow Reduced” or “Suction” alarms • Lower than expected flows 	<ul style="list-style-type: none"> • Low CVP • Low PCWP • Low AOP • High PA pressures • Right heart failure • High urine output • Increased bleeding or chest tube drainage 	<ul style="list-style-type: none"> • Reduce the P-level if tolerated by patient hemodynamics. • Correct I and O balance. • Consider giving volume; additional volume will expand the end systolic ventricular volume. • Reduce PA pressure. • Improve right heart function.
Pre-existing patient conditions or other medical procedures	N/A	<ul style="list-style-type: none"> • Patient past medical history • Current procedures or treatments 	

Note on imaging: All imaging technology represents the anatomy in two dimensions (2D). It is not possible to assess the interactions between the catheter and the intraventricular anatomy that occur in three dimensions (3D). Abiomed strongly recommends that the catheter be repositioned, even if the imaging view shows correct position.

ENABLING PURGE FLOW NOTIFICATIONS

The purge flow notification white alarms (“Purge Flow Increased” and “Purge Flow Decreased”) are disabled by default.

To enable these alarms:

1. Press **MENU** and scroll to “Settings/Services.” Press the selector knob.
2. Scroll to “Enable Purge Flow Change Notifications” and press the selector knob to enable these alarms.

DISABLING AUDIO ALARMS

The audio for the following alarms can be disabled:

- Placement Signal Not Reliable
- Placement Signal Low
- Suction
- Purge System Blocked

To disable the audio:

1. Press **MENU** and scroll to “Settings/Services.” Press the selector knob.
2. Highlight alarm and press the selector knob to disable the audio for this alarm.

SURGICAL MODE

Surgical Mode can be enabled to silence the “Impella Stopped” alarm that occurs when P-level is reduced to P-0. A white banner notification appears throughout the duration of Surgical Mode support.

To enable Surgical Mode:

1. Press **MENU** and scroll to “Settings/Services.” Press the selector knob.
2. Scroll to “Enable Surgical Mode” and press the selector knob to enable it.

You can disable Surgical Mode in one of two ways:

1. Increase P-level above P-0, or
2. Press **MENU** and scroll to and select “Settings/Services” and then scroll to and select “Disable Surgical Mode.”

OPERATING THE IMPELLA CATHETER WITHOUT HEPARIN IN THE PURGE SOLUTION

The Impella Catheter is designed to be operated with a purge solution that contains heparin. Operation of the system without heparin in the purge solution has not been tested. In the event that a patient is intolerant to heparin, due to heparin-induced thrombocytopenia (HIT) or bleeding, physicians should use their clinical judgment to assess the risks versus benefits of operating the Impella System without heparin.

If it is in the best interest of the patient to operate the system without heparin, the dextrose solution is still required, and physicians should consider *systemic delivery* of an alternative anticoagulant. The Impella Catheter has not been tested with any alternative anticoagulants in the purge solution. Use of alternative anticoagulants may reduce the longevity or performance of the Impella catheter.

TIMED DATA RECORDING

The Automated Impella Controller can hold up to 24 hours of real-time data. Once memory is full, the controller starts overwriting the old data. The timed data recording feature allows you to permanently save real-time operating data for later analysis. Timed data recording is automatically turned on during certain alarm conditions to capture data for analysis. You can also manually turn on the feature at any time to capture data for later analysis.

To manually access the timed data recording feature:

1. Press **MENU** and scroll to "Start Data Snapshot." Press the selector knob.
2. The controller records data for a predefined period of 10 minutes.

OPERATING THE IMPELLA CATHETER IN ELECTROMAGNETIC FIELDS

The Impella Catheter contains a permanent magnet motor that emits an electromagnetic field. This field may produce electromagnetic interference with other equipment. In addition, other equipment that emits a strong electromagnetic field may affect the operation of the Impella Catheter motor.

ELECTROANATOMIC MAPPING (EAM) SYSTEMS

The electromagnetic field emitted by the Impella Catheter may produce interference with the magnetic location detection component of the electroanatomic mapping (EAM) system, particularly when the mapping catheter is close to the Impella Catheter motor. For example, mapping in the right or left ventricular outflow tracts places the mapping catheter in close proximity to the Impella Catheter motor in the ascending aorta.

Electromagnetic interference may appear as:

- Instability in the displayed location of the mapping catheter
- Magnetic interference errors generated by the electroanatomic mapping system

When operating the Impella Catheter in the presence of an EAM system, use P-level mode.

Examples of EAM Systems

CARTO® 3 System and CARTO® XP Navigation System (Biosense Webster, Inc.)

Operate the Impella Catheter at P-1–P-5 or P-7. The motor speeds at these P-levels cause the least interference. Best performance is observed when the Impella Catheter motor is at least 3 cm from the sensors in the mapping catheter. If you suspect interference, follow the troubleshooting steps in Table 7.3.

Table 7.3 Troubleshooting When Operating the Impella Catheter in the Presence of an EAM System

Observation	Actions
Interference with the magnetic location detection component of the EAM system	<ol style="list-style-type: none"> 1. Check for and address other sources of interference. 2. Reposition the Impella Catheter to ensure that the Impella motor is at least 3 cm from the sensors in the mapping catheter; however do NOT pull the inlet area out of the left ventricle. 3. Ensure that the Impella Catheter is operating at P-1–P-5 or P-7, as these P-levels cause the least interference.

Example of MNS

*Stereotaxis Niobe®
Magnetic Navigation System
(Stereotaxis)*

MAGNETIC NAVIGATION SYSTEMS (MNS)

When initiating Impella Catheter support in the presence of a magnetic navigation system (MNS), follow the steps below:

1. Insert the Impella Catheter following the steps outlined in section 5 of this manual.
2. Place the MNS magnets in the “Reduced” or “Stowed” position.
3. Start the Impella Catheter in the manner described in section 5 of this manual. Increase P-level to at least P-5.
4. Place the MNS magnets in the “Navigate” position and proceed with magnetic navigation.

Keep operating the Impella Catheter at a P-level of at least P-5 when the MNS magnets are in the “Navigate” position. If the P-level falls below P-3, the Impella Catheter may stop running.

To resume operation, follow the steps in Table 7.4.

During magnetic navigation of the mapping catheter, the motor current of the Impella Catheter may temporarily increase to the point that the catheter stops running. Table 7.4 explains how to resume operation.

When the MNS magnets are in the “Navigate” position, the displayed Impella Catheter flow may be artificially elevated. To accurately assess the flow rate, note the displayed flow when the magnets are in the “Stowed” position.

Table 7.4 Troubleshooting When Operating the Impella Catheter in the Presence of a MNS System

Observation	Actions
Unable to start Impella or Impella stops running	<ol style="list-style-type: none"> 1. Place the MNS magnets in the "Reduced" position and attempt to start the Impella Catheter. 2. If the Impella Catheter does NOT start with the magnets in the "Reduced" position, place the magnets in the "Stowed" position and start the Impella Catheter. 3. Increase the Impella Catheter P-level to P-3 or higher. 4. Place the MNS magnets in the "Navigate" position and proceed with magnetic navigation.
MNS magnets: "Navigate" Displayed flow seems too high or MNS magnets: "Stowed" Displayed flow drops	<p>The Impella Catheter displayed flow will be artificially elevated when the MNS magnets are in the "Navigate" position.</p> <p>The displayed flow will be accurate when the MNS magnets are in the "Stowed" position.</p>

Change Purge Fluid to Obtain Accurate Purge Values

To get accurate purge values after changing to a backup controller, perform the Change Purge Fluid bag procedure (described in section 5 of this manual) and replace the purge fluid bag.

TRANSFERRING FROM THE AUTOMATED IMPELLA CONTROLLER TO A NEW AIC

TRANSFER STEPS

A backup Automated Impella Controller (AIC) should be available at all times when a patient is on support. In the event that the controller fails, follow the steps below to transition the Impella Catheter to the backup controller.

1. Confirm that the backup controller is powered on and ready.
2. Disconnect the yellow luer connector from the Impella Catheter to release the pressure in the purge cassette and immediately reconnect.
3. Transfer the purge cassette and purge solution from the original controller to the backup controller.
4. Remove the white connector cable from the original controller and plug it into the catheter plug on the front of the backup controller.
5. Once the Impella Catheter is connected to the backup controller, wait for a message to appear on the screen asking you to confirm re-starting the Impella Catheter at the previously set P-level.
6. Press OK within 10 seconds to confirm restarting the Impella Catheter at the previously set P-level.
7. If the message to restart the Impella Catheter does not appear within 30 seconds, restart the Impella Catheter using the FLOW CONTROL soft button.

PATIENT MANAGEMENT CHECKLIST FOLLOWING TRANSFER OF SUPPORT

Questions or Concerns?

Contact the local Abiomed team or call the 24 hour clinical support line at 1-800-422-8666.

After transferring patient support to or from the Automated Impella Controller, perform each of the following patient management checklist items:

1. Confirm Impella Catheter placement using echocardiography.
2. Tighten the Tuohy-Borst valve (tighten all the way to the right) on the Impella Catheter to prevent catheter migration.

EMERGENCY SHUTDOWN PROCEDURE

In the unlikely event that the Automated Impella Controller software stops responding, follow the procedure below to restart the controller.

1. Press and hold the power switch for 30 seconds.
2. An "Emergency Shutdown Imminent" alarm will sound at 15 seconds.
3. The controller will shut down after 30 seconds.
4. Restart the controller.

ANTI-COAGULATION THERAPY WITH IMPELLA HEPARIN INFUSION

To maximize reliability, Impella pump motors require a constant purge using a dextrose solution in water with heparin (25 or 50 U/ml). In addition, Impella pumps are used in conjunction with heparin based anti-coagulation therapy. As a result, the heparin infused via the Impella purge system needs to be accounted for in institutional protocols, which include heparin for systemic anti-coagulation. Abiomed's recommendation on an optimal method to include Impella heparin infusion into an anti-coagulation protocol is provided below.

INCLUDING IMPELLA HEPARIN INFUSION IN HEPARIN ANTI-COAGULATION THERAPY

Anti-coagulation therapy protocols are extremely important for managing Impella pumps. These protocols usually include the use of heparin for systemic anti-coagulation, and careful monitoring of a patient's coagulation status using Activated Clotting Times (ACTs). During support with Impella pumps, the targeted ACT is 160-180 seconds. Depending on each patient's characteristics, different heparin doses are needed to maintain this ACT. This is accomplished by providing intravenous (IV) heparin infusions to maintain an optimal coagulation state, as monitored by ACT.

To optimize patient management on Impella support, anti-coagulation therapy utilizing heparin needs to account for the heparin delivered through the Impella purge system. Specifically, the heparin infused via the purge solution may provide a significant fraction of the heparin needed to maintain a patient's ACT. As a result, failure to account for the Impella heparin infusion can confound ACT maintenance, and potentially result in patients being in a hyper-coagulated state, leading to increased bleeding at the percutaneous and surgical access sites. A method to include Impella heparin infusion in an anti-coagulation protocol using heparin is described below.

Overall, the total heparin to a patient is the sum of the Impella Delivered Heparin (Heparin source: Impella purge), and the IV Heparin (Heparin source: drip):

$$\text{Total Heparin} = \text{Impella Delivered Heparin} + \text{IV Heparin} \quad (1)$$

If your protocol does not include an allowance for heparin from the Impella purge, but calls out a specific total heparin, the IV Heparin can be calculated as:

$$\text{IV Heparin} = \text{Total Heparin} - \text{Impella Delivered Heparin} \quad (2)$$

As a sample patient case, if your protocol specifies to use heparin at 10 U/kg/hour to maintain an acceptable ACT, and you have a 100 kg patient, your total heparin would be 1,000 U/hour.

If the Infusion History Screen on the AIC (see Figure 4.6) shows that the Impella purge provides 150 U/hour (50 U/mL heparin at a purge rate of 3 mL/hour), using equation (2), the correct IV Heparin would be 850 U/hour of heparin or 8.5 mL/hour for a saline bag with 100 U/mL.

Table 7.5 provides additional clinical scenarios.

Table 7.5 Clinical scenarios for anti-coagulation therapy with the Impella purge system heparin (50 U/ml).

Scenario #1 – Total heparin = 8 U/kg/hour; IV Heparin Concentration = 100 U/mL		
Patient Weight (kg)	Impella Purge [^] Flow (mL/hour)	IV Heparin (mL/hour)
75	10	1
	15	-1.5†
	20	-4†
100	10	3
	15	0.5
	20	-2†
125	10	5
	15	2.5
	20	0*
Scenario #2 - Total heparin = 10 U/kg/hour; IV Heparin Concentration = 100 U/mL		
Patient Weight (kg)	Impella Purge [^] Flow (mL/hour)	IV Heparin (mL/hour)
75	10	2.5
	15	0*
	20	-2.5†
100	10	5
	15	2.5
	20	0*
125	10	7.5
	15	5
	20	2.5
Scenario #3- Total heparin = 12 U/kg/hour; IV Heparin Concentration = 100 U/mL		
Patient Weight (kg)	Impella Purge [^] Flow (mL/hour)	IV Heparin (mL/hour)
75	10	4
	15	1.5
	20	-1†
100	10	7
	15	4.5
	20	2
125	10	10
	15	7.5
	20	5

[^] Impella purge heparin = 50 U/mL
* scenario where discontinuation of systemic heparin therapy should be assessed.
† scenario where use of Impella purge heparin = 25 U/mL should be assessed.

As noted in Table 7.5 (denoted with *), for some patients, the Impella purge system may provide a full heparin dose (IHD = THD). For these patients, systemic IV heparin therapy may not be needed. In addition, for other patients (denoted with †), the Impella purge system may provide too much heparin. For these patients, in order to maintain an optimal ACT, use of a purge fluid with a lower heparin concentration (25 U/mL) should be considered. Table 7.6 provides a corrected patient scenarios table for these cases.

Table 7.6 Patient scenarios for anti-coagulation therapy with the Impella purge system heparin (25 U/mL).

Scenario #1 – Total heparin = 8 U/kg/hour; IV Heparin Concentration = 100 U/mL		
Patient Weight (kg)	Impella Purge† Flow (mL/hour)	IV Heparin (mL/hour)
75	15	2.25
75	20	1
100	20	3
Scenario #2 – Total heparin = 10 U/kg/hour; IV Heparin Concentration= 100 U/mL		
Patient Weight (kg)	Impella Purge† Flow (mL/hour)	IV Heparin (mL/hour)
75	20	2.5
Scenario #2 - Total heparin = 10 U/kg/hour; IV Heparin Concentration = 100 U/mL		
Patient Weight (kg)	Impella Purge^ Flow (mL/hour)	IV Heparin (mL/hour)
75	20	4

† Impella purge heparin = 25 U/mL

Please contact Abiomed's Clinical Support Center, 1-800-422-8666, if you have questions.

8 AUTOMATED IMPELLA CONTROLLER™ ALARMS

ALARMS OVERVIEW	8.1
Alarm Levels	8.1
Alarm Display	8.2
Mute Alarm Function	8.2
Alarm History Screen	8.2
ALARM MESSAGE SUMMARY	8.3

Page intentionally left blank.

ALARMS OVERVIEW

The Automated Impella Controller monitors various functions to determine whether specific operational parameters are within expected limits. When a parameter goes outside of its specified limits, the Automated Impella Controller sounds an alarm tone and displays an alarm message that can be viewed on the display screen on the front of the controller. When the alarm sounds, the operator will need to move to the front of the controller to view the alarm. The alarm tone indicates the severity of the alarm. The alarm message on the display screen is color-coded for severity and provides details on the cause of the alarm and how to resolve the alarm. After muting an alarm, if another alarm occurs it will only be heard and displayed if it is a higher priority alarm than the one that was muted.

ALARM LEVELS

Alarms are divided into three levels of severity:

- Advisory (white)
- Serious (yellow)
- Critical (red)

Table 8.1 Alarm Levels

Category	Description	Audible Indicator*	Visual Indicator
Advisory	Notification	1 beep every 5 minutes	Alarm header on white background
Serious	Abnormal situation. Prompt action needed.	3 beeps every 15 seconds	Alarm header on yellow background
Critical	High priority. Immediate action needed.	10 beeps every 6.7 seconds	Alarm header on red background

* Sound pressure of audible alarm indicators is >67 dBA

For some alarms, there is a short delay between the triggered event and the audible annunciation and visual display of the alarm. (For more information, refer to the “Alarm Delay Information” discussion in section 9 of this manual.)

ALARM DISPLAY

The alarm window is located in the upper left region of the display screen on the front of the Automated Impella Controller (see Figure 8.1). Alarms are listed in order of priority, with the highest priority alarm at the top. Up to three alarms may be displayed at one time. The colored background behind the highest priority alarm will alternate between two shades of that color. The white panel displayed to the right of the alarm header contains instructions for resolving the alarm condition. The instructions should be followed in the order given.

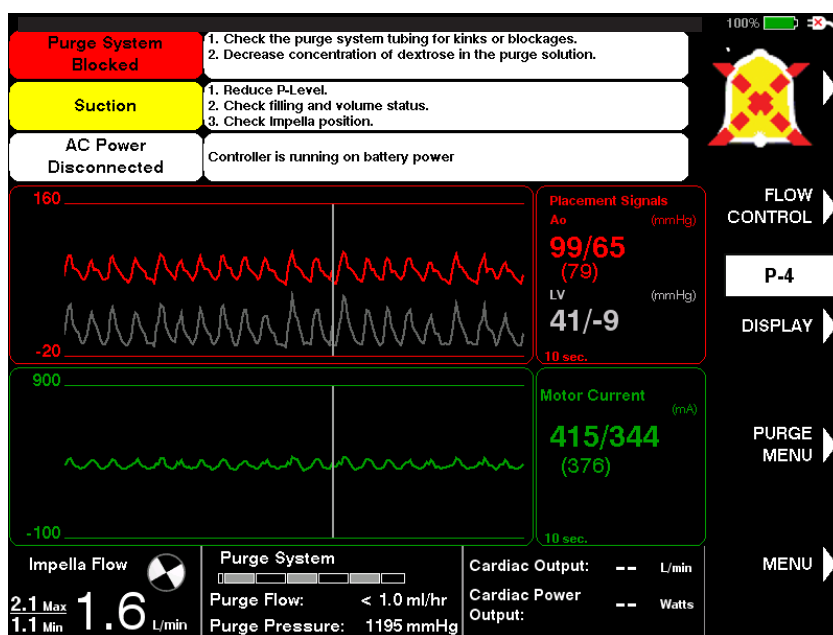

Figure 8.1 Alarm Window

Alarms That Resolve On Their Own

The audible indicator will shut off if an alarm condition is resolved before you press **MUTE ALARM**. The visual message, however, will continue to be displayed, with the alarm header on a gray background, for 20 minutes or until you press **MUTE ALARM**. This allows you to identify the alarm that occurred.

MUTE ALARM FUNCTION

Pressing the **MUTE ALARM** button on the upper right of the Automated Impella Controller display screen will silence the audible alarm indicator for 2 minutes (for red or yellow alarms) or 5 minutes (for white advisory alarms). When an alarm is silenced, the words “MUTE ALARM” next to the button are replaced by the mute alarm indicator, a crossed-out bell icon (as shown in Figure 8.1).

ALARM HISTORY SCREEN

The alarm history screen may be accessed through the **MENU**. This screen contains a log of the alarms that occurred during the case. This log is maintained when the Automated Impella Controller is powered down or after a power failure. The controller also maintains a long-term log that is saved after the Automated Impella Controller is powered down or after a power failure and this information may be downloaded by Abiomed personnel.

ALARM MESSAGE SUMMARY

Table 8.2 briefly describes all of the alarm messages that may appear on the Automated Impella Controller when used with the Impella catheters.

Table 8.2 Automated Impella Controller Alarm Messages

Severity	Alarm Header	Action	Cause
Critical Alarms	Air in Purge System	The purge system has stopped. Press the Purge Menu soft key then select De-Air Purge System.	There is air in the purge tubing.
	Battery Critically Low	Plug controller into AC power.	Battery power has 15% remaining capacity.
	Battery Failure	<ol style="list-style-type: none"> 1. Plug controller into AC power. 2. Press switch located on the underside of the controller. 3. Switch to backup controller. 	A battery switch is turned off or there is a malfunction of the switch.
	Battery Failure	Plug controller into AC power.	One of the batteries has failed.
	Battery Temperature High	Switch to backup controller.	Battery temperature is greater than 60°C.
	Complete Procedure	<ol style="list-style-type: none"> 1. Follow the steps on the screen or 2. Exit the procedure 	Complete Procedure serious alarm (yellow; see next page) is active and the user has not responded for an additional 2 minutes.
	Controller Failure	Switch to backup controller.	There is a problem with the controller electronics.
	Controller Failure	The purge system has stopped. Switch to backup controller.	The controller has detected a purge pressure sensor defect and has stopped the purge system.
	Emergency Shutdown Imminent	Release ON/OFF push button.	Power switch pressed for 15 seconds while Impella is still connected.
	Impella Disconnected	<ol style="list-style-type: none"> 1. Check cable connection to console. 2. Check Impella connection to cable. 	Running Impella Catheter disconnected.
	Impella Failure	Replace Impella.	There is a problem with the Impella Catheter motor.
	Impella Position In Ventricle	<ol style="list-style-type: none"> 1. Reduce the P-level to P-2. 2. When ready to position, press the MENU soft key then select Repositioning Guide 	Controller has detected that Impella Catheter is fully in the ventricle.
	Impella Position in Aorta	<ol style="list-style-type: none"> 1. Reduce the P-level to P-2 until imaging is available. 2. Reposition with imaging. 3. Return to preferred P-level and confirm positioning with imaging. 	Controller has detected that Impella Catheter is fully in the aorta.

Table 8.2 Automated Impella Controller Alarm Messages (continued)

Severity	Alarm Header	Action	Cause
Critical Alarms	Impella Stopped Retrograde Flow	To prevent retrograde flow, restart Impella or withdraw pump from ventricle.	Impella Catheter is not running; possible retrograde flow through Impella Catheter.
	Impella Stopped	<ol style="list-style-type: none"> 1. Restart Impella. 2. Replace Impella after 3rd unsuccessful restart attempt. 	There may be a mechanical or electrical problem in the Impella Catheter.
	Impella Stopped	<ol style="list-style-type: none"> 1. Replace white connector cable. 2. Switch to backup controller. 3. Replace Impella Catheter. 	There is a problem with the electronics.
	Impella Stopped Controller Failure	Attempt to restart catheter was unsuccessful. Switch to backup controller.	There is a problem with the controller electronics.
	Impella Stopped Motor Current High	<ol style="list-style-type: none"> 1. Restart Impella. 2. Replace Impella after 3rd unsuccessful restart attempt. 	There is a problem with the Impella Catheter motor.
	Purge Disc Not Detected	Reinsert Purge Disc.	The controller is not detecting that the purge disc is clicked into the front of the controller.
	Purge Pressure Low	<ol style="list-style-type: none"> 1. Check purge system tubing for leaks. 2. Increase concentration of dextrose in the purge solution. 3. Press the Purge Menu soft key then select Change Cassette and Bag. 	Purge pressure has dropped below 300 mmHg with the purge flow ≥ 30 mL/hr for 30 seconds or longer.
	Purge System Blocked	<ol style="list-style-type: none"> 1. Check all purge system tubing for kinks or blockages. 2. Decrease concentration of dextrose in the purge solution. 	<p>Purge flow has dropped below 1 mL/hr.</p> <p>Kinked or blocked purge connecting tube.</p> <p>Kinked or blocked purge lumen in Impella Catheter.</p>
	Purge System Failure	<ol style="list-style-type: none"> 1. Replace Purge Cassette. Press the Purge Menu soft key then select Change Cassette and Bag. 2. Switch to backup controller. 	There is a problem with the purge cassette or purge unit driver.
	Purge System Open	<ol style="list-style-type: none"> 1. Check the purge system tubing for open connections or leaks. 2. Press the Purge Menu soft key then select Change Cassette and Bag. 	Purge pressure has dropped below 100 mmHg for 20 seconds or longer.
Retrograde Flow	Check for high afterload pressure.	Retrograde flow detected at high motor speed.	

Table 8.2 Automated Impella Controller Alarm Messages (continued)

Severity	Alarm Header	Action	Cause
Serious Alarms	Battery Comm. Failure	Plug controller into AC power.	Loss of communication to the battery.
	Battery Level Low	Plug controller into AC power.	Battery has 50% remaining capacity.
	Battery Temperature High	1. Check controller for blocked air vents. 2. Switch to backup controller.	Battery temperature is greater than 50°C and less than or equal to 60°C.
	Complete Procedure	1. Follow the steps on the screen or 2. Exit the procedure	User has not responded to a de-air or purge procedure screen for more than 1 minute or a transfer to standard configuration screen for more than 5 minutes.
	Controller Error	Switch to backup controller.	There is a problem with the controller electronics.
	Defective Purge Cassette	Replace Purge Cassette. Press the Purge Menu soft key then select Change Cassette and Bag.	There is a problem with the purge cassette hardware.
	Impella Catheter Not Supported	1. Replace Impella with supported catheter (2.5, CP, 5.0, LD, RP). 2. Contact Abiomed Service to upgrade Impella Controller.	The Impella Catheter is not supported to operate with the current version of controller software and/or hardware.
	Impella Defective	Do not use Impella. Replace Impella.	There is a problem with the Impella Catheter electronics.
	Impella Stopped Controller Failure	Attempting to restart catheter. Locate backup controller.	Restart was unsuccessful within 30 seconds
	Placement Signal Low	Ao diastolic placement signal is low, assess cardiac function. Confirm Impella position with imaging. Reposition if necessary	Minimum Ao placement signal value is less than 30 mmHg and motor current is pulsatile
	Placement Signal not Reliable	Placement and Suction Monitoring are Suspended 1. Monitor patient hemodynamics and Impella position with imaging. 2. Check the patient cable for kinks.	There is a problem with the Impella Catheter sensor signal.
	Purge Volume Critically Low	Press the Purge Menu soft key then select Change Purge Fluid Bag.	There are 15 mL (in addition to 5% of the starting bag volume) or fewer remaining in the purge fluid bag.
	Reinstall Software	Software installation was unsuccessful. Reinstall software.	Software was not installed successfully.
Suction	1. Reduce P-level. 2. Check Impella position. 3. Check filling and volume status.	Suction is detected.	

Table 8.2 Automated Impella Controller Alarm Messages (continued)

Severity	Alarm Header	Action	Cause
Advisory Alarms	AC Power Disconnected	Controller is running on battery power.	AC power was disconnected.
	Adjust LV Signal	Press MENU soft key, then select Adjust LV Signal	Suggested adjustment available
	Audio Off	The audio for the following alarm has been disabled. <Alarm will be listed here>	User has disabled audio for Placement Signal Not Reliable, Purge Pressure High, Purge System Blocked, Suction, Placement Signal Low, or Placement Signal Lumen Blocked alarm.
	Enter Cardiac Output	Press MENU soft key then select Enter Cardiac Output	Cardiac Output and Cardiac Power Output values are going to timeout
	Impella Position Unknown	Impella position unknown due to low pulsatility, assess cardiac function.	Impella Catheter position unknown due to low pulsatility.
	Optical Sensor Not Supported	Placement and Suction Monitoring are Not Available 1. Monitor Impella position with imaging. 2. Switch to Controller which supports optical pressure sensor.	The optical sensor is not supported with the current version of the controller hardware. The pump will still operate without placement or suction monitoring
	Purge Cassette Incompatible	Contact Abiomed Service to update Impella Controller.	Incompatible purge cassette RFID version.
	Purge Flow Decreased	The purge flow has decreased by 2.5 mL/hr or more. This is a notification only; no action is required.	Purge flow has decreased by ≥ 2.5 mL/hr.
	Purge Flow Increased	The purge flow has increased by 2.5 mL/hr or more. This is a notification only; no action is required.	Purge flow has increased by ≥ 2.5 mL/hr.
	Purge Volume Low	1. Press the PURGE MENU soft key then select Change Purge Fluid Bag. 2. Follow the instructions to change the purge fluid.	There are 30 mL (in addition to 5% of the starting bag volume) or fewer remaining in the purge fluid bag.
Surgical Mode Enabled	Impella pump stopped. Purge system running. 'Impella Stopped' alarm disabled. To exit this mode start Impella pump.	Surgical Mode has been enabled to silence "Impella Stopped" alarm at P-0.	
Unexpected Controller Shutdown	Switch to backup controller if condition persists.	Unexpected restart of controller due to software or hardware failures.	

9 GENERAL SYSTEM INFORMATION



TERMINOLOGY, ABBREVIATIONS, AND SYMBOLS	9.1
Terminology and Abbreviations.....	9.1
Symbols.....	9.1
AUTOMATED IMPELLA CONTROLLER MECHANICAL SPECIFICATIONS.....	9.3
AUTOMATED IMPELLA CONTROLLER ELECTRICAL SPECIFICATIONS.....	9.3
EQUIPMENT DESIGN	9.4
EQUIPMENT CLASSIFICATIONS.....	9.4
FEDERAL COMMUNICATIONS COMMISSION (FCC) NOTICE	9.5
ELECTROMAGNETIC COMPATIBILITY	9.5
USE OF EXTRACORPOREAL MEMBRANE OXYGENATION (ECMO) WITH IMPELLA PATIENTS IN CARDIOGENIC SHOCK.....	9.6
TRANSPORT BETWEEN HOSPITALS.....	9.7
Guidelines for Patient Transport.....	9.7
Important Transport Considerations.....	9.7
FAA Advisory.....	9.8
VGA MONITOR CONNECTION	9.12
ALARM DELAY INFORMATION	9.13
PATIENT ENVIRONMENT	9.13
USE ENVIRONMENT.....	9.13
IMPELLA CATHETER PARAMETERS	9.14
TECHNICAL SPECIFICATIONS	9.15
IMPELLA 5.5 WITH SMARTASSIST CATHETER DIMENSIONS.....	9.15
CLEANING	9.16
STORING THE AUTOMATED IMPELLA CONTROLLER.....	9.16
RETURNING AN IMPELLA CATHETER TO ABIOMED (UNITED STATES)	9.16

TERMINOLOGY, ABBREVIATIONS, AND SYMBOLS

TERMINOLOGY AND ABBREVIATIONS

Table 9.1 Terminology and Abbreviations

Catheter serial number	Identification number of the Impella Catheter; stated on the package label, on the red Impella plug, and the Automated Impella Controller display screen
Dextrose and Glucose	The terms “dextrose” and “glucose” are used interchangeably to refer to the solution used as purge fluid for the Impella System
Hz	Hertz
Motor housing (or pump housing)	Enclosure of the Impella Catheter motor
Pump	Central delivery unit of the Impella Catheter, consisting of the motor, motor housing, cannula with inlet and outlet
Purge pressure	Pressure present in the Impella Catheter and in the infusion line
Purge system	Impella purge cassette used for rinsing the Impella Catheter
Retrograde flow	Reverse flow through the cannula when the Impella Catheter is at a standstill (eg, regurgitation)
V	Volt
VA	Volt ampere (Watt)

SYMBOLS

Table 9.2 Symbols



























	Caution; consult instructions for use
	Defibrillator-proof type CF equipment
	Keep dry
	Storage temperature (eg, -15°C to 50°C)
	Declares conformity with Directive 93/42/EEC for medical devices, and with Directive 2011/65/EU on the restriction of the use of certain hazardous substances in electrical and electronic equipment
	Date of manufacture (eg, October 1, 2014)

Table 9.2 Symbols (continued)

	Protect from sunlight
	Symbol for lot designation; the manufacturer's lot designation must be stated after the LOT symbol
REF 123456	Abiomed part number (eg, part number 123456)
SN 123456	Manufacturer's serial number (eg, serial number 123456)
Non Sterile!	The product is not sterile
 2016-06-01	Use-by date (eg, use before June 1, 2016)
	Do not reuse
	Sterilized using ethylene oxide
	Electric scrap; must be disposed of separately. Must not be disposed of as domestic waste.
	Protective Earth
	ON / OFF
	Alternating current (AC) only
	Equipotentiality
	Fuse
	Non-ionizing electromagnetic radiation
	USB port
	CAT 5 Port (Ethernet)
	MR Unsafe
 Do Not Flush 	Do NOT flush
 Glucose	Use glucose in the purge fluid
 NaCl 	Use saline in the pressure bag; squeeze at the green arrows to flush

AUTOMATED IMPELLA CONTROLLER MECHANICAL SPECIFICATIONS

Table 9.3 Mechanical Specifications for the Automated Impella Controller

Parameter	Specification
Model Number	0042-0000-US
Temperature	Operating: 10°C to 40°C (50°F to 104°F) Storage: -15°C to 50°C (5°F to 122°F)
Relative Humidity	Operating: 95% Storage: 95%
Atmospheric Pressure	Operating: 8000 ft (750 hPa) to -1000 ft (1050 hPa) Storage: 18,000 ft (500 hPa) to -1000 ft (1050 hPa)
Dimensions	Height: 351 mm (13.8 in) Width: 443 mm (17.4 in) Depth: 236 mm (9.3 in)
Dimensions – Packaged	Height: 508 mm (20.0 in) Width: 559 mm (22.0 in) Depth: 406 mm (15.0 in)
Weight	Maximum: 11.8 kg (26.1 lbs)
Weight – Packaged	Maximum: 13.6 kg (30 lbs)
Maintenance and repair interval	12 months (Work must be performed by technicians authorized by Abiomed who have completed Abiomed's Service Training Certification Program)

AUTOMATED IMPELLA CONTROLLER ELECTRICAL SPECIFICATIONS

Table 9.4 Electrical Specifications for the Automated Impella Controller

AC operation	100-230 V AC (nominal); 47-63 Hz; 1.1 A
Internal battery operation	14.4 V DC (nominal); lithium ion
Characteristic values	
Max. power consumption under load	120 VA
Fuses	2 Amp. 250 V. 5 mm x 20 mm, slow-blow fuses
Running time without AC power with fully charged batteries	At least 60 minutes (charging duration of at least 5 hours)
Electrical system	Installation in accordance with pertinent regulations is required for use in medical facilities (eg, IEC stipulations).

NOTE: Circuit diagrams available upon request.

EQUIPMENT DESIGN

The Automated Impella Controller conforms to the applicable requirements of the following standards:

- IEC 60601-1: 2012 Edition 3.1 *Medical Electrical Equipment Part 1: General Requirements for Basic Safety and Essential Performance*
- CSA C22.2#60601-1 (2014) Ed:3 *Medical Electrical Equipment Part 1: General Requirements for Basic Safety and Essential Performance*
- AAMI ES60601-1:2005 +C1:A2 *Medical Electrical Equipment Part 1: General Requirements for Basic Safety and Essential Performance*
- IEC 60601-1-2:2014 Edition 4, *Medical Electrical Equipment – Part 1-2: General Requirements for Basic Safety and Essential Performance – Collateral Standard: Electromagnetic Disturbances – Requirements and Tests*
- IEC 60601-1-6:2010, AMD1:2013 *Medical Electrical Equipment – Part 1-6: General Requirements for Safety – Collateral Standard: Usability*
- IEC 60601-1-8:2006, AM1:2012 *Medical Electrical Equipment – Part 1-8: General Requirements for Safety – Collateral Standard: General Requirements, Tests and Guidance for Alarm Systems in Medical Electrical Equipment and Medical Electrical Systems*
- IEC 62304:2015 *Medical Device Software - Software Life-cycle Processes*
- RTCA DO160G *Environmental Conditions and Test Procedures for Airborne Equipment*
- AIM 7351731 *Medical Electrical Equipment and System Electromagnetic Immunity Test for Exposure to Radio Frequency Identification Readers*

EQUIPMENT CLASSIFICATIONS

Table 9.5 Equipment Classifications

Type of protection against electric shock	IEC 60601-1: Class I degree of protection: CF defibrillation-proof and internally powered. Relies not only on basic insulation against shock, but also includes additional protection. Accomplished by providing means for connecting the equipment to the protective earth conductor of the fixed wiring of the installation in a way that prevents accessible metal parts from becoming live if basic insulation fails.
Degree of protection against electric shock for Automated Impella Controller	Class I Equipment
Mode of operation	Continuous
Degree of protection against explosion hazard	Not suitable for use in the presence of a flammable anesthetic mixture with air or with oxygen or nitrous oxide. Also not suitable for use in an oxygen-enriched atmosphere.
Degree of protection against harmful ingress of water	IEC 60529: IPX1 protected against dripping water.

FEDERAL COMMUNICATIONS COMMISSION (FCC) NOTICE

This device complies with Part 15 of the FCC Rules. Operation is subject to the following two conditions:

1. This device may not cause harmful interference.
2. This device must accept any interference received, including interference that may cause undesired operation.

Changes or modifications not expressly approved by Abiomed, Inc. could void the user's authority to operate this device.

NOTE: "Harmful interference" is defined by the FCC as follows: Any emission, radiation or induction that endangers the functioning of a radio navigation service or of other safety services or seriously degrades, obstructs or repeatedly interrupts a radiocommunications service operating in accordance with FCC rules.

ELECTROMAGNETIC COMPATIBILITY



Medical electrical equipment needs special precautions regarding EMC and needs to be installed and put into service according to the electromagnetic compatibility (EMC) information provided in this document.



Portable and mobile RF communications equipment can affect medical electrical equipment.



The equipment or system should not be used adjacent to or stacked with other equipment. If adjacent or stacked use is necessary, the equipment or system should be observed to verify normal operation in the configuration in which it will be used.



Use of cables, other than those sold by Abiomed, may result in increased emissions or decreased immunity of the Automated Impella Controller.



The Automated Impella Controller uses RFID (radio frequency identification) to identify and communicate with the purge cassette. Other equipment may interfere with the Automated Impella Controller even if that other equipment complies with CISPR emission requirements.



The Automated Impella Controller (AIC) performs as intended when exposed to radiofrequency (RF) disturbances below 20 V/m. During transport, the AIC may be exposed to RF disturbances above 20 V/m, which could cause minor problems, such as intermittent displays of soft button menu selections, which have no effect on the operating parameters of the Impella support system, and will resolve readily once the disturbance ends. It could also potentially result in loss of support. Patients must be closely monitored at all times during transport.



Do not transport an Impella patient via commercial aircraft. Loss of support may occur aboard a commercial aircraft due to exposure to radiofrequency (RF) disturbances above the compliance level (<20 V/m) of the Automated Impella Controller.

NOTE: The EMC tables and other guidelines that are included in this manual provide information to the customer or user that is essential in determining the suitability of the equipment or system for the electromagnetic environment of use, and in managing the electromagnetic environment of use permit the equipment or system to perform to its intended use without disturbing other equipment and systems or non-medical electrical equipment. For the electromagnetic testing (detailed in the following tables), the AIC Essential Performance was specified as: *during the entire testing period, the AIC continues to provide support to the patient.*

USE OF EXTRACORPOREAL MEMBRANE OXYGENATION (ECMO) WITH IMPELLA PATIENTS IN CARDIOGENIC SHOCK



If the use of Extra-corporeal Membrane Oxygenation (ECMO) is to be initiated in a cardiogenic shock patient currently being treated with Impella, the benefits and risks of continuing Impella therapy for left ventricle unloading during ECMO support should be considered.

If a clinical decision is made to initiate Extra-corporeal Membrane Oxygenation (ECMO) to treat cardiogenic shock (CS), the benefits and risks of continuing Impella therapy for left ventricle unloading during ECMO support should be considered. Use of ECMO in CS patients has been shown to result in additional loading of the left ventricle (LV), which the Impella Catheter alleviates, based on its favorable unloading properties, and use of Impella in these patients has been shown to improve outcomes (versus ECMO alone).¹

For CS patients treated with both ECMO and Impella unloading, the flow from the Impella device should be monitored and may need to be reduced to minimize the occurrence of a LV inflow limited condition (suction). If this condition occurs, the Automatic Impella Controller will alarm to notify the user.

If a clinical decision is made to wean a CS patient treated with both ECMO and Impella unloading to allow assessment of residual myocardial function, support should be decreased by gradually lowering the ECMO flow, while increasing the Impella Catheter flow. If a patient tolerates the reduction in the ECMO flow, they can be transitioned to Impella support alone for continued LV recovery.

1. References available upon request.

TRANSPORT BETWEEN HOSPITALS



The Automated Impella Controller™ (AIC) performs as intended when exposed to radiofrequency (RF) disturbances below 20 V/m. During transport, the AIC may be exposed to RF disturbances above 20 V/m, which could cause minor problems, such as intermittent displays of soft button menu selections, which have no effect on the operating parameters of the Impella support system, and will resolve readily once the disturbance ends. It could also potentially result in loss of support. Patients must be closely monitored at all times during transport.



Do not transport an Impella patient via commercial aircraft. Loss of support may occur aboard a commercial aircraft due to exposure to radiofrequency (RF) disturbances above the compliance level (<20 V/m) of the Automated Impella Controller.

GUIDELINES FOR PATIENT TRANSPORT

Intra-hospital transport may be required if a patient requires additional resources and specialized teams located at another hospital. The patient may be transferred to such a location using the Automated Impella Controller for hospital-to-hospital transport via ambulance, or helicopter, or fixed-wing aircraft specially outfitted and equipped for transport of critically ill patients. Do not transport the patient via commercial aircraft. Loss of support may occur aboard a commercial aircraft due to exposure to extreme radiofrequency (RF) disturbances.

Patients must be closely monitored at all times during transport. Maintaining optimal patient hemodynamic status and correct Impella Catheter position are two key factors in managing patients supported with the Impella Ventricular Support Systems during transport. Steps should be taken to eliminate or minimize any aspect of the transport that might adversely affect these factors.

The Automated Impella Controller is designed to operate for 60 minutes on battery power. Transport teams should take this into consideration when planning the transport. If the total transport time is expected to include more than 60 minutes during which the system will be disconnected from AC power, arrangements should be made to use a vehicle with a built-in DC to AC power inverter.

IMPORTANT TRANSPORT CONSIDERATIONS

1. Planning is critical to success. Abiomed representatives can help with planning for transport. They can be contacted 24 hours a day at 1-800-422-8666.
2. The Automated Impella Controller should be fully charged prior to transport. Keep the Automated Impella Controller connected to AC power (or an AC inverter) whenever possible.
3. Do not stress the connector cable from the controller to the Impella Catheter. Such tension could move the catheter out of correct position and compromise patient circulatory support.
4. Carefully monitor purge pressures during changes in altitude.
5. The Automated Impella Controller should be positioned to allow easy access to the display screen and soft buttons to view alarms and make any necessary changes.
6. Maintain ACTs between 160 and 180 or at the level recommended by the physician responsible for the patient.

FAA ADVISORY

The Automated Impella Controller has been subjected to, and passed, the EMC/EMI tests as specified in IEC 60601-1-2 (General requirements for basic safety and essential performance—Collateral standard: Electromagnetic compatibility—Requirements and tests). The Automated Impella Controller does not, however, meet the requirements for conducted emissions of RTCA/DO-160G section 21.4 and has not been tested for radiated emissions per RTCA/DO-160G section 21.5. Abiomed recommends that air transport carriers follow the guidance FAA Advisory Circular AC No: 91-21.1B. Section 8-a of FAA Advisory Circular AC No: 91-21.1B states:

“Equipment tested and found to exceed the section 21, Category M, emission levels are required to be evaluated in the operator’s M-PED selected model aircraft for electromagnetic interference (EMI) and radio frequency interference (RFI). All navigation, communication, engine, and flight control systems will be operating in the selected aircraft during the evaluation.”

Table 9.6 Guidance and Manufacturer’s Declaration - Emissions, All Equipment and Systems

The Automated Impella Controller is intended for use in the electromagnetic environment specified below. The customer or user of the Automated Impella Controller should ensure that it is used in such an environment.		
Emissions Test	Compliance	Electromagnetic Enforcement – Guidance
RF Emissions CISPR 11	Group 1	The Automated Impella Controller uses RF energy only for its internal function. Therefore, its RF emissions are very low and are not likely to cause any interference in nearby electronic equipment.
	Class A	The Automated Impella Controller is suitable for use in all locations other than those located in residential environments and those directly connected to a low voltage power supply network which supplies buildings used for domestic purposes"
Harmonics IEC 61000-3-2	Class A	
Flicker IEC 61000-3-3	Complies	

NOTE: The EMISSIONS characteristics of this equipment make it suitable for use in industrial areas and hospitals (CISPR 11 class A). If it is used in a residential environment (for which CISPR 11 class B is normally required) this equipment might not offer adequate protection to radio-frequency communication services. The user might need to take mitigation measures, such as relocating or re-orienting the equipment.

Table 9.7 Guidance and Manufacturer's Declaration - Immunity

The Automated Impella Controller is intended for use in the electromagnetic environment specified below. The customer or user of the Automated Impella Controller should ensure that it is used in such an environment.

Immunity Test	IEC 60601 Test Level	Compliance Level	Electromagnetic Environment – Guidance
Electrostatic Discharge (ESD) IEC 61000-4-2	±8 kV contact ±15 kV air	±8 kV contact ±15 kV air	The relative humidity should be at least 5%.
Electrical Fast Transient/burst IEC 61000-4-4	±2 kV Mains ±1 kV for input/ output lines	±2 kV Mains ±1 kV for input/ output lines	Mains power quality should be that of a typical commercial or hospital environment.
Surge IEC 61000-4-5	±1 kV Differential ±2 kV Common	±1 kV Differential ±2 kV Common	Mains power quality should be that of a typical commercial or hospital environment.
Voltage dips, short interruptions and voltage variations on power supply input lines IEC 61000-4-11	> 95% dip for 0.5 cycle 60% dip for 5 cycles 30% dip for 25 cycles > 95% dip for 5 seconds	> 95% dip for 0.5 cycle 60% dip for 5 cycles 30% dip for 25 cycles > 95% dip for 5 seconds	Mains power quality should be that of a typical commercial or hospital environment. If the user of the Automated Impella Controller requires continued operation during power mains interruptions, it is recommended that the Automated Impella Controller be powered from an uninterruptible power supply or battery.
Power Frequency 50/60 Hz Magnetic Field IEC 61000-4-8	30 A/m	30 A/m	Power frequency magnetic fields should be that of a typical location in a typical commercial or hospital environment.

Table 9.8 Guidance and Manufacturer's Declaration - Emissions, Equipment and System that are life-supporting that are life-supporting

The Automated Impella Controller is intended for use in the electromagnetic environment specified below. The customer or user of the Automated Impella Controller should ensure that it is used in such an environment.

Immunity Test	IEC 60601 Test Level	Compliance Level	Electromagnetic Environment – Guidance
Conducted RF IEC 61000-4-6	10 Vrms 150 kHz to 80 MHz	10 Vrms	Portable and mobile RF communications equipment should be separated from the Automated Impella Controller by no less than the recommended separation distances calculated/listed below: $d = 0.35\sqrt{P}$
Radiated RF IEC 61000-4-3	10 V/m 80 MHz to 2.5 GHz	20 V/m	$d = 0.6\sqrt{P}$ 80 to 800 MHz $d = 1.2\sqrt{P}$ 800 MHz to 2.5 GHz

Where P is the maximum power rating in watts and d is the recommended separation distance in meters.

Field strengths from fixed transmitters, as determined by an electromagnetic site survey^(a), should be less than the compliance level in each frequency range.^(b)

Interference may occur in the vicinity of equipment marked with the following symbol: 

NOTE 1: At 80 MHz and 800 MHz, the higher frequency range applies.

NOTE 2: These guidelines may not apply in all situations. Electromagnetic propagation is affected by absorption and reflection from structures, objects, and people.

^(a) Field strengths from fixed transmitters, such as base stations for radio (cellular/cordless) telephones and land mobile radios, amateur radio, AM and FM radio broadcast and TV broadcast cannot be predicted theoretically with accuracy. To assess the electromagnetic environment due to fixed RF transmitters, an electromagnetic site survey should be considered. If the measured field strength in the location in which the Impella Controller is used exceeds the applicable RF compliance level above, the Impella Controller should be observed to verify normal operation. If abnormal performance is observed, additional measures may be necessary, such as re-orienting or relocating the Impella Controller.

^(b) Over the frequency range 150 kHz to 80 MHz, field strengths should be less than 10 V/m

Immunity Test	Compliance Level
Avionics RTCA DO-160G	
Conducted RF Section 20.4	Category R 10 MHz - 400MHz
Radiated RF Section 20.5	Category T (c) 100 MHz - 8 GHz

(c) the AIC will not maintain its essential performance when subjected to Category R Levels (radiated RF at a field strength of 150 V/m).

Immunity Test	RFID Specification	Frequency	Text Level (RMS)
RFID AIM 7351731:2017			
	ISO 14223	134.2kHz	65 A/m
	ISO/IEC 14443-3 (Type A)	13.56 MHz	7.5 A/m
	ISO/IEC 14443-4 (Type B)	13.56 MHz	7.5 A/m
	ISO/IEC 15693 (ISO 18000-3 Mode 1)	13.56 MHz	12 A/m
	ISO/IEC 18000-7	433 MHz	3 V/m
	ISO/IEC18000-63 Type Ca	890-960 MHz	54 V/m
	ISO/IEC 18000-4 Mode 1	2.45 GHz	54 V/m

Table 9.9 Recommended Separation Distances Between Portable and Mobile RF Communications Equipment and the Automated Impella Controller, Equipment and Systems that are Life-Supporting

The Automated Impella Controller is intended for use in the electromagnetic environment in which radiated disturbances are controlled. The customer or user of the Automated Impella Controller can help prevent electromagnetic interference by maintaining a minimum distance between portable and mobile RF communications equipment and the Automated Impella Controller as recommended below, according to the maximum output power of the communications equipment.

Rated Maximum Output Output Power of Transmitter (Watts)	Recommended Separation Distances for the Automated Impella Controller (m)		
	150 KHz to 80 MHz $d = 0.35\sqrt{P}$	80 to 800 MHz $d = 0.6\sqrt{P}$	800 MHz to 2.5 GHz $d = 1.2\sqrt{P}$
0.01	0.04	0.06	0.12
0.1	0.11	0.19	0.38
1	0.35	0.6	1.2
10	1.11	1.9	3.8
100	3.5	6.0	12

For transmitters rated at a maximum output power not listed above, the recommended separation distance (d) in meters (m) can be determined using the equation applicable to the frequency of the transmitter, where P is the maximum output power rating of the transmitter in watts (W) according to the transmitter manufacturer.

NOTE 1: At 80 MHz and 800 MHz, the separation distance for the higher frequency range applies.

NOTE 2: These guidelines may not apply in all situations. Electromagnetic propagation is affected by absorption and reflection from structures, objects, and people.

Table 9.10 RFID Transmitter / Receiver Specifications

Frequency	13.56 MHz
Receiver bandwidth	14 kHz
Effective radiated power	30 nW
Modulation	ASK

Table 9.11 Impella Connect® Wi-Fi Transmitter / Receiver Specifications

IEEE Protocols	802.11a, 802.11b, 802.11g, and 802.11n			
Receiver bandwidth	120 MHz/ 40 MHz			
Effective radiated power	<0.071 watts			
Frequency Bands	2412 MHz to 2462 MHz US			
	2412 MHz to 2472 MHz EU			
	2412 MHz to 2684 MHz JP			
	5180 MHz to 5825 MHz US 5180 MHz to 5700 MHz EU 5180 MHz to 5700 MHz JP			
IEEE	802.11a	802.11b	802.11g	802.11n
Modulation	OFDM	D5.55	OFDM	MxMO OFMD
Video Frame Rate	20 fps (Maximum)			
Data Rate	512 Kbps (Average)			
Certified Wi-Fi Module				
Manufacturer:	Texas Instruments			
Part number:	WL18MODGI			
FCC ID:	Z64-WL18DBMOD			

VGA MONITOR CONNECTION

The Automated Impella Controller, which is equipped with a VGA output connector, can be connected to a remote monitor to display the information from the controller to another screen at a resolution of 800 x 600 pixels. The connection between the controller and the monitor can be made using a cable up to 20 feet in length. If the AIC has the optional Impella Connect MDDS attached, the VGA Output connector is located on the back of the Impella Connect. The Impella Connect can be used to transfer the video stream from the AIC to a remote viewing location (via the internet).

The communication between the Impella Connect and the AIC is one-way. The streamed video data is limited to Impella device operating parameters and alarms messages. There is no patient identifiable information on any of the AIC screens. The Impella Connect will have to be configured by the hospital's IT department to access approved wireless networks. The video stream displayed via the Impella Connect web app enables remote patient monitoring by providing authorized users with passive viewing of the AIC's display which includes information on alarms and hemodynamic data useful for troubleshooting and managing Impella devices to aid in patient management.



During use with the Impella Connect[®], a Medical Device Data System (MDDS), if the Automated Impella Controller is exposed to strong electromagnetic disturbances, the Impella Connect may either restart or shut down. Operators should be aware that, under these conditions, the Automated Impella Controller operating parameters are not affected.



Do not insert any unauthorized devices into the USB port. This includes chargers, memory sticks, wireless dongles and other unauthorized devices.

ALARM DELAY INFORMATION

For some Automated Impella Controller alarms, there is a short delay between the triggered event and the audible annunciation and visual display of the alarm.

Table 9.12 Alarm Delay Information

Impella Defective	8 second delay
Impella Position Wrong	11±5 second delay
Controller Error	12±3 second delay
Emergency Shutdown Imminent	15±1 second delay
Battery Failure	28±8 second delay
Controller Failure	38±8 second delay
Battery Comm. Failure	40±10 second delay
Purge System Blocked	75±45 second delay

PATIENT ENVIRONMENT

The Automated Impella Controller and the components of the Impella Ventricular Support Systems are approved for use within the patient environment defined in IEC 60601-1: 3rd edition and in the figure below.

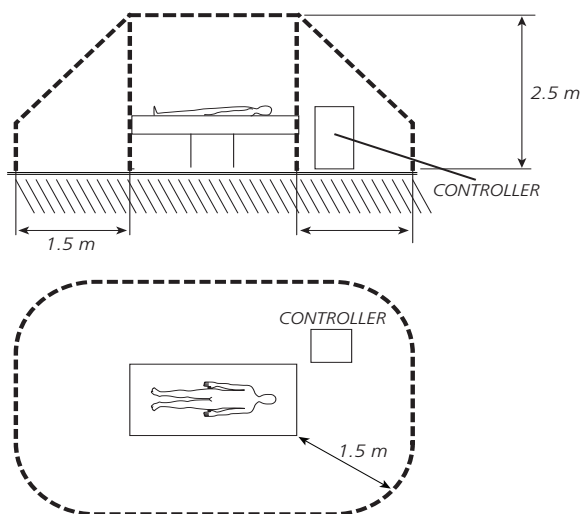

Figure 9.1 Automated Impella Controller Patient Environment

USE ENVIRONMENT

The Automated Impella Controller system is suitable for use in hospital and transport environments. For additional detail, please refer to section 2.1 and section 9.

IMPELLA CATHETER PARAMETERS

Table 9.13 Impella 5.5 with SmartAssist Catheter Parameters

Speed Range	0 to 33,000 rpm
Power Consumption	Less than 16 W
Voltage	Max. 20 V DC
Flow-Maximum	5.5 L/min
Purging the Impella 5.5 Catheter	
Recommended purge fluid	5% dextrose solution with heparin concentrate of 25 or 50 IU per mL
Dextrose concentration	5% to 20%
Purge Pressure	300 to 1100 mmHg
Purge Flow	2 to 28 mL/hr
Maximum duration of use	
US	Up to 14 days
EU	Up to 30 days
Dimensions of Impella 5.5 Catheter	
Length of invasive portion (without catheter)	114 mm
Diameter (Motor)	19 Fr (6.3 mm)
Diameter (Cannula)	21 Fr (7 mm)
Classification per DIN EN 60601-1	Protection class I, degree of protection: CF (Automated Impella Controller and Impella 5.5 Catheter)
Classification per directive 93/42/EEC	Class III
Latex Free	Yes

Weaning the patient from the Impella Catheter is at the discretion of the physician. The Impella 5.5 with SmartAssist Systems have been approved for ≤ 14 days. However, weaning could be delayed beyond the normal use for temporary support as an unintended consequence of continued instability of the patient's hemodynamics. Inability to wean the patient from the device within a reasonable time frame should result in consideration of a more durable form of left ventricular support.

TECHNICAL SPECIFICATIONS

Table 9.14 Impella 5.5 with SmartAssist Pump Metrics

Impella Pump Metric	Range	Accuracy ¹
Pump Outlet (Aortic) Pressure	0 to 200 mmHg	1.9 mmHg
Pump Inlet (Left Ventricular) Pressure	0 to 200 mmHg	8.8 mmHg
Pulse Pressure	0 to 100 mmHg	2.5 mmHg
Native Cardiac Output	0 to 5.0 L/min	0.6 L/min
Cardiac Power Output	0 to 3.0 Watts	0.2 Watts
*the measured root mean square error ¹ (of multiple measurements)		

¹ Metric accuracy determined in vitro. Data on file at Abiomed, available upon request.

IMPELLA 5.5 WITH SMARTASSIST CATHETER DIMENSIONS

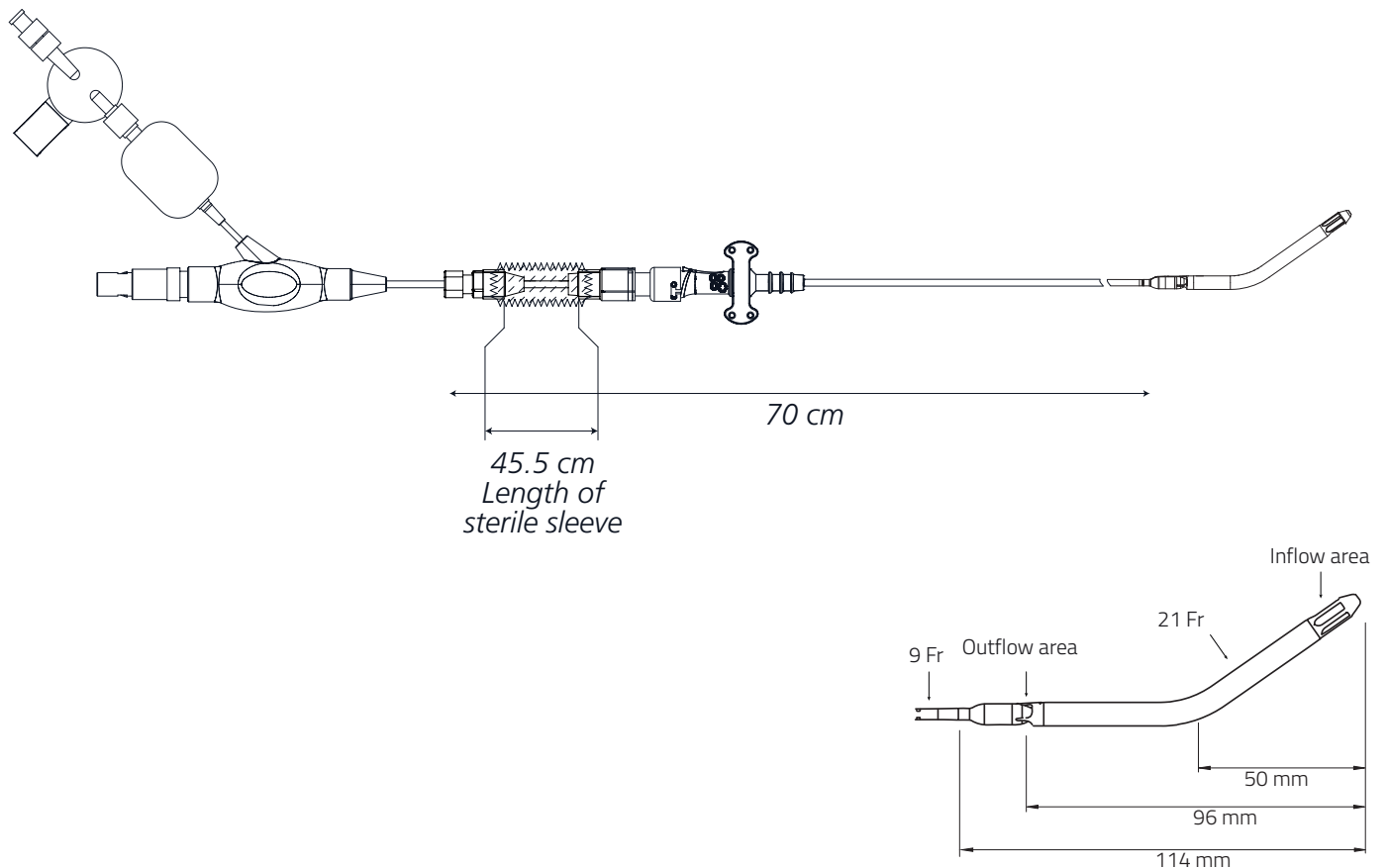

Figure 9.2 Impella 5.5 with SmartAssist Catheter Dimensions

Alcohol Warning

Do NOT clean the Impella Catheter infusion filter or pressure reservoir with alcohol and AVOID exposing these components to products containing alcohol.

Storing the Controller

To keep the Automated Impella Controller battery charged, the controller should be plugged into an AC outlet. When plugged into an AC outlet, the controller battery will charge whether the controller is on or off.

CLEANING

- Clean the Automated Impella Controller keypad and display with either 70% isopropyl alcohol or soap and water. (NOTE: Be aware that soft buttons may be activated when you spray or wipe the display.)
- Clean the Automated Impella Controller housing with mild detergent.
- Do NOT clean with or expose any part of the clear sidearm of the Impella Catheter (e.g., infusion filter, pressure reservoir) to alcohol. Alcohol has been shown to cause cracks and leaks in these components. Carefully read labels on common skin preps and lotions to avoid using any alcohol-containing products in the area of the infusion filter or pressure reservoir.
- Do NOT allow any fluids to enter the connector sockets.
- Clean the connector cable with 70% isopropyl alcohol.

STORING THE AUTOMATED IMPELLA CONTROLLER



The Li-Ion batteries must be charged for 5 hours prior to system operation in order to meet the runtime requirement of 1 hour. Failure to do so will yield a shorter runtime. After being unplugged, the Automated Impella Controller will operate for at least 60 minutes after the batteries have been fully charged.

- Place the Automated Impella Controller on a horizontal surface to prevent falling.
- Connect the AC power cord to an AC outlet.
- The battery may be destroyed if the Automated Impella Controller is stored with a depleted battery.

RETURNING AN IMPELLA CATHETER TO ABIOMED (UNITED STATES)

To return an Impella Catheter to Abiomed, contact your local Clinical Consultant for an Abiomed-approved return kit.* The kit includes instructions for returning the Impella Catheter to Abiomed.

** Only available in the United States*

Page intentionally left blank

APPENDICES



APPENDIX A: IMPELLA VENTRICULAR SUPPORT SYSTEMS LIMITED SERVICE WARRANTY (UNITED STATES)	A.1
---	------------

APPENDIX B: AUTOMATED IMPELLA CONTROLLER MENU STRUCTURE.....	B.1
---	------------

Overview	B.1
Mute Alarm	B.1
Flow Control.....	B.1
Display	B.2
Purge Menu.....	B.2
Menu	B.3

APPENDIX A: IMPELLA VENTRICULAR SUPPORT SYSTEMS LIMITED SERVICE WARRANTY (UNITED STATES)

Abiomed®, Inc. warrants that, at the time of installation, all Impella Ventricular Support Systems (the “Goods”) sold will be free from defects in material and workmanship and remain free from defects under normal use and service for a period of one (1) year from the date of shipment. Extended warranty and service may, at Abiomed's option, be offered for an additional charge, in which event separate or additional terms and conditions may apply. This warranty provides coverage for the Automated Impella Controller.

This warranty does not cover routine preventative maintenance or replacement parts that are consumed per the controller's periodic maintenance schedule outlined in the Operator's and Service Manuals.

The express warranty set forth on this page is the only warranty given by Abiomed with respect to any goods furnished hereunder. Abiomed makes no other warranty, express, implied or arising by custom or trade usage, and specifically makes no warranty of merchantability or of fitness for any particular purpose. Said express warranty shall not be enlarged or otherwise affected by Abiomed's rendering of technical or other advice or service in connection with the Goods.

Abiomed shall not be liable for incidental or consequential losses, damages or expenses, directly or indirectly arising from the sale, handling or use of the Goods, or from any other cause relating thereto, and Abiomed's sole responsibility under this warranty will be, at its option, to 1) repair or replace the Goods or any components of the Goods found to be defective in workmanship or material during the foregoing warranty period, or 2) to refund the purchase price paid. All replaced components and Goods will become the property of Abiomed. This warranty shall not apply if the Goods have been: (a) repaired or altered in any way by other than Abiomed or Abiomed authorized service personnel; (b) subjected to physical or electrical abuse or misuse; or (c) operated in a manner inconsistent with Abiomed's instructions for use of the Goods. If Abiomed determines that a claim was not caused by Abiomed or Abiomed's authorized service personnel, then Buyer shall pay Abiomed for all related costs incurred by Abiomed. This warranty is not transferable without the express written consent of Abiomed.

Under this warranty, Abiomed will provide at no charge, updates or modifications which directly affect the safe operation of the Goods. Abiomed is not obligated to provide updates or modifications which provide (a) product improvement or enhancement; (b) new product features, or (c) options to the Goods.

Abiomed has no obligation to provide a loaner system during service or maintenance of the Goods. However, at Abiomed's sole discretion, Abiomed may provide such loaner systems.

This warranty applies to the Automated Impella Controller and not to any disposable or other component of the Impella System. Specific items excluded from this warranty include, but are not limited to, pumps, external tubing, and accessories.

This warranty may not be amended without the express written consent of an authorized officer of Abiomed.

APPENDIX B: AUTOMATED IMPELLA CONTROLLER™ MENU STRUCTURE

OVERVIEW

The soft buttons on the Automated Impella Controller provide access to the controller menu structure. The menu structure has 5 main elements:

- MUTE ALARM
- FLOW CONTROL
- DISPLAY
- PURGE MENU
- MENU

This Appendix provides an overview of the Automated Impella Controller menu structure. Many of the functions accessed through this menu structure are also discussed elsewhere in this manual.

MUTE ALARM

The **MUTE ALARM** soft button mutes (silences) active alarms. It does not open another menu.

When you press **MUTE ALARM**, a bell icon with an X through it replaces the words "MUTE ALARM" in the upper right of the display screen. If no alarms are active, no bell icon is displayed. When you press **MUTE ALARM** it acknowledges all active alarms and silences the audible alarm indicator for 2 minutes (for red or yellow alarms) or 5 minutes (for white alarms). (Refer to section 8 of this manual for more information about Automated Impella Controller alarms.)

FLOW CONTROL

The **FLOW CONTROL** soft button opens the **FLOW CONTROL** menus. Before the Impella Catheter is started, the menu options include **OFF** and **Start Pump**. For the Impella 5.5 with SmartAssist, Menu options include P-levels between P-0 and P-9 as shown in section 5 in this manual. The procedure for setting P-level is described in "Positioning and Starting the Impella Catheter" in section 5.

DISPLAY

The **DISPLAY** soft button opens a menu that includes the following options for viewing waveforms and navigating to other screen displays:

- **Y-axis Scale** – opens a menu from which you can select a waveform and change its appearance by adjusting the scale of the y-axis.
 - Once the waveform is selected, turn the selector knob clockwise to increase the y-axis scale and counterclockwise to decrease the y-axis scale.
 - Select **OK** to accept the new y-axis scale.
 - Select **Restore Default** to return to the default y-axis scale.
 - Select **Center Signal** to center the waveform.
 - Select **Cancel** to exit the tool.
- **Time Scale** – allows you to apply different time scales to the currently displayed waveforms.
- **Disable/Enable LV Signal** - allows you to disable the LV waveform temporarily. Same option is selected to re-enable waveform.
- **Center Motor Current** – automatically centers the motor current waveform and adjusts the range accordingly.
- **Infusion** – opens the Infusion History screen. The Infusion History screen, which is discussed in section 4 of this manual, shows the volume and amount of heparin and dextrose delivered. The top entry in the table shows the volume and amount of heparin and dextrose infused from the top of the hour through the current time.
- **Purge** – displays the purge system waveforms and pressure and flow values.
- **LVEDP Trend** - displays trend information for mean aortic pressure and estimated left ventricular end-diastolic pressure (LVEDP) and Impella Flow
- **Placement** – opens the placement signal / motor current placement screen (described in section 4 under “Placement Screen”).
- **Home** – opens the home screen (described in section 4 under “Home Screen”).

PURGE MENU

The **PURGE MENU** soft button opens a menu that includes the following purge system procedure options:

- **Change Purge Fluid Bag** – starts the procedure to change the purge fluid
- **Change Purge Cassette & Bag** – starts the procedure to change both the purge fluid and purge cassette
- **De-air Purge System** – starts the de-air procedure

These procedures are described in section 5 of this manual.

MENU

The **MENU** soft button opens a menu of options related to controller settings, alarm history, repositioning, and starting a procedure. The menu includes the following options:

- **Settings / Service**

Service

System Information. Opens the System Information table. This provides information about the software version, IP addresses, current type of Impella Catheter, and current catheter runtime.

USB Data Download. When no pump is connected, this display appears for downloading data logs to a USB device

Metrics Display - Allows you to disable metrics or enable advanced metrics using a designated code.

Set Date/Time. Displays the menu for changing the date and time

Service Timers. Displays the Service Timers menu. Console operating time and purge motor operating time are displayed in hours.

Optical Bench Service - When no pump is connected, this display appears for console information. Used by Abiomed personnel only.

Screen Brightness. Opens the Screen Brightness selection box. The brightness of the screen display can be set from 50% to 100%.

Language. When the software supports multi-language, this opens the Language selection box. Use the selector knob to select language. The system will immediately change the language on the controller for all displayed text. This language will be used after system restart unless another language is selected.

Disable (Enable) Placement Monitoring. Allows you to disable or enable Placement Monitoring and the annunciation of all position alarms. This selection is available whenever the Impella Catheter is connected.

Disable (Enable) Audio –Placement Signal Not Reliable. Allows you to enable or disable audio for the Placement Signal Not Reliable alarm. This selection is available only if a Placement Signal Not Reliable alarm is active or the audio has been disabled for this alarm.

Disable (Enable) Audio –Purge Pressure High/System Blocked. Allows you to enable or disable audio for the Purge Pressure High or Purge System Blocked alarms. This selection is only available if one of these two alarms is active or the audio has been disabled for one of these alarms.

Disable (Enable) Audio - Suction. Allows you to enable or disable audio for Suction alarms. This selection is available only if a Suction alarm is active or the audio has been disabled for this alarm.

Disable (Enable) Audio - Placement Signal Low. Allows you to enable or disable audio for Placement Signal Low alarm.

Disable (Enable) Retrograde Flow Control. If the Impella Catheter minimum flow is below 0.1 L/min then the controller will increase the motor speed to prevent retrograde flow. This menu selection can be used to disable Retrograde Flow Control during weaning. This selection is available whenever the Impella Catheter is connected.

Enable (Disable) Purge Flow Change Notification. Allows you to enable or disable the purge flow notification white alarms ("Purge Flow Increased" and "Purge Flow Decreased").

Enable (Disable) Surgical Mode. Allows you to enable or disable Surgical Mode. If Surgical Mode is enabled, the "Impella Stopped" alarm is silenced at P-0.

- **Adjust LV Signal** – Allows you to calibrate the LV Placement Signal
- **Alarm History** – Opens the Alarm History table. This provides a visual display of the chronology of stored alarm messages. The most recently occurring alarm message is displayed at the top of the list. For each message, the date and time it occurred and the alarm message heading is displayed. You can use the selector knob to select individual alarm messages and an explanation for the selected alarm message will be displayed in the failure description box.
- **Enter Cardiac Output** – Allows you to calibrate the LV Placement Signal
- **Case Start** – begins the case procedure. Case Start is described in section 5 of this manual under "Case Start."
- **Repositioning Guide** – opens the Repositioning guide to step through repositioning without imaging for "Impella Position In Ventricle" scenarios
- **Start Data Snapshot** – starts the timed data recording function to save real-time operating data for later analysis. Timed Data Recording is described under "Timed Data Recording" in section 7 of this manual.



Clinical support 24 hours per day, 7 days a week:

1-800-422-8666 (US)

+49 (0) 1805 2246633 (EU)

www.abiomed.com

Abiomed, Inc.
22 Cherry Hill Drive
Danvers, Massachusetts 01923 USA
Voice: 978-777-5410
Facsimile: 978-777-8411
Email: clinical@abiomed.com

Abiomed Europe GmbH
Neuenhofer Weg 3
52074 Aachen, Germany
Voice: +49 (0) 241 8860-0
Facsimile: +49 (0) 241 8860-111
Email: europe@abiomed.com