

**OFFICE OF CLINICAL PHARMACOLOGY AND BIOPHARMACEUTICS  
REVIEW**

---

NDA: 20-632 (b) (4) 021	Submission Date(s): 21 June 2004 and November 4, 2004
Brand Name	Meridia®
Generic Name	Sibutramine hydrochloride monohydrate capsules
Reviewer	Wei Qiu, Ph.D.
Team Leader	Hae-Young Ahn, Ph.D.
OCPB Division	DPEII
ORM division	Metabolic and Endocrine Drug Products
Sponsor	Abbott Laboratories
Relevant IND(s)	(b) (4)
Submission Type	Prior Approval Supplement: Pediatric Exclusivity and Labeling
Formulation; Strength(s)	Capsule; 5, 10, and 15 mg
Indication	Obesity

---

## Table of Contents

1	Executive Summary.....	2
1.1	Recommendation .....	2
1.2	Phase IV Commitments .....	2
1.3	Summary of Clinical Pharmacology and Biopharmaceutics Findings .....	2
2	Question Based Review.....	3
2.1	General Attributes of the Drug.....	3
2.2	General Clinical Pharmacology .....	3
2.3	Intrinsic Factors .....	3
2.4	Extrinsic Factors .....	9
2.5	General Biopharmaceutics.....	9
2.6	Analytical Section .....	9
3	Detailed Labeling Recommendations.....	10
4	Appendix .....	10
4.1	Cover Sheet and OCPB Filing/Review Form .....	10
4.2	Individual Study Synopsis .....	13

# 1 Executive Summary

## 1.1 Recommendation

The Office of Clinical Pharmacology and Biopharmaceutics/Division of Pharmaceutical Evaluation 2 (OCPB/DPE-2) has reviewed NDA 20-632 (b) (4) 021 submitted on 21 June 2004 and November 4, 2004, and finds it acceptable regarding the similarity of sibutramine pharmacokinetics in obese adolescents and adults via cross-study comparison. Recommendation, comments, and labeling comments should be conveyed to the sponsor as appropriate.

**Comments:** Related to cardiac safety issues, it may be worth noting that the potential for QT prolongation for sibutramine has not been studied in a prospective QT prolongation study.

CPB Briefing was held on November 30, 2004.

Attendees: Henry Malinowski, John Hunt, Hae-Young Ahn, Shiew-Mei Huang, John Lazor, Nam Atiqur Rahman, He Sun, Leslie Kenna, and Wei Qiu.

## 1.2 Phase IV Commitments

Not applicable.

## 1.3 Summary of Clinical Pharmacology and Biopharmaceutics Findings

The studies performed have met the Written Request and pediatric exclusivity is granted.

In Written Request Amendment #2 dated Dec. 17, 2003, the study design was stated as "A pharmacokinetic study at doses of 10 mg and 15 mg should be conducted in 12 to 16 year old obese adolescents. This study can be conducted as an appropriate subset of the clinical study using sparse sampling, or as a conventional single-dose pharmacokinetic study supplemented with additional data (trough plasma concentrations at steady-state) in a large group of subjects within a clinical efficacy study." Under study evaluations, it was indicated that "Relevant pharmacokinetic parameters for sibutramine and its active metabolites should be calculated. Tanner stages for the patients in the pharmacokinetic study must be recorded and provided in the study report".

The sponsor conducted a conventional single dose (15 mg) pharmacokinetic study in 12 to 16 year old obese adolescents (Study SB240) and provided trough plasma concentrations at steady-state in a subset of 91 patients within a clinical efficacy trial (Study SB238). The sponsor calculated pharmacokinetic parameters for sibutramine and its active metabolites M1 and M2. Tanner states for the patients in the PK study was recorded and provided in the submission.

Following the oral administration of a single dose of 15 mg sibutramine in obese adolescents, sibutramine was rapidly absorbed with  $T_{max}$  of 1.3 hours and underwent extensive first-pass metabolism with CL/F of 2071 L/h. Sibutramine was rapidly eliminated with a half-life of 1.6 hours. The active metabolites M1 and M2 were formed rapidly with  $T_{max}$  of approximately 3 hours. The harmonic mean half-lives of M1 and M2 were 5.2 and 13.4 hours, respectively. The geometric means for  $C_{max}$  and  $AUC_{0-t}$  of M1 in obese adolescents were 3.22 ng/mL and 22.1 ng.h/mL, respectively. The geometric means for  $C_{max}$  and  $AUC_{0-inf}$  of M2 in obese adolescents were 6.19 ng/mL and 90.5 ng.h/mL, respectively. The geometric means for  $C_{max}$  and  $AUC_{0-t}$  of M1 in obese adults obtained from previous study SB3813 were 3.68 ng/mL and 21.2 ng.h/mL, respectively. The geometric means for  $C_{max}$  and  $AUC_{0-inf}$  of M2 in obese adults were 6.12 ng/mL and 89.4 ng.h/mL, respectively. Crossover study comparison (SB240 in adolescents and SB3813 in adults)

suggested that the exposure of active metabolites M1 and M2 were similar between obese adolescents and obese adults.

For the 10 mg dose, trough concentrations of sibutramine, M1 and M2 were  $0.083 \pm 0.287$ ,  $0.749 \pm 0.896$ , and  $1.95 \pm 0.876$  ng/mL, respectively (Study SB238). The trough concentrations of M1 and M2 obtained from a previous study in adults (Study BPI852) were  $0.343 \pm 0.584$  and  $1.560 \pm 1.043$  ng/mL, respectively. For the 15 mg dose, trough concentrations of sibutramine, M1 and M2 in obese adolescents were  $0.118 \pm 0.263$ ,  $0.918 \pm 0.790$ , and  $2.534 \pm 1.521$  ng/mL, respectively. Trough concentrations of M1 and M2 in obese adults were  $1.086 \pm 1.233$  and  $3.167 \pm 2.069$  ng/mL, respectively. Sibutramine trough concentrations in adults were not determined. Statistically analysis suggested that M1 and M2 trough concentrations were not different between obese adolescents and adults. The results were consistent with the comparison of single dose pharmacokinetics.

## 2 Question Based Review

### 2.1 General Attributes of the Drug

Not applicable.

### 2.2 General Clinical Pharmacology

Not applicable.

### 2.3 Intrinsic Factors

#### 1. Does age influence exposure?

Cross study comparison of a single dose (15 mg) pharmacokinetics in obese adolescents (Study SB240) and obese adults (Study SB3813) showed similar exposure in adolescents and adults. Cross study comparison of trough levels of multiple doses of 10 mg or 15 mg dose in obese adolescents (Study SB238) and obese adults (Study BPI852) suggested similar trough concentrations in obese adolescents and adults.

#### Single Dose:

Single-dose pharmacokinetics of sibutramine and its metabolites in 18 obese adolescents (age 12 to 16 years) were assessed in Study SB240. Subjects were given a single dose of 15 mg sibutramine orally. Blood samples were collected up to 72 hours after drug administration. The concentration-time profiles of sibutramine (**Figure 1**), M1 (**Figure 2**) and M2 (**Figure 3**) are presented. The results of pharmacokinetic parameters are summarized in **Table 1**.

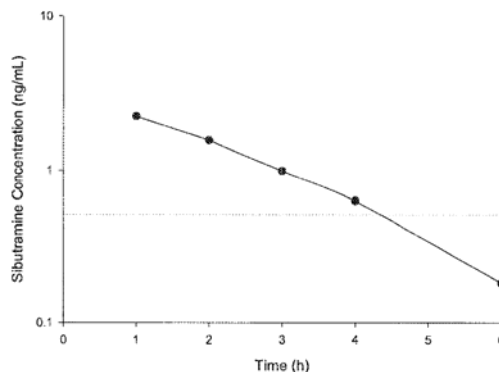

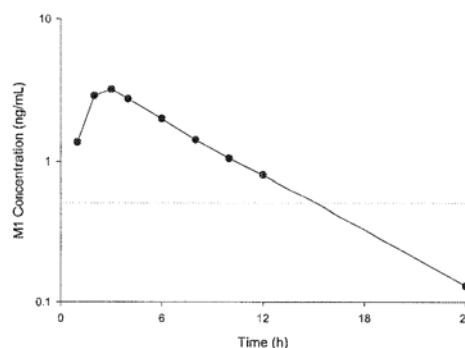
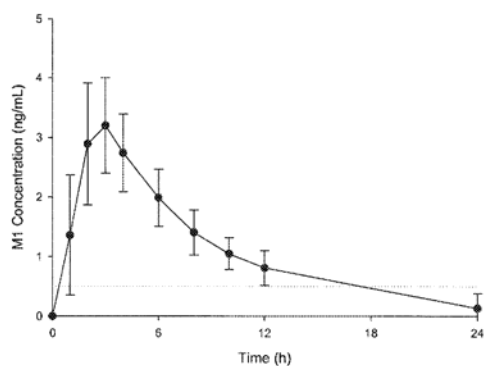
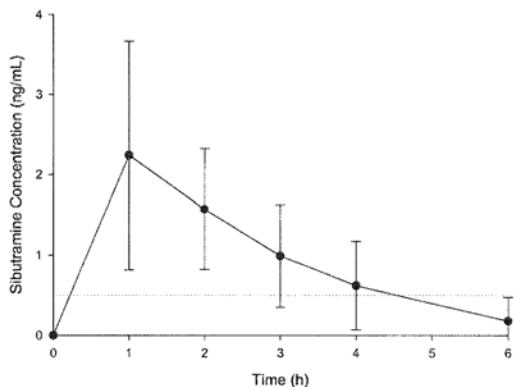

**Figure 1.** Mean sibutramine plasma concentration-time profiles, Linear scale (Left panel, with SD) and log-linear scale (right panel, without SD).

**Figure 2.** Mean M1 plasma concentration-time profiles, linear scale (left panel, with SD) and log-linear scale (right panel, without SD).

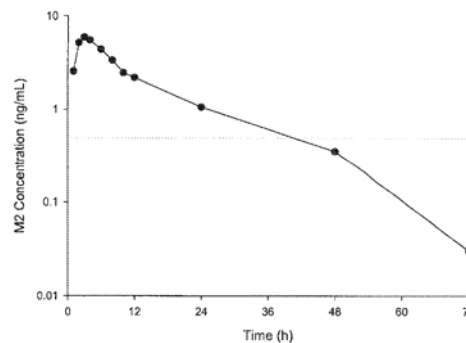
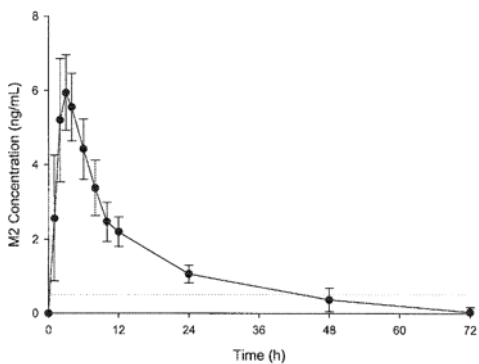

**Figure 3.** Mean M2 plasma concentration-time profiles, linear scale (left panel, with SD) and log-linear scale (right panel, without SD)

**Table 1.** Mean  $\pm$  SD pharmacokinetic parameters of sibutramine and its metabolites after a single 15 mg oral dose of sibutramine (Mean  $\pm$  SD age of  $13.8 \pm 1.5$  years, BMI of  $33.9 \pm 3.6$  kg/m<sup>2</sup>, N=18) administered 30 minutes prior to a meal

Pharmacokinetic Parameters (units)	Sibutramine	M1	M2	M5	M6
T <sub>max</sub> (h)	1.3 ± 0.8	2.9 ± 1.0	3.2 ± 1.3	2.7 ± 0.8	3.4 ± 1.5
C <sub>max</sub> (ng/mL)	2.43 ± 1.20	3.33 ± 0.84	6.27 ± 1.00	13.4 ± 3.6	12.0 ± 2.7
AUC <sub>0-T</sub> (ng•h/mL)	5.42 ± 2.76	23.4 ± 8.64	77.0 ± 20.3	145 ± 51	208 ± 61
AUC <sub>0-∞</sub> (ng•h/mL)	7.58 ± 2.91	30.4 ± 10.8	93.0 ± 23.1	192 ± 63	242 ± 62
t <sub>1/2</sub> <sup>S</sup> (h)	1.61 ± 0.81 <sup>#</sup>	5.21 ± 2.54	13.4 ± 7.2	11.3 ± 6.6	14.6 ± 8.3
CL/F (L/h)	2071 ± 1108	--	--	--	--
V/F (L)	5406 ± 2962	--	--	--	--

<sup>S</sup> Harmonic mean ± pseudo-standard deviation.

<sup>#</sup> N=14.

Following the administration of a single 15 mg oral dose of sibutramine in obese adolescents, sibutramine was rapidly absorbed with T<sub>max</sub> of 1.3 hours and underwent extensive first-pass metabolism with CL/F of 2071 L/h. The two pharmacologically active metabolites M1 and M2 had higher exposure and longer half-lives than the parent drug sibutramine. The elimination of M1 and M2 appeared to follow mono-exponential and bi-exponential decay, respectively. The secondary glucuronide conjugates M5 and M6, pharmacologically inactive, had higher exposure than sibutramine, M1 and M2.

The pharmacokinetics of the 15 mg single dose sibutramine in obese adolescents were compared with those of obese adults obtained from a previous study SB3813. These two studies had similar population demographics in terms of BMI (33.9 ± 3.6 kg/m<sup>2</sup> in SB240 and 33.6 ± 3.0 kg/m<sup>2</sup> in SB3813) and sex (10 males and 8 females in SB240 and 12 males and 6 females in SB3813); race distribution was somewhat different between these studies (11 Caucasian and others in SB240 and 18 Caucasian in SB3813). The results of statistical comparison (**Table 2**) indicated that the exposure of active metabolites M1 and M2 were similar between obese adolescents and obese adults. The exposure of M5 and M6 in obese adolescents was approximately 53 to 74% of that in obese adults; however, the t<sub>1/2</sub> was similar between the two populations. Sibutramine exposure was not compared because very few samples had measurable sibutramine concentrations in adults due to a high Limit Of Quantification (LOQ) (10 ng/mL) in Study SB3813. The LOQ for sibutramine in Study SB240 is 0.5 ng/mL.

**Table 2.** Statistical comparison between SB240 and SB3813 (a single 15 mg oral dose of sibutramine in obese adults, mean ± SD age=37 ± 11 yr, BMI=33.6 ± 3.0 kg/m<sup>2</sup>, N=18)

Pharmacokinetic Parameter	Central Values*		Ratio of Central Values	95% Confidence Interval	p-value	
	Obese Adolescents (SB240)	Obese Adults (SB3813)				
M1	C <sub>max</sub>	3.22	3.68	0.88	0.69 – 1.11	0.264
	AUC <sub>0-T</sub> <sup>#</sup>	22.1	21.2	1.05	0.74 – 1.47	0.792
	T <sub>max</sub>	2.89	3.58	--	--	0.051
M2	C <sub>max</sub>	6.19	6.12	1.01	0.86 – 1.18	0.896
	AUC <sub>0-∞</sub>	90.5	89.4	1.01	0.86 – 1.19	0.880
	T <sub>max</sub>	3.22	3.53	--	--	0.354
M5	C <sub>max</sub>	12.94	24.53	0.53	0.44 – 0.63	<0.001 <sup>+</sup>
	AUC <sub>0-∞</sub>	183.1	261.6	0.70	0.58 – 0.85	0.001 <sup>+</sup>
	T <sub>max</sub>	2.72	3.06	--	--	0.173
M6	C <sub>max</sub>	11.7	20.2	0.58	0.47 – 0.71	<0.001 <sup>+</sup>
	AUC <sub>0-∞</sub>	233.5	315.4	0.74	0.61 – 0.90	0.004 <sup>+</sup>
	T <sub>max</sub>	3.44	3.22	--	--	0.573

\* Geometric means for C<sub>max</sub>, AUC<sub>0-T</sub>, and AUC<sub>0-∞</sub>; arithmetic mean for T<sub>max</sub>.

# t<sub>1/2</sub> for M1 was not estimable for SB3813; therefore, AUC<sub>0-T</sub> of M1 was used for the comparison between the two studies instead of AUC<sub>0-∞</sub>.

+ Statistically significant (p ≤ 0.05).

In SB3813, very few samples had measurable sibutramine concentrations, with LOQ being 10 ng/mL. A cross-study comparison for sibutramine, therefore, was not carried out.

The Tanner scores for obese adolescents in Study SB240 are shown in **Table 3**.

**Table 3. Tanner Score of Pubertal Development**

Tanner score*	1	2	3	4	5
Number (%) subjects with Tanner score	3 (16.7%)	1 (5.6%)	5 (27.8%)	4 (22.2%)	5 (27.8%)

\* The 18 subjects in this study had the same values for the two components defining the Tanner score (genitals and pubic hair for males, genitals and breasts for females)

### Multiple Dose:

Trough concentrations of active metabolites M1 and M2 following multiple dose administration of 10 or 15 mg sibutramine were assessed in obese adolescents in Study SB238. A total of 368 patients were dosed with sibutramine. All patients in sibutramine group remained on a 10 mg daily dose for the first 6 months. At 6 months, all of the patients on sibutramine who had not lost >10% of their initial BMI were up-titrated to 15 mg daily for the rest of the study. Trough plasma concentrations of sibutramine, M1 and M2 were measured in a subset of 91 patients at Months 8, 9 and 10 using a LC-MS method. The LOQ for all three compounds was 0.5 ng/mL. Most of the sibutramine concentrations measured were below the LOQ (0.5 ng/mL). Results are presented in **Table 4**.

**Table 4.** Mean  $\pm$  SD and Median Trough Concentrations of Sibutramine, M1, and M2 in 91 Adolescent Subjects Receiving 10 or 15 mg of Sibutramine QD (SB238)

	Adolescent Subjects					
	Month 8		Month 9		Month 10	
	Mean $\pm$ SD	Median*	Mean $\pm$ SD	Median*	Mean $\pm$ SD	Median*
<b>Sibutramine 10 mg QD</b>						
N	33		37		36	
Sibutramine	0.213 $\pm$ 0.633	0.000	0.284 $\pm$ 0.874	0.000	0.082 $\pm$ 0.245	0.000
M1	0.896 $\pm$ 1.056	0.701	1.008 $\pm$ 1.224	0.824	0.730 $\pm$ 0.810	0.587
M2	2.339 $\pm$ 1.477	2.161	2.401 $\pm$ 1.547	1.833	2.019 $\pm$ 1.187	1.844
<b>Sibutramine 15 mg QD</b>						
N	50		52		48	
Sibutramine	0.527 $\pm$ 0.953	0.000	0.493 $\pm$ 1.079	0.000	0.373 $\pm$ 0.926	0.000
M1	1.175 $\pm$ 1.061	1.117	1.071 $\pm$ 1.270	0.849	1.048 $\pm$ 1.147	0.893
M2	2.837 $\pm$ 2.409	2.574	2.747 $\pm$ 2.861	2.154	2.886 $\pm$ 2.725	2.720

\* Concentrations < LOQ are designated as zero.

However, many blood samples were not collected 24 hours after the previous dose or no information on sampling time since last dose was available. Therefore, only concentrations of sibutramine, M1, and M2 obtained between 22 and 26 hours after the previous dose are presented in **Table 5**.

**Table 5.** Mean  $\pm$  SD and Median Trough Concentrations of Sibutramine, M1 and M2 in Adolescent Subjects Receiving 10 or 15 mg of Sibutramine QD with Plasma Samples Obtained 22 to 26 hours after previous Dose (SB238).

	Adolescent Subjects					
	Month 8		Month 9		Month 10	
	Mean $\pm$ SD	Median*	Mean $\pm$ SD	Median*	Mean $\pm$ SD	Median*
<b>Sibutramine 10 mg QD</b>						
N	19		20		19	
Sibutramine	0.118 $\pm$ 0.376	0.000	0.097 $\pm$ 0.314	0.000	0.048 $\pm$ 0.211	0.000
M1	0.817 $\pm$ 1.126	0.598	0.669 $\pm$ 0.507	0.676	0.630 $\pm$ 0.798	0.572
M2	2.028 $\pm$ 0.902	1.854	1.899 $\pm$ 0.842	1.691	1.780 $\pm$ 0.807	1.531
<b>Sibutramine 15 mg QD</b>						
N	19		19		16	
Sibutramine	0.174 $\pm$ 0.302	0.000	0.128 $\pm$ 0.311	0.000	0.050 $\pm$ 0.200	0.000
M1	1.049 $\pm$ 0.659	1.063	0.915 $\pm$ 1.008	0.849	0.776 $\pm$ 0.586	0.808
M2	2.593 $\pm$ 1.143	2.755	2.643 $\pm$ 2.282	2.437	2.529 $\pm$ 1.545	2.724

\* Concentrations < LOQ are designated as zero.

The trough concentrations of M1 and M2 in obese adolescents at 10 and 15 mg doses were compared with those obtained from obese adults participating in a previous study BPI852. In Study BPI852, trough plasma samples were collected at Months 3 and 6. Plasma samples were

analyzed for concentrations of M1 and M2 using a LC-MS method. Concentration data from a total of 228 subjects receiving either 10 (N=116) or 15 mg (N=114) of sibutramine once daily were utilized in the comparison. These two studies had similar population demographics in terms of BMI ( $33.4 \pm 4.5$  kg/m<sup>2</sup> in SB238 and  $32.4 \pm 3.1$  kg/m<sup>2</sup> in BPI852). Gender distribution was different (40% male in SB238 and 18% male in BPI852).

The median of the trough values over all months for each subject was taken as a composite value, after showing no significant impact of the Month on M1 and M2 concentrations for either study. The mean  $\pm$  SD (median) of these composite values were calculated and shown in **Table 6**. The data from all collected samples and from samples obtained 22 to 26 hours after last dose are presented.

**Table 6.** Mean  $\pm$  SD (median) of Sibutramine, M1, and M2 Composite Plasma Trough Concentrations in Adolescent Subjects (Study SB238) and Adult Subjects (Study BPI852) after Sibutramine 10 or 15 mg QD

	10 mg Dose Group		15 mg Dose Group	
	Adolescents (SB238)	Adults (BPI852)	Adolescents (SB238)	Adults (BPI852)
<b>All Samples</b>				
N	37	116	54	114
Sibutramine (ng/mL)	0.085 $\pm$ 0.305 (0.000)*	--	0.319 $\pm$ 0.624 (0.000)*	--
M1 (ng/mL)	0.808 $\pm$ 0.928 (0.694)	0.419 $\pm$ 0.674 (0.000)*	1.078 $\pm$ 1.045 (0.974)	1.025 $\pm$ 1.171 (0.754)
M2 (ng/mL)	2.158 $\pm$ 1.083 (2.048)	1.614 $\pm$ 1.067 (1.467)	2.835 $\pm$ 2.531 (2.691)	2.960 $\pm$ 1.978 (2.720)
<b>Samples Obtained 22 to 26 hours after Last Dose</b>				
N	23	80	28	74
Sibutramine (ng/mL)	0.083 $\pm$ 0.287 (0.000)*	--	0.118 $\pm$ 0.263 (0.000)	--
M1 (ng/mL)	0.749 $\pm$ 0.896 (0.589)	0.343 $\pm$ 0.584 (0.000)*	0.918 $\pm$ 0.790 (0.915)	1.086 $\pm$ 1.233 (0.814)
M2 (ng/mL)	1.950 $\pm$ 0.876 (1.854)	1.560 $\pm$ 1.043 (1.300)	2.534 $\pm$ 1.521 (2.640)	3.167 $\pm$ 2.069 (2.863)

\* Concentrations < LOQ are designated as zero.

Statistically analyses suggested that M1 and M2 trough concentrations were not different between adolescents and adults for either 10 mg or 15 mg doses. As shown in **Table 6**, the variability of trough concentrations was large, especially for sibutramine and M1. The high variability is partially caused by the low concentrations close to the LOQ. The low concentrations are consistent with the short half-lives of sibutramine and M1.

**Population PK Analysis using NONMEM (This reviewer consulted with Dr. He Sun regarding population PK analysis):**

Additionally, the sponsor conducted a population pharmacokinetic analyses of the pharmacokinetic data for sibutramine, M1, and M2 after sibutramine 10 or 15 mg oral dosing in obese adolescents (Studies SB240 and SB238) and obese adults (Studies SB3813 and BPI852) using NONMEM. The five-compartment model with three exponential inter-individual random effects (ETAs) for K12, CL23, and CL30 is used as the base model. The final model includes the effect of sex and race on CL23, and BMI and sex on CL30. A combined additive and proportional residual variance model was used.



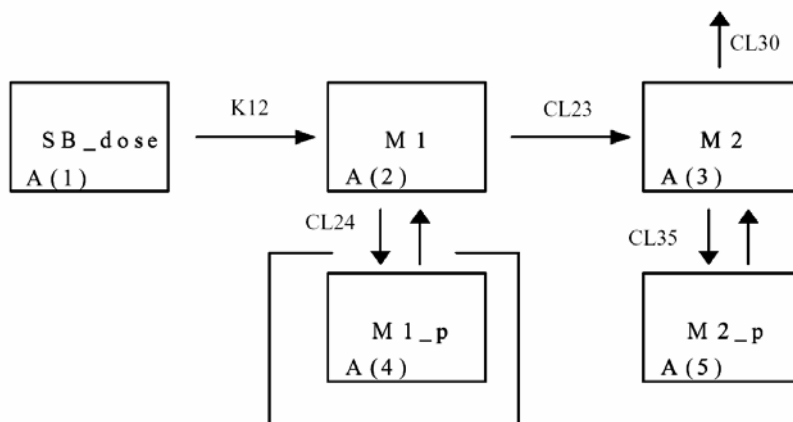

A(1): the amount of drug in the SB dose depot compartment  
 A(2): the amount of M1 in the central compartments  
 A(3): the amount of M2 in the central compartment  
 A(4): the amount of M1 in the peripheral compartment  
 A(5): the amount of M2 in the peripheral compartment

The results of the population PK analysis revealed that the elimination of M1 and M2 was not associated with age or growth related variables such as Tanner stage, suggesting that adolescents have similar exposures to the active metabolites compared to adults. This conclusion is consistent with the cross study comparison of single dose and multiple dose studies in adolescents and adults.

**Comments:** (1) The need of a peripheral compartment of M1 is in question based on the outcome of the parameters and considering the monoexponential characteristics of C-Time profile from the single dose study. (2) The sponsors started the modeling process with the combination of both additive and proportional error model which might be the cause of the bias of Cmax predictions. A proportional error model alone should be tested before using a combination of error models. (3) The sponsor is advised to sequentially search covariates in the modeling building process in the future.

## 2.4 Extrinsic Factors

Not applicable.

## 2.5 General Biopharmaceutics

Not applicable.

## 2.6 Analytical Section

### 1. What bioanalytical methods are used to assess concentrations?

LC/MS/MS methods were used for the determination of sibutramine and two metabolites M1 and M2 and M5 and M6. The in-study calibration contained eight standards ranging from approximately 0.5 to 20 ng/mL for sibutramine, M1 and M2, and from 1 to 40 ng/mL for M5 and M6. Quality control samples had concentrations of 1.5, 6, and 15 ng/mL for sibutramine, M2 and M2, and 3, 12, and 30 ng/mL for M5 and M6. The %CV values for the accepted data were not more than 14.23%; the mean analytical recoveries ranged from 84 to 108% of their theoretical values.

### 3 Detailed Labeling Recommendations

Under CLINICAL PHARMACOLOGY, Pharmacokinetics, Special Populations:

*Adolescent:* In obese adolescents (12-16 years old) receiving either 10 or 15 mg daily doses of sibutramine, trough plasma concentrations of the active metabolites M<sub>1</sub> and M<sub>2</sub> were similar to those obtained in adult obese patients receiving either 10 or 15 mg daily doses of sibutramine.

The pharmacokinetics of sibutramine active metabolites, M<sub>1</sub> and M<sub>2</sub>, have been studied after a single 15 mg dose to obese adolescents (n=18) ranging in age from 12-16 years administered 30 minutes prior to a meal.

#### Mean (%CV) and 95% Confidence Intervals of Pharmacokinetic Parameters in Adolescents

(15 mg Single Dose, n=18)

	C <sub>max</sub> (ng/mL)	T <sub>max</sub> (h)	AUC <sub>0-∞</sub> (ng*h/mL)	T <sub>1/2</sub> (h)
<b>Metabolite M<sub>1</sub></b>	3.3 (25) 2.9 - 3.8	2.9 (35) 2.4 - 3.4	30.4 (36) 24.9 - 35.9	7.8 (60) 5.4 - 10.2
<b>Metabolite M<sub>2</sub></b>	6.3 (16) 5.7 - 6.8	3.2 (39) 2.6 - 3.9	92.3 (25) 80.7 - 104	15.9 (41) 12.5 - 19.2

*Pediatric:* The pharmacokinetics of sibutramine in pediatric patients less than 12 years old have not been studied.

### 4 Appendix

#### 4.1 Cover Sheet and OCPB Filing/Review Form

Office of Clinical Pharmacology and Biopharmaceutics  
New Drug Application Filing and Review Form

General Information About the Submission

Information		Information	
NDA Number	20-632	Brand Name	Meridia®
OCPB Division (I, II, III)	II	Generic Name	Sibutramine hydrochloride monohydrate
Medical Division	510	Drug Class	
OCPB Reviewer	Wei Qiu, Ph.D.	Indication(s)	Weight loss
OCPB Team Leader	Hae-Young Ahn	Dosage Form	Capsule
		Dosing Regimen	10 and 15 mg
Date of Submission	June 21, 2004	Route of Administration	Oral
Estimated Due Date of OCPB Review	Nov. 15, 2004	Sponsor	Abbott
PDUFA Due Date	Dec. 22, 2004	Priority Classification	Priority review
Division Due Date	Nov. 15, 2004		

Clin. Pharm. and Biopharm. Information

	"X" if included at filing	Number of studies submitted	Number of studies reviewed	Critical Comments If any
<b>STUDY TYPE</b>				
Table of Contents present and sufficient to locate reports, tables, data, etc.	X			
Tabular Listing of All Human Studies	X			
HPK Summary	X			
Labeling	X			
Reference Bioanalytical and Analytical Methods	X			
<b>I. Clinical Pharmacology</b>				
<b>Mass balance:</b>				
Isozyme characterization:				
Blood/plasma ratio:				
Plasma protein binding:				
<b>Pharmacokinetics (e.g., Phase I) -</b>				
<b>Healthy Volunteers-</b>				
single dose:				
multiple dose:				
<b>Patients-</b>				
single dose:				
multiple dose:				
<b>Dose proportionality -</b>				
fasting / non-fasting single dose:				
fasting / non-fasting multiple dose:				
<b>Drug-drug interaction studies -</b>				
In-vivo effects on primary drug:				
In-vivo effects of primary drug:				
In-vitro:				
<b>Subpopulation studies -</b>				
ethnicity:				
gender:				
pediatrics:	x	2		One single dose pk study (SB240) with 15 mg dose; trough levels at ss in subjects within clinical study SB238
geriatrics:				
renal impairment:				
hepatic impairment:				
<b>PD:</b>				
Phase 2:				
Phase 3:				
<b>PK/PD:</b>				
Phase 1 and/or 2, proof of concept:				
Phase 3 clinical trial:				
<b>Population Analyses -</b>				
Data rich:				
Data sparse:	x	1		
<b>II. Biopharmaceutics</b>				
Absolute bioavailability:				
Relative bioavailability -				

solution as reference:			
alternate formulation as reference:			
<b>Bioequivalence studies -</b>			
traditional design; single / multi dose:			
replicate design; single / multi dose:			
<b>Food-drug interaction studies:</b>			
<b>Dissolution:</b>			
(IVIVC):			
<b>Bio-wavier request based on BCS</b>			
<b>BCS class</b>			
<b>III. Other CPB Studies</b>			
<b>Genotype/phenotype studies:</b>			
<b>Chronopharmacokinetics</b>			
<b>Pediatric development plan</b>			
<b>Literature References</b>			
<b>Total Number of Studies</b>		2	
<b>Filability and QBR comments</b>			
	"X" if yes	Comments	
Application filable ?	x		
Comments sent to firm ?		1. Provide PK parameter dataset for study SB240 2. Provide dataset for the population pk analysis	
QBR questions (key issues to be considered)		1. Basic pharmacokinetics in adolescents 2. Exposure in adolescents compared to that in adults (population pk analysis)	
Other comments or information not included above			
Primary reviewer Signature and Date			
Secondary reviewer Signature and Date			

On June 21, 2004, Abbott submitted a supplement to support the claim for Pediatric Exclusivity for Meridia. This supplement contains study SB240 "An Open-Label, Single-Dose Pharmacokinetic Study of Sibutramine and its Metabolites in Obese Adolescents." and study SB238 "A 12-Month Study to Assess the Safety and Efficacy of Meridia® (Sibutramine Hydrochloride Monohydrate) 10 and 15 mg in Obese Adolescents)".

After a single dose administration of 15 mg sibutramine, the C<sub>max</sub> values of sibutramine, its metabolites M1, M2, M5 and M6 were 2.43, 3.33, 6.27, 13.4, and 12.0 ng/mL, respectively. The AUC<sub>inf</sub> for sibutramine, M1, M2, M5, and M6 were 7.58, 30.4, 93.0, 192, and 242 ng.h/mL, respectively.

At multiple dose administration of 10 mg sibutramine QD, the trough levels of sibutramine at Month 8, 9 and 10 were 0.213, 0.284, and 0.082 ng/mL. The trough levels of M1 at Month 8, 9 and 10 were 0.896, 1.008, 0.730 ng/mL, respectively. The trough levels of M2 at Month 8, 9, and 10 were 2.339, 2.401, and 2.019 ng/mL, respectively.

After multiple dose administration of 15 mg sibutramine QD, the trough levels of sibutramine at Month 8, 9 and 10 were 0.527, 0.493, and 0.373 ng/mL, respectively. The trough levels of M1 at Month 8, 9, and 10 were 1.175, 1.071, and 1.048 ng/mL, respectively. The M2 levels of M2 at Month 8, 9, and 10 were 2.837, 2.747, and 2.886 ng/mL, respectively.

Population pk analysis showed that age class (<= 16 years vs. >16 years) had no impact on the pharmacokinetics of sibutramine.

The sponsor included raw plasma data for both studies. Request for pharmacokinetic parameter dataset for study SB240 and dataset for population analysis will be sent to the sponsor.

Pediatric Exclusivity issue:

According to the agency's written request, the objective/rationale was "to assess the steady-state pharmacokinetics of sibutramine and its active metabolites in 12- to 16-year-old obese adolescents." The study design was "A pharmacokinetic study at doses of 10 mg and 15 mg should be conducted in 12 to 16 year old obese adolescents. This study can be conducted as an appropriate subset of the clinical study using sparse sampling, or as a conventional single-dose pharmacokinetic study supplemented with additional data (trough plasma concentrations at steady-state) in a large group of subjects within a clinical efficacy study." For study evaluation, it says "relevant pharmacokinetic parameters for sibutramine and its active metabolites should be calculated. Tanner stages for the patients in the pharmacokinetic study must be recorded and provided in the study report. Additional information related to pharmacokinetic studies can be found in the Population Pharmacokinetic guidance [[www.fda.gov/cder/guidance/1852fnl.pdf](http://www.fda.gov/cder/guidance/1852fnl.pdf)] and in the draft guidance document on pediatric pharmacokinetic studies [[www.fda.gov/cder/guidance/1970dft.pdf](http://www.fda.gov/cder/guidance/1970dft.pdf)].

Regarding to the study design, the agency requested " a pharmacokinetic study at doses of 10 mg and 15 mg should be conducted in 12 to 16 year old obese adolescents". The sponsor adopted the approach of conducting "a conventional single-dose pharmacokinetic study supplemented with additional data (trough plasma concentrations at steady state) in a large group of subjects within a clinical efficacy study". However, the sponsor did not evaluate the 10 mg dose in the single dose pk study. Thus, the sponsor failed to meet the written request in this regard.

## 4.2 Individual Study Synopsis

## 2.0 Synopsis

<b>Abbott Laboratories</b>	<b>Individual Study Table Referring to Part of the Dossier</b>	<b>(For National Authority Use Only)</b>
<b>Name of Study Drug:</b> Sibutramine hydrochloride monohydrate	<b>Volume:</b>	
<b>Name of Active Ingredient:</b> Sibutramine	<b>Page:</b>	
<b>Title of Study:</b> An Open-Label, Single-Dose Pharmacokinetic Study of Sibutramine and Its Metabolites in Obese Adolescents		
<b>Investigators:</b> Jon L. Ruckle, MD (ending 01 July 2000), Bruce D. Brazina, MD (beginning 01 July 2000)		
<b>Study Site:</b> Northwest Kinetics, LLC, Tacoma, WA		
<b>Publication (Reference):</b> Not applicable.		
<b>Studied Period:</b> 4 days	<b>Phase of Development:</b> 1	
<b>Study Initiation Date:</b> 10 July 2000		
<b>Date First Subject Dosed:</b> 17 July 2000		
<b>Date Last Subject Completed Dosing:</b> 02 August 2000		
<b>Date of Last Study Procedure:</b> 11 August 2000		
<b>Objective:</b> The objective of this study was to assess the pharmacokinetics of sibutramine and its metabolites in obese adolescents.		
<b>Methodology:</b> This Phase 1, single-dose, open-label study was to be conducted in obese adolescent children with a body mass index (BMI) 2 units above the U.S. weighted mean for the 95 <sup>th</sup> percentile (30 kg/m <sup>2</sup> ) based on gender and age. A 15 mg dose (as sibutramine hydrochloride monohydrate) was orally administered as a single 15 mg capsule.		
Blood samples were collected prior to dosing (Time 0), and at 1, 2, 3, 4, 6, 8, 10, 12, 24, 48, and 72 hours post-study drug administration.		
Sibutramine and metabolites M1, M2, M5, and M6 concentrations were determined in plasma by a validated LC-MS method <sup>(b) (4)</sup> The lower limit of quantitation (LOQ) for sibutramine, M1, and M2 was 0.5 ng/mL and the LOQ for M5 and M6 was 1 ng/mL. Samples were analyzed between 10 August 2000 and 01 September 2000 for sibutramine, M1 and M2, and between 14 August 2000 and 27 October 2000 for M5 and M6.		
<b>Number of Subjects:</b>		
Planned: 18; Entered: 18; Completed: 18; Evaluated for Safety: 18; Evaluated for Pharmacokinetics: 18		
For the 18 subjects who participated in the study, the mean age was 13.8 years (ranging from 12 to 16 years), the mean weight was 95.3 kg (ranging from 74.1 to 123.2 kg), the mean height was 167.5 cm (ranging from 159 to 179 cm) and the mean BMI was 33.9 kg/m <sup>2</sup> (ranging from 28.9 to 42.6 kg/m <sup>2</sup> ).		



**Diagnosis and Main Criteria for Inclusion:** Adolescents of either sex, between 12 and 16 years of age, inclusive, and with a BMI 2 units above the U.S. weighted mean for the 95<sup>th</sup> percentile (30 kg/m<sup>2</sup>) based on gender and age. Subjects were in otherwise good health based on medical history, physical examination, 12-lead electrocardiogram (ECG), and clinical laboratory tests. Females of childbearing potential were not pregnant or breast-feeding and, if sexually active, were practicing an acceptable method of birth control.

**Test Product/Reference Therapy, Dose/Strength/Concentration, Mode of Administration and Lot Numbers:**

	Sibutramine
Dosage Form	Hard Gelatin Capsules
Strength (mg)	15
Bulk Product Lot Number	WO11089
Potency (% of Label Claim)	(b) (4)
Manufacturing Site	(b) (4)
Manufacture Date	(b) (4)

**Duration of Treatment:** This was a 4-day study.

**Criteria for Evaluation:**

**Pharmacokinetic:** The pharmacokinetic parameter values of sibutramine and its metabolites (active metabolites: M1 and M2 and inactive metabolites: M5 and M6) were estimated using noncompartmental methods. These included: peak plasma concentration ( $C_{max}$ ), time to maximum drug concentration ( $T_{max}$ ), area under the concentration-time curve to the last measurable time point ( $AUC_{0-T}$ ), area under the concentration-time curve to infinity ( $AUC_{0-\infty}$ ) or  $AUC_{0-T} + C_T/k$ , elimination rate constant ( $k$ ), terminal half-life ( $t_{1/2}$ ) determined by quotient  $0.693/k$ , apparent oral clearance ( $CL/F$ ) and apparent volume of distribution ( $V/F$ ).

**Safety** Vital signs, physical examinations, clinical laboratory tests, ECGs and adverse event (AE) monitoring were performed and assessed.

**Statistical Methods:**

**Pharmacokinetic:** Descriptive statistics including number (N), mean, standard deviation (SD), standard error, minimum (Min), maximum (Max), median, coefficient of variation (CV), and 95% confidence intervals (CIs) were generated and displayed for continuous pharmacokinetic parameters. Additionally, tests and 95% CIs were provided for the comparison of the pharmacokinetic variable data of obese adolescents in this study and obese adults in Study SB3813 (also referred to as PSB3813).

**Safety:** The frequencies and percentages of pre-treatment, treatment-emergent, and overall AEs were summarized by body system and Hoechst Adverse Reaction Terminology (HART term). The laboratory data were summarized descriptively for each laboratory variable. Subjects whose laboratory test results that were normal at baseline and shifted to below or above the normal range during the treatment period were to be reported. Vital signs results were summarized descriptively.

<b>Summary/Conclusions:</b>						
<b>Pharmacokinetic Results:</b> Mean $\pm$ SD pharmacokinetic parameters of sibutramine and its metabolites after a single 15 mg oral dose of sibutramine (N=18) are listed in the following table.						
<b>Pharmacokinetic Parameters (units)</b>		<b>Sibutramine</b>	<b>M1</b>	<b>M2</b>	<b>M5</b>	<b>M6</b>
$T_{max}$	(h)	1.3 $\pm$ 0.8	2.9 $\pm$ 1.0	3.2 $\pm$ 1.3	2.7 $\pm$ 0.8	3.4 $\pm$ 1.5
$C_{max}$	(ng/mL)	2.43 $\pm$ 1.20	3.33 $\pm$ 0.84	6.27 $\pm$ 1.00	13.4 $\pm$ 3.6	12.0 $\pm$ 2.7
AUC <sub>0-T</sub>	(ng·h/mL)	5.42 $\pm$ 2.76	23.4 $\pm$ 8.64	77.0 $\pm$ 20.3	145 $\pm$ 51	208 $\pm$ 61
AUC <sub>0-∞</sub>	(ng·h/mL)	7.58 $\pm$ 2.91	30.4 $\pm$ 10.8	93.0 $\pm$ 23.1	192 $\pm$ 63	242 $\pm$ 62
$t_{1/2}^S$	(h)	1.61 $\pm$ 0.81 <sup>#</sup>	5.21 $\pm$ 2.54	13.4 $\pm$ 7.2	11.3 $\pm$ 6.6	14.6 $\pm$ 8.3
CL/F	(L/h)	2071 $\pm$ 1108	--	--	--	--
V/F	(L)	5406 $\pm$ 2962	--	--	--	--

<sup>S</sup> Harmonic mean  $\pm$  pseudo-standard deviation.  
<sup>#</sup> N=14.



<b>Summary/Conclusions:</b>						
<b>Pharmacokinetic Results:</b> Mean $\pm$ SD pharmacokinetic parameters of sibutramine and its metabolites after a single 15 mg oral dose of sibutramine (N=18) are listed in the following table.						
<b>Pharmacokinetic Parameters (units)</b>		<b>Sibutramine</b>	<b>M1</b>	<b>M2</b>	<b>M5</b>	<b>M6</b>
$T_{max}$	(h)	1.3 $\pm$ 0.8	2.9 $\pm$ 1.0	3.2 $\pm$ 1.3	2.7 $\pm$ 0.8	3.4 $\pm$ 1.5
$C_{max}$	(ng/mL)	2.43 $\pm$ 1.20	3.33 $\pm$ 0.84	6.27 $\pm$ 1.00	13.4 $\pm$ 3.6	12.0 $\pm$ 2.7
$AUC_{0-T}$	(ng·h/mL)	5.42 $\pm$ 2.76	23.4 $\pm$ 8.64	77.0 $\pm$ 20.3	145 $\pm$ 51	208 $\pm$ 61
$AUC_{0-\infty}$	(ng·h/mL)	7.58 $\pm$ 2.91	30.4 $\pm$ 10.8	93.0 $\pm$ 23.1	192 $\pm$ 63	242 $\pm$ 62
$t_{1/2}^S$	(h)	1.61 $\pm$ 0.81 <sup>#</sup>	5.21 $\pm$ 2.54	13.4 $\pm$ 7.2	11.3 $\pm$ 6.6	14.6 $\pm$ 8.3
CL/F	(L/h)	2071 $\pm$ 1108	--	--	--	--
V/F	(L)	5406 $\pm$ 2962	--	--	--	--

<sup>S</sup> Harmonic mean  $\pm$  pseudo-standard deviation.  
<sup>#</sup> N=14.

The results of the statistical comparison between SB240 and SB3813 (a single 15 mg oral dose of sibutramine in obese adults, N=18, mean  $\pm$  SD age = 37  $\pm$  11 yr, BMI = 33.6  $\pm$  3.0 kg/m<sup>2</sup>) are listed in the following table.

Study	Pharmacokinetic Parameter	Central Values*		Ratio of Central Values	95% Confidence Interval	p-value
		Obese Adolescents (SB240)	Obese Adults (SB3813)			
M1	C <sub>max</sub>	3.22	3.68	0.88	0.69 – 1.11	0.264
	AUC <sub>0-T</sub> #	22.1	21.2	1.05	0.74 – 1.47	0.792
	T <sub>max</sub>	2.89	3.58	--	--	0.051
M2	C <sub>max</sub>	6.19	6.12	1.01	0.86 – 1.18	0.896
	AUC <sub>0-∞</sub>	90.5	89.4	1.01	0.86 – 1.19	0.880
	T <sub>max</sub>	3.22	3.53	--	--	0.354
M5	C <sub>max</sub>	12.94	24.53	0.53	0.44 – 0.63	<0.001 <sup>+</sup>
	AUC <sub>0-∞</sub>	183.1	261.6	0.70	0.58 – 0.85	0.001 <sup>+</sup>
	T <sub>max</sub>	2.72	3.06	--	--	0.173
M6	C <sub>max</sub>	11.7	20.2	0.58	0.47 – 0.71	<0.001 <sup>+</sup>
	AUC <sub>0-∞</sub>	233.5	315.4	0.74	0.61 – 0.90	0.004 <sup>+</sup>
	T <sub>max</sub>	3.44	3.22	--	--	0.573

\* Geometric means for C<sub>max</sub>, AUC<sub>0-T</sub>, and AUC<sub>0-∞</sub>; arithmetic mean for T<sub>max</sub>.

# t<sub>1/2</sub> for M1 was not estimable for SB3813; therefore, AUC<sub>0-T</sub> of M1 was used for the comparison between the two studies instead of AUC<sub>0-∞</sub>.

+ Statistically significant (p ≤ 0.05).

In SB3813, very few samples had measurable sibutramine concentrations, with LOQ being 10 ng/mL. A cross-study comparison for sibutramine, therefore, was not carried out.

**Safety Results:** Nine (9/18, 50.0%) subjects reported at least one treatment-emergent AE. AEs reported by three or more subjects were headache (five subjects, 27.8%) and dizziness (three subjects, 16.7%). All remaining AEs were reported by a maximum of 5.6% of subjects (one subject).

No deaths, other serious adverse events (SAEs), or premature discontinuations due to AEs occurred during the study. An increase in systolic blood pressure was reported in two subjects. In one subject the blood pressure change occurred two hours post-dosing in association with a pulse increase reported as AE of mild tachycardia. In the second subject, the change in systolic blood pressure occurred 48 hours post-dosing with no significant changes in pulse. The cases of pulse and systolic blood pressure increases resolved spontaneously. Results of other safety analyses, including individual subject changes and individual clinically significant values for ECGs and physical examination, were unremarkable.

The majority of the treatment-emergent AEs were assessed by the investigator as unrelated to the study drug and all treatment-emergent AEs were mild in severity.

**Conclusions:** After the administration of a single 15 mg oral dose of sibutramine in obese adolescents, sibutramine was rapidly absorbed, and underwent extensive first-pass metabolism. Between the two pharmacologically active metabolites with similar potency, M1 exposure was much lower than M2. The

values of  $AUC_{0-\infty}$  of the secondary glucuronide conjugates M5 and M6 are more than 2-fold higher than that for M2.

The pharmacokinetic profiles for sibutramine active metabolites (M1 and M2) were similar between obese adolescents and obese adults. Although the exposure ( $C_{max}$  and  $AUC_{0-\infty}$ ) of M5 and M6 was lower in obese adolescents than that in obese adults, the difference is not likely to be clinically relevant.

A single 15 mg dose of sibutramine was generally well tolerated by the subjects. No clinically significant physical examination results or laboratory measurements were observed during the course of the study. Two findings of increase in systolic blood pressure were reported. Only in one case, the increase in systolic blood pressure was recorded concomitantly to an event of pulse increase.

The proportion of subjects reporting at least one treatment-emergent AE was 50.0%. The most common treatment-emergent AEs (reported by three or more subjects) were headache and dizziness. All of treatment-emergent AEs were considered by the investigator to be mild in severity and resolved spontaneously. The majority of the treatment-emergent AEs were rated as unrelated to study drug by the investigator.

There were no deaths, other serious AEs, or premature discontinuations due to AEs. Other than the reported single event of pulse increase and the two findings of increased systolic blood pressure, the results of other safety analyses, including individual subject changes and individual clinically significant values for vital signs, ECGs and physical examinations, were unremarkable.

**Date of Report:** 10 November 2003

## 2.0 Synopsis

<b>Name of Company:</b> Abbott Laboratories	<b>Individual Study Table Referring to Item of the Submission:</b>  <b>Volume:</b>  <b>Page:</b>	<b>(For National Authority Use Only)</b>
<b>Name of Study Drug:</b> Meridia <sup>®</sup>		
<b>Name of Active Ingredient:</b> Sibutramine hydrochloride monohydrate		
<b>Title of Study:</b> A 12-Month Study to Assess the Safety and Efficacy of Meridia <sup>®</sup> (sibutramine hydrochloride monohydrate) 10 and 15 mg in Obese Adolescents		
<b>Investigators:</b> Multicenter; the coordinating Investigator was Dr. Robert Berkowitz; 33 investigator sites enrolled subjects (a list of all participating investigators is included in <a href="#">Appendix 16.1__4</a> ).		
<b>Study Sites:</b> Multicenter (United States)		
<b>Publications:</b> None		
<b>Study Period (Years):</b> Initiation Date: 19 July 2000 Completion Date: 18 February 2002	<b>Phase of Development:</b> 3	
<b>Objectives:</b> The objectives of this study were: 1) To assess the efficacy and safety of Meridia <sup>®</sup> (sibutramine hydrochloride monohydrate) 10 and 15 mg in 400 obese adolescents (300 sibutramine, 100 placebo) ages 12-16 years with a BMI lower limit of inclusion 2 units above the U.S. weighted mean for the 95 <sup>th</sup> percentile based on age and gender, to a BMI upper limit of 44 kg/m <sup>2</sup> . 2) To assess the steady state pharmacokinetics of sibutramine and its active metabolites in 12 to 16 year old obese adolescents.		
<b>Methodology:</b> This was a double-blind, randomized, placebo-controlled, multicenter, parallel arm, 12-month, dose titration study to evaluate the safety and efficacy of sibutramine 10 and 15 mg daily when given to obese adolescents. The study consisted of a screening period and a 52-week double-blind treatment period. Four hundred subjects were to be randomized to either sibutramine or placebo in 3:1 fashion. All subjects received instruction in lifestyle modification to include healthy eating behavior, exercise, and bodyweight control.		

**Methodology (continued):**

All subjects randomized remained on 10 mg of study drug for the first 6 months. At 6 months, all subjects who had not lost > 10% of their initial BMI were to be up-titrated to 15 mg of study drug for the duration of the study. Subjects were to be seen weekly for the first 2 weeks, then every 2 weeks for the next 10 weeks, and then monthly (except for an additional visit at Month 6.5) thereafter until study completion.

Efficacy measurements included the change from Baseline in BMI, bodyweight, waist circumference, body composition *via* dual x-ray absorptiometry (DXA), and fasting lipid and glycemic variables.

Steady-state pharmacokinetics included measurement of plasma trough concentrations of sibutramine and its active metabolites M1 and M2 for qualitative comparison to adult reference studies.

Safety measurements included adverse events, laboratory variables, vital signs and ambulatory blood pressure monitoring (ABPM) data, electrocardiography (ECG) parameters, echocardiography, focused cardiovascular and general physical examination, growth (assessed as height) and sexual maturation (assessed by Tanner staging)

Behavior, cognitive function (*i.e.*, learning, memory, and psychometrics) and Quality-of-Life measurements were assessed using the following tools: Child Depression Inventory (CDI), Piers-Harris Children's Self-Concept Scale, Eating Inventory, Child Behavior CheckList (CBCL), Impact of Weight on Quality-of-Life Questionnaire (IWQOL) and IWQOL-Lite both modified for adolescents and the Pediatric Quality-of-Life Inventory (Peds QL™). The IWQOL-Lite is another way of scoring the IWQOL. It utilizes three domains: physical function, self-esteem and public distress.

**Number of Subjects (Planned and Analyzed):**

The planned sample size was 400 obese adolescents. Randomized: 498 (368 sibutramine, 130 placebo). Full Analysis Set: 490 (363 sibutramine, 127 placebo).

**Diagnosis and Main Criteria for Inclusion:**

Obese adolescents ages 12-16 years, with BMI lower limit of inclusion 2 units above the United States weighted mean for the 95<sup>th</sup> percentile based on age and gender, to an upper limit for BMI of 44 kg/m<sup>2</sup>. Efforts were to be made to obtain a study population comprising 50-75% females and at least 30% African-Americans across the study.

**Test Product, Dose/Strength/Concentration, Mode of Administration and Lot Number:**

Sibutramine HCl 10 mg capsule administered once daily orally, batch number W011087 and W011088; Sibutramine HCl 15 mg capsule administered once daily orally, batch number W013643.

**Duration of Treatment:**

12 months

**Reference Therapy, Dose and Mode of Administration, Lot Number:**

Placebo capsule administered once daily orally, batch number 216-K150-P5-0399.

**Criteria for Evaluation:****Efficacy:**

The primary outcome measure for efficacy assessment was the absolute change in BMI from Baseline to Endpoint. The secondary efficacy variables for this study were the percent change from Baseline in BMI; BMI outcome score at Endpoint, the proportions of subjects achieving  $\geq 5\%$  and  $\geq 10\%$  BMI reduction from Baseline, the proportions of subjects achieving  $\geq 5\%$  and  $\geq 10\%$  reduction in bodyweight, the absolute and percent change from Baseline in bodyweight; the absolute change from Baseline in waist circumference, the absolute change from Baseline in body composition variables as measured by DXA, and the absolute and percent change from Baseline in fasting lipid variables (triglycerides, HDL cholesterol, LDL cholesterol and total cholesterol) and fasting glycemic variables (glucose, insulin, HOMA).

An outcome score was assessed for percent change in BMI using the following categories:  $\geq 20\%$  decrease of Baseline BMI;  $\geq 15\%$  to  $< 20\%$  decrease;  $\geq 10\%$  to  $< 15\%$  decrease;  $\geq 5\%$  to  $< 10\%$  decrease;  $> 0\%$  to  $< 5\%$  decrease; no change; or increase. Two further categories, for subjects who withdrew from the study, were defined such that subjects who withdrew for lack of efficacy or adverse event, and subjects who died, were assigned to the worst category, and all other withdrawals were assigned to the second worst category.

**Pharmacokinetics:**

Trough plasma concentrations of sibutramine and its main metabolites in an adolescent population were qualitatively compared to those in adults from previous studies.

**Safety:**

The following safety parameters were summarized and analyzed for significance between treatment differences as appropriate: adverse events, routine laboratory parameters, vital signs and ABPM data, ECG parameters, echocardiography, focused cardiovascular and general physical examination, growth (assessed as height), sexual maturation (assessed by Tanner staging) and current and concurrent medications.

Behavior, cognitive function (*i.e.*, learning, memory, and psychometrics) and Quality-of-Life were to be assessed by using the following validated, written instruments: CDI, Piers-Harris Children's Self-Concept Scale, Eating Inventory, CBCL, IWQOL and IWQOL-Lite both modified for adolescents and the Peds QL™. These tools were to be self-administered by the subjects except for the CBCL, which was to be completed by the guardian/parent at the time of the office visit.

**Statistical Methods:****Efficacy:**

The primary measure of efficacy was the absolute change from Baseline to Endpoint in BMI for the full analysis set. The null hypothesis of no difference between sibutramine and placebo was tested using an ANCOVA model with factors for treatment group, center, age and gender, and with Baseline BMI as a covariate. The adjusted means and standard errors derived from the main effects model for each treatment group, as well as an estimate and 95% confidence interval for the difference between treatments, were reported. A separate test for the treatment group-by-center interaction was performed and significance determined by reference to the 10% level. If the interaction was statistically significant, further investigation was to be carried out to assess the impact of the interaction on the estimate of treatment effect.



**Statistical Methods (continued):**

The ANOVA model specified in the protocol, for the absolute change from Baseline to Endpoint in BMI with factors for treatment group and center, was also presented for information and to assess the robustness of the primary efficacy analysis using ANCOVA. Any differences in interpretation of the results between the 2 methods were to be investigated. If warranted by differences observed, this method may have been used to repeat each of the appropriate secondary analyses described below.

The ANCOVA model with factors for treatment group, center, age and gender and with the Baseline value of the variable being analyzed as a covariate was also formed to test for differences between sibutramine and placebo for:

- Percent change from Baseline to Endpoint in BMI;
- Absolute and percent change from Baseline to Endpoint in bodyweight;
- Absolute change from Baseline to Endpoint in waist circumference;
- Absolute change to Month 6/Endpoint in DXA body composition variables;
- Absolute and percent change from Baseline to Endpoint in serum lipids; and
- Absolute and percent change from Baseline to Endpoint in glycemic parameters.

Each of these analyses performed on the change from Baseline to Endpoint for the full analysis set was repeated for the change from Baseline to Month 12 for the completers set.

ANOVA models with factors for treatment group and gender were performed for the absolute change from Baseline to Endpoint for the full analysis set for each efficacy variable, and for the percentage change for BMI and bodyweight.

An analysis of outcome was performed on percent change in BMI using the following categories:  $\geq 20\%$  decrease of Baseline BMI;  $\geq 15\%$  to  $< 20\%$  decrease;  $\geq 10\%$  to  $< 15\%$  decrease;  $\geq 5\%$  to  $< 10\%$  decrease;  $> 0\%$  to  $< 5\%$  decrease; no change; increase in BMI; withdrew for non-treatment related reasons; and withdrew for treatment-related reasons. Additionally, the proportions of subjects who achieved  $\geq 5\%$  and  $\geq 10\%$  reduction in BMI from Baseline (5% and 10% BMI responders, respectively), and  $\geq 5\%$  and  $\geq 10\%$  reduction in bodyweight from Baseline (5% and 10% bodyweight responders, respectively) were summarized.

Subgroup presentations, shift tables for lipid and glycemic variables and additional presentations by final dose received were provided.

**Pharmacokinetics:**

Pre-dose (trough) plasma concentrations of sibutramine, and its active metabolites (M1 and M2) collected from a subset of subjects at Months 8, 9 and 10 were summarized descriptively by month, as well as by subject and dose. This descriptive summary included means, medians, standard deviations, coefficients of variation, range, and 95% confidence intervals for the central values (for M1 and M2 only).

Trough samples of M1 and M2 were analyzed using a linear mixed effect model. The model included fixed effects for dose, month, gender, race, Tanner stage of male/female puberty, and a random effect for subject. Body mass index and age were included in the model as covariates. The adolescent concentration data were also compared to the data collected from a trial in obese adults, Study BPI852, using a mixed effect model.

**Statistical Methods (continued):****Safety:**

Treatment-emergent adverse events, defined as those reported to have started on or after the day of first dose of study medication, were tabulated in the main report. All serious adverse events reported as started prior to the day of first dose were also summarized; all non-serious pre-study events were listed in an appendix to the study report only.

Adverse events were analyzed by presenting frequency and percentage of subjects with adverse events. For specific adverse event COSTART V preferred terms, each preferred term was counted only once per subject, and if different categories (*e.g.*, for severity or relationship to trial drug) occurred, the worst one was taken. Fisher's Exact Test was used to test for differences in incidence of reporting each preferred term between treatment groups.

Summary tables were prepared for adverse events which presented the number and percentage of subjects (for the safety analysis set) by treatment group with the following types of treatment-emergent adverse events:

- Summary of any adverse event, any adverse event leading to death, any serious adverse event, any adverse event resulting in withdrawal, any adverse event resulting in a dose reduction or interruption, any severe adverse event, and any adverse event with possible, probable or definite relation to study drug;
- Adverse events by preferred term. In addition, subject identifiers were given to each preferred term;
- Common adverse events, defined as those with a relative frequency of at least 5% in at least one of the treatment groups;
- Adverse events by severity; and
- Adverse events by relationship to trial drug.

For each of the hematology and serum chemistry variables (except for glycemic and lipid variables), the treatment groups were compared for the change from Baseline to Endpoint for all subjects, using a one-way ANOVA model. Both mean and median changes were presented.

Shift tables detailing changes in normality/abnormality status from Baseline to Endpoint, according to the Very High/Very Low criteria (modified FDA guidelines), were generated for each laboratory variable (including glycemic and lipid variables).

For all subjects with at least one potentially clinically significant value for a laboratory variable, defined according to the Very High/Very Low criteria (modified FDA guidelines), all values recorded for that laboratory variable for that subject during the study were listed.

Vital signs were described by summary statistics (n, mean, standard deviation, minimum, median, maximum) by visit, and for the changes from Baseline to each time point for the full analysis set, the observed analysis set, and study completers. Changes to the minimum and maximum values recorded for each subject were also summarized.

The change from Baseline to Endpoint for the full analysis set, and to Month 12 for the completers set, in vital sign variables was analyzed using ANCOVA with a factor for treatment group, and the Baseline value included as a covariate. Adjusted means for the treatment groups were presented, with 95% confidence intervals for the difference. These analyses were repeated for subjects achieving < 5%, at least 5%, and also at least 10% reduction in BMI at Endpoint.



**Statistical Methods (continued):**

**Safety (continued):**

For all subjects in the safety set with at least one potentially clinically significant value for a vital signs variable, defined according to the Very High/Very Low criteria (modified FDA guidelines), all values recorded for that vital signs variable for that subject during the study were listed.

Subjects in the safety set identified as "outliers" with respect to their vital sign data, as defined in the study protocol, were summarized categorically and analyzed using logistic regression.

Additional presentations for vital signs data described the whole study population, and identified "outliers" in detail.

Summary statistics for the change from Baseline to Month 7/Endpoint were provided for each ABPM variable. Plots illustrated mean SBP and DBP by 3-hour intervals at Baseline and Endpoint by treatment group. Rank ANCOVA models were used to analyze one change from Baseline to Endpoint in each behavior, cognitive function and Quality-of-Life Variable.

Summary statistics and analyses of the change from Baseline to Endpoint in ECG heart rate, and ECG PR, QRS, QT and QTc intervals, were presented and performed similarly to the vital sign variables for the safety set.

For all subjects with at least one potentially clinically significant value for an ECG variable, defined according to the Very High/Very Low criteria (modified FDA guidelines), all values recorded for that ECG variable for that subject during the study were listed.

For the subset of subjects for whom echocardiography was performed, the number and frequency of subjects with aortic insufficiency (AI), mitral regurgitation (MR), AI and/or MR, left-sided valvular heart disease, pulmonary insufficiency (PI), tricuspid regurgitation (TR), PI and/or TR was presented at Baseline and at Month 12 or premature termination. For the subjects without each condition listed above at Baseline, logistic regression with factors for treatment group, center, age and gender, was used to compare the new occurrence at Month 12 or premature termination of each condition separately between treatment groups. The odds ratio of a new recording of each condition in the sibutramine treatment group compared to the placebo treatment group was presented with the associated 90% confidence interval.

**Summary/Conclusions:**

(b) (4)

**Summary/Conclusions (continued):**

(b) (4)



**Pharmacokinetic Results:**

In adolescents, doses of 10 and 15 mg per day of sibutramine produced concentrations of M1 and M2 that were similar to those in a previous adult clinical study. With regard to M2, a trend towards increasing trough concentrations with increasing dose was observed in adolescents. In adolescents, no significant differences in steady-state concentrations with respect to month, age, Tanner score or BMI were noted. As previously observed in adults, females tended to have higher concentrations compared to males. Some differences in race were noted, although these observations are limited by the smaller number of subjects in each group other than Caucasian. Since the weight-loss effect and change in vital signs variables from Baseline to Endpoint were similar across different genders and different races, the small differences in pharmacokinetics across these sub-populations are not clinically significant.

**Summary/Conclusions:****Safety Results:**

Sibutramine treatment was well tolerated in obese adolescents. The mean exposure to study drug was 294 days in the sibutramine group and 254 days in the placebo group. In those subjects who were titrated to sibutramine 15 mg at Month 6 the mean exposure to sibutramine 15 mg was 159 days.

At least one treatment-emergent adverse event was reported during the study for 89% of subjects in the sibutramine group and 85% of subjects in the placebo group.

Treatment-emergent adverse events for tachycardia were reported in 13% of subjects in the sibutramine group compared to 6% of subjects in the placebo group ( $p = 0.049$ ).

The reported incidences of other treatment-emergent adverse events of clinical concern (*i.e.*, depression, syncope, chest pain, arrhythmia and extrasystoles) each occurred in  $\leq 1.5\%$  of subjects ( $\leq 5/368$  in the sibutramine group and  $\leq 2/130$  in the placebo group). There were no treatment-emergent adverse events for myocardial infarction, transient ischemic attack, stroke or major psychiatric disorder other than depression.

There was no evidence of dose titration effect on new onset of treatment-emergent adverse events.

No subject died during the study. Serious adverse events were reported for 3% of subjects in the sibutramine group and 1% of subjects in the placebo group ( $p = 0.303$ ).

The reported incidence of serious treatment-emergent adverse events with descriptions of suicide attempt, suicide ideation and suicide idealization was 3/368 (1%) of subjects in the sibutramine group and 1/130 (1%) of subjects in the placebo group. Suicide attempt (COSTART term: suicide attempt) was reported for one sibutramine (Subject 1006) and one placebo (Subject 2505) subject. Suicidal ideation (COSTART term: depression) was reported for one sibutramine subject (Subject 106); this subject also had a history of depression. Suicide idealization (COSTART term: depression) was reported for one sibutramine subject (Subject 2223). All four events were reported to be unlikely related or unrelated to study drug. All of these subjects were prematurely withdrawn from the study.

A total of 34 treatment-emergent adverse events resulting in premature discontinuation of study drug were reported in 30 subjects (6% of subjects in the sibutramine group and 5% of subjects in the placebo group) ( $p = 0.832$ ).

**Summary/Conclusions (continued):****Safety Results (continued):**

Tachycardia and hypertension were the treatment-emergent adverse events most commonly resulting in premature discontinuation of study drug.

The mean changes from Baseline to Endpoint in hematology and chemistry variables other than those considered efficacy in each treatment group were small and not considered clinically significant.

In the full analysis set, the mean absolute changes in vital signs from Baseline to Endpoint were -2.1 mmHg in both the sibutramine and placebo treatment groups for SBP; -0.1 and -1.1 mmHg, respectively for DBP; and -0.2 and -1.8 bpm, respectively for pulse rate. The differences between treatment groups for the changes in SBP, DBP and pulse rate were not statistically significant ( $p = 0.988$ ,  $p = 0.136$  and  $p = 0.055$ , respectively). Similar vital sign changes were observed from Baseline to Month 12 for the completers set.

The mean absolute changes in vital signs from Baseline to each study visit were similar between treatment groups and were not clinically significant. The mean absolute changes in vital signs during the latter half of the study increase with continued drug exposure in either the sibutramine or placebo treatment group. Dose titration from 10 mg to 15 mg did not affect the mean absolute changes in vital sign measurement, within the group of subjects that received dose up-titration.

The incidence of protocol-defined vital sign outliers was 32% of subjects in the sibutramine group and 16% of subjects in the placebo group ( $p = 0.001$ ). The incidence of SBP outliers was 5% for the sibutramine group and 4% for the placebo group ( $p = 0.548$ ). The incidence of DBP outliers was 12% for the sibutramine group and 8% for the placebo group ( $p = 0.208$ ). The incidence of pulse rate outliers was 20% for the sibutramine group and 6% for the placebo group ( $p < 0.001$ ).

The occurrences of outlier events were not affected by final dose of sibutramine.

The mean changes in ABPM variables (mean daytime, mean nighttime, mean 24-hour and mean daytime-mean nighttime) were similar between treatment groups. Normal diurnal variation was maintained during sibutramine therapy.

The mean changes from Baseline to Endpoint in ECG intervals (PR, QRS, QT, QTc and ventricular heart rate) were not clinically significant. ECG evaluations demonstrated no evidence of clinically significant QTc prolongation.

Echocardiogram evaluations showed that there were no cases of left-sided valvular heart disease in either treatment group.

Echocardiogram evaluations of the mean changes in interventricular septal thickness in diastole, left ventricular mass and left ventricular posterior wall thickness in diastole showed similar improvements between treatment groups.

**Summary/Conclusions (continued):**

**Safety Results (continued):**

Growth, assessed as percentile height for age and gender, and sexual maturation, assessed by Tanner staging were not affected by sibutramine therapy.

Behavior, cognitive function (*i.e.*, learning, memory, and psychometrics) and Quality-of-Life were assessed using a comprehensive battery of well validated instruments. Few statistically significant differences between the sibutramine and placebo treatment groups were noted. When statistically significant differences between treatment groups were observed, generally the differences favored the sibutramine group.

Sibutramine therapy had little impact on psychological and emotional well-being of adolescents and no effect on measures of physical health, social functioning, and measures of delinquency or aggressive behavior. Sibutramine therapy was not associated with depressive symptoms or new onset depression. Sibutramine therapy had a positive effect on attention and school functioning, and the ability to modify eating behavior.

**Conclusions:**

(b) (4)  
The study population was diverse in age, sex, and ethnic background, making these results relevant to obese adolescents in a variety of clinical settings. Similar to sibutramine treatment in obese adults, close monitoring of vital signs during therapy is warranted.

-----  
**This is a representation of an electronic record that was signed electronically and  
this page is the manifestation of the electronic signature.**  
-----

/s/

-----  
Wei Qiu  
12/1/04 04:22:19 PM  
BIOPHARMACEUTICS

Hae-Young Ahn  
12/2/04 01:02:40 PM  
BIOPHARMACEUTICS